

timloc
building products

HANDBOOK

NEW



Sustainable building products
from ground level up to the roof ridge

We are a **British manufacturer** supplying the building industry for almost 60 years



At Timloc Building Products we manufacture and supply sustainable building products from ground level right up to the roof ridge, from our state-of-the-art manufacturing facility in East Yorkshire.

We are committed to sustainable manufacturing and over 75% of products are made from recycled plastics. Our products are designed for use throughout the lifespan of a building and are recyclable at the end of the building life.

GET SOCIAL



FIND US ON:



A photograph of a white Timloc truck with a blue trailer driving on a road. The trailer has the 'timloc building products' logo. The background is a lush green landscape with trees and a residential area in the distance. Overlaid on the image are promotional graphics: a banner that says 'FREE NEXT DAY DELIVERY' and a location pin icon containing the text 'on orders over £100 to branch or £150 to site'. At the bottom, there is a disclaimer: '*All orders placed before 12pm Monday - Friday will be delivered the next working day. Applicable to standard stock items only, please see individual product pages for more information.'

EQUALITY, DIVERSITY & INCLUSION

BUILDING A FAIRER FUTURE

We're committed to making the construction industry more inclusive, which is why we're part of the Construction Inclusion Coalition (CIC). The sector still lacks diversity and change requires real collaboration. Through the CIC's Built on Better Pledge, we're working to inspire future talent, share resources and help create a healthier, more welcoming industry for everyone.



The construction industry is vital to the UK's growth, yet it remains one of the least diverse sectors. With only 15% women (2% on-site), 6% ethnic minority representation, and 6% workers with disabilities, the industry risks missing out on a wealth of talent and perspective. We're proud to uphold a balanced gender split across all teams, including at management level, demonstrating our commitment to equality in practice.

SUSTAINABILITY

LEADING BY EXAMPLE



Scan the QR code to learn more

At Timloc Building Products, we take our responsibility for the environment very seriously and are committed to making positive steps to help reduce plastic waste within the building industry. In 2021, we became the first carbon neutral building products manufacturer in the UK.

Our products are designed for use throughout the lifespan of a home and are recyclable at the end of the building life. We have implemented a circular economy for the production and consumption of many Timloc products. This regenerative system means recycled materials are being used to make recyclable products.

Timloc Building Products is part of Alumasc Group Plc, a UK provider of sustainable building systems and solutions. Alumasc has been awarded the London Stock Exchange Green Economy Mark, recognising organisations generating over 50% of revenue from environmental solutions. **Together, we're shaping a greener future for the built environment.**



100% renewable electricity powering our operations



100% waste diverted from landfill



100% recyclable packaging



Over 75% of products manufactured using recycled materials

CONTENTS

CONSTRUCTION ACCESSORIES

Invisiweep	8
Invisiweep NC	8
Cavity Wall Weep	9
Drill Vent	9
Insulation Retaining Discs	9
1201 Telescopic Underfloor Ventilator	10
1201XL Telescopic Underfloor Ventilator	10
1201XL+ Telescopic Underfloor Ventilator	10
Telescopic Underfloor Ventilator Accessories	12
Airbricks	12

THROUGH-WALL VENTILATION

External Cows	15
Cavity Sleeves	15
Adapt-Air	16
Aero Core	18
Internal Plastic Grilles	20
Internal Metal Grilles	20

CAVITY TRAYS

Everdry Adjustable Stepped - Brickwork	24
Everdry Stepped - Stonework	25
Everdry Stepped - Blockwork	26
Everdry Stepped - Brickwork - Lead Attached	27
Everdry Stepped - Stonework - Lead Attached	28
Everdry Stepped - Blockwork - Lead Attached	29
Inter-loc Horizontal	30
Inter-loc Horizontal - Lead Attached	31
System 2000 Horizontal	32
System 2000E Horizontal - Refurbishment	33
System 2000 Horizontal - Lead Attached	34
General Purpose Trays	35
Horizontal Parapet Trays	36
Lintel Trays	37
Threshold Trays	37
Door & Window Trays	38
Purpose Made Trays	38

TOP HATS, GAS BARRIERS & DPC

Top Hats	41
Flexible Top Hats	41
1201 Top Hat	41
Damp Proof Coursing	42
Radon Sump	43
Accessories	43

CAVITY CLOSERS & STOP SOCKS

Cavity Closers & Stop Socks Table	45
Thermo-loc Multi Cavity Closer	46
Thermo-loc + Cavity Closer	47
Thermo-loc + FX Cavity Closer	48
Thermo-loc FR30 Cavity Closer	49
Thermo-loc FR60 Cavity Closer	50
Thermo-loc FR60+ Cavity Closer	50
FRSTOP Stop Sock Masonry to Masonry	52
TIMFRSTOP Stop Sock Timber to Masonry	53
TTFRSTOP Stop Sock Timber to Timber	54
PWFRSTOP Party Wall Cavity Stop Sock Masonry to Masonry	55
PWTIMFRSTOP Party Wall Cavity Stop Sock Timber to Masonry	56

ACCESS PRODUCTS

Loftite Hinged Drop Down Loft Door	58
Plastic Push-up Loft Door	60
Plastic Hinged Drop Down Loft Door	60
Z-Series Metal 1 Hour Fire Rated Loft Door	61
Loft-loc Loft Door Poles	61
Plastic Access Panels	62
Airtight Plastic Access Panels	62
Z-Series Metal Access Panels	63
Metal 1 Hour Fire Rated Access Panels	63

RAD-SEAL

Rad-seal 10 Face-Fix Radiator Pipe Guide & Seal	65
Rad-seal 15 Face-Fix Radiator Pipe Guide & Seal	65
Rad-seal Recessed Radiator Pipe Guide & Seal	65

ROOFLINE

Push-In Soffit Vent	68
Soffit Vent Strip	68
2-in-1/3-in-1 Eaves Vent	69
Felt Support Tray	69
Eaves Bird Comb Filler	69
300mm Over Fascia Vent	70
1m Over Fascia Vent	70
Corbel Vent	70
Rafter Roll	71
6m Eaves Vent Pack	71
Lap Vent	72
PbFree Lead-free Flashing	73
6m 10m Dry Fix Ridge Kit	74
3m 6m Integrated Dry Ridge Kit	75
Dry Fix Clay Ridge Kit	75
Dry Fix Hip Kit	76
Hip Tray Pack	76
Hip Clips Kit	76
Universal Caps & Brackets - Dry Fix Verge	77

ROOFLINE CONTINUED

Ambi-verge Universal Dry Fix Verge System	77
Handed Dry Fix Verge System	78
Interlocking Plain Edge Dry Verge	78
Thin Leading Edge Dry Verge	79
Dry Fix Continuous Verge System	79
Ambi-Soakers - Plain	81
Ambi-Soakers - Interlocking Plain	81
Ambi-Soakers - Slate	81
Ambi-Soakers - Thin Leading Edge	81
Ambi-Soakers - Flat	81

INVENTIVE ROOF TILE & SLATE VENTS

Inventive Compatibility Chart	84
Castellated Tile Vent	86
Double Pantile Tile Vent	86
Double Roman Tile Vent	86
Flat Edge Tile Vent	87
Non-Profile Tile Vent	87
Thin Leading Edge Tile Vent	87
Mini Castellated Tile Vent	88
Single Pantile Tile Vent	88
Interlocking Plain Tile Vent	88
Plain Tile Vent	89
Low-Profile Plain Tile Vent	89
Slip Plain Tile Vent	89
Universal Tile Vent	90
Universal 22,000 Tile Vent	90
Universal Inline Slate Tile Vent	91
Small Inline Slate Tile Vent	91
Hooded Slate Tile Vent	91
Universal Hooded Slate Tile Vent	91
Standard Roof Tile Vent Adapter	92
Plain Roof Tile Vent Adapter	92
Inline Slate Vent Adapter	92
Hooded Slate Vent Adapter	92
Multi Stepped Duct Adapter	92
110mm Flexi-Pipe Kits	93
Inventive Breakdown Table	94

METER BOXES

Electric - Recessed	96
Electric - Surface Mounted	96
Electric 3 Phase - Recessed	96
Electric 3 Phase - Surface Mounted	96
Gas - Recessed	97
Gas - Surface Mounted	97
Gas - Universal Smart	97
Hockey Sticks	97
Replacement Parts	97

HEDGEHOG HIGHWAY

Hedgehog Highway	99
------------------	----

Visit the Timloc website for further information including:

DATASHEETS | INSTALLATION ADVICE
COMMODITY CODES | CERTIFICATIONS

**SCAN TO VIEW
ONLINE**





CONSTRUCTION ACCESSORIES



INVISIWEEP	8
INVISIWEEP NC	8
CAVITY WALL WEEP	9
DRILL VENT	9
INSULATION RETAINING DISCS	9
TELESCOPIC UNDERFLOOR VENTS	10
TELESCOPIC UNDERFLOOR VENT ACCESSORIES	12
AIRBRICKS	12

SCAN TO VIEW
THE RANGE ONLINE



WALL WEEPS

INVISIWEEP

The almost invisible wall weep



USE

- Low-profile wall weep for discharging water from external walls
- Suitable for external wall depths of 102.5mm
- 500mm extension tube available to accommodate deeper walls

DIMENSIONS

- 65mm (H) x 10mm (W) x 102mm (L) extension available to accommodate deeper walls

IW500EX provides up to a **500mm extension** and can be cut to size. Slots directly into the front of the Invisiweep.

PRODUCT CODE	COLOUR	PACK QTY	LEAD TIME
IW500EX	Clear	10	NWD



Scan to view product video

COLOUR	50 QTY CODE	200 QTY CODE	LEAD TIME
Black	IW50BL	IW200BL	Next Working Day
Blue Black	IW50BB	IW200BB	Next Working Day
Brown	IW50BR	IW200BR	Next Working Day
Buff	IW50BU	IW200BU	Next Working Day
Clear	IW50CL	IW200CL	Next Working Day
Grey	IW50GR	IW200GR	Next Working Day
Terracotta	IW50TE	IW200TE	Next Working Day
White	IW50WH	IW200WH	Next Working Day

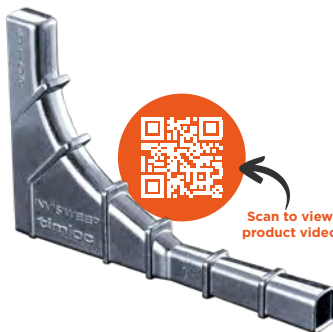

Scan to view product video

PRODUCT CODE	PACK QTY	LEAD TIME
ZIN50	50	Next Working Day



The non-combustible wall weep

USE

- In external masonry walls
- When a building storey is above 18 metres from ground level, non-combustible materials must be used
- When a building storey is above 11 metres from ground level, non-combustible materials must be used (Scotland)
- At ground floor slab level
- Within cavity tray systems
- Over external lintels

DIMENSIONS

- 65mm (H) x 10mm (W) x 102mm (L)

CAVITY WALL WEEP



165mm²
AIRFLOW

USE

- Multi-function cavity wall weep designed for cavity ventilation and reliable discharge of water from inside cavity walls
- Where a cavity must be ventilated
- Where a cavity tray system is installed
- Over external lintels
- At ground floor slab level
- On external brick, block or stone walls of 100mm+ thickness

DIMENSIONS

- 65mm (H) x 10mm (W) x 100mm (L)

COLOUR	PACK QTY	PRODUCT CODE	LEAD TIME
Black	50	1143BL	Next Working Day
Blue Black	50	1143BB	Next Working Day
Brown	50	1143BR	Next Working Day
Buff	50	1143BU	Next Working Day
Clear	50	1143CL	Next Working Day
Grey	50	1143GR	Next Working Day
Terracotta	50	1143TE	Next Working Day
White	50	1143WH	Next Working Day



The 1144 offers a **50mm extension** and connects directly to the 1143 cavity wall weep.

PRODUCT CODE	COLOUR	PACK QTY	LEAD TIME
1144	Clear	50	NWD



355mm²
AIRFLOW



DRILL VENT

USE

- Retrospective cavity wall weep
- Ideal for venting timber framed buildings
- Both high and low-level ventilation and drainage to an external cavity system

DIMENSIONS

- 40mm (H) x 25mm (D) x 80mm (L)

COLOUR	PACK QTY	PRODUCT CODE	LEAD TIME
Clear	50	DV1	NWD
Buff	50	DV2	NWD
Terracotta	50	DV3	NWD

INSULATION RETAINING DISCS

USE

- To suit most styles and sizes of wall ties and applications
- 80mm and 65mm diameter options

COLOUR	DIAMETER	PACK QTY	PRODUCT CODE	LEAD TIME
Black	65mm	1500	IRD65BL	NWD
Red	80mm	1000	IRD80RD	NWD



TELESCOPIC UNDERFLOOR VENTS



Adjustable telescopic underfloor vent range designed to provide ventilation beneath suspended ground floors of varying coursing heights.

1201



- Adjustable for 3-5 brick courses
- 50-100mm cavity width construction
- Free area of 8,000mm² without airbrick
- Free area of 6,500mm² with airbrick
- Comes with vermin grille

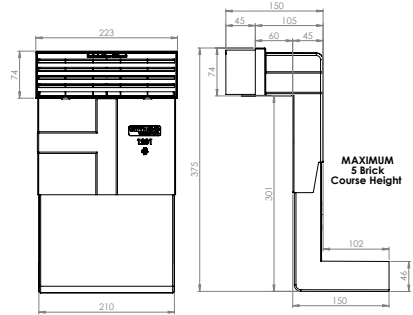

1201XL



- Adjustable for 5-7 brick courses
- 50-150mm cavity width construction
- Free area of 8,000mm² without airbrick
- Free area of 6,500mm² with airbrick
- Comes with vermin grille

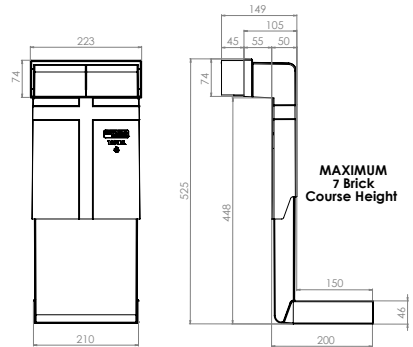

1201XL+



- Adjustable for 5-7 brick courses
- 50-150mm+ cavity width construction
- Free area of 8,000mm² without airbrick
- Free area of 6,500mm² with airbrick

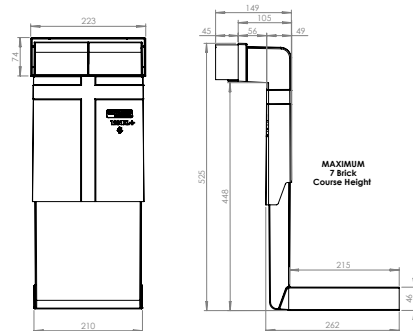

PRODUCT CODE	PACK QTY	HEIGHT	LEAD TIME
1201	20	3-5 Courses	NWD
1201XL	10	5-7 Courses	NWD
1201XLPLUS	10	5-7 Courses	NWD

AND ACCESSORIES

Adapt the **1201**, **1201XL** and **1201XL+** units to suit various applications including horizontal and vertical extensions and ducting adaption, without restricting airflow.

1201ABTE
(Terracotta)

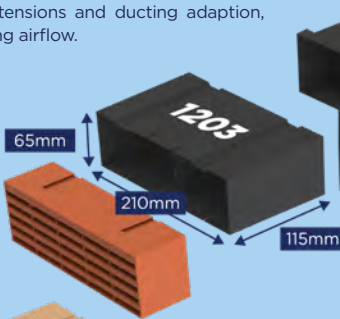

1201ABBU
(Buff)



1201ABGR
(Grey)



1201ABBR
(Brown)



1201ABBL
(Black)



1201ABWH
(White)



1201ABBB
(Blue Black)

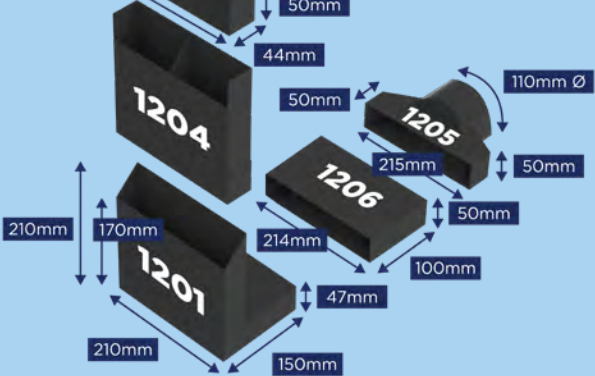
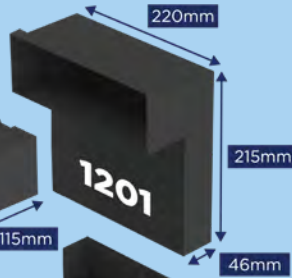
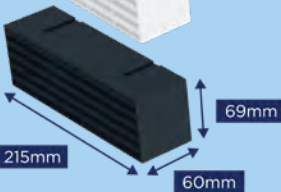

Further details on P.12

TELESCOPIC UNDERFLOOR VENTS

ACCESSORIES

Designed for use with telescopic underfloor vents, these easy-to-fit accessories provide flexible horizontal or vertical extensions to accommodate varying wall, cavity, or brick courses. Multiple units can be combined to achieve greater depths and heights, or used to connect the ventilator directly to a duct.



1203

HORIZONTAL FRONT EXTENSION

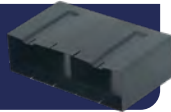

- Provides +115mm horizontal extension
- Fits between airbrick & upper front of vent
- Accommodates external walls more than 102.5mm thickness, up to a maximum of 215mm

1204

VERTICAL EXTENSION



- Provides +150mm vertical extension
- Fits between upper & lower parts of vent
- Multiple units can be added to achieve greater heights

1205

DUCT ADAPTER

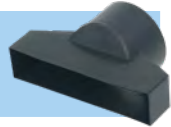

- Enables connection to 110mm Ø plastic drainage pipe
- Fits to lower rear of vent
- To be connected via a coupling connection

1206

HORIZONTAL REAR EXTENSION

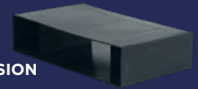

- Provides +100mm horizontal extension
- Fits to lower rear of vent
- Accommodates cavity widths between 50-150mm
- Accommodates internal walls of 100-200mm thickness

PRODUCT CODE	DESCRIPTION	DIMENSIONS	PACK QTY	LEAD TIME
1203	Horizontal Front Extension	65mm (H) x 115mm (W) x 210mm (L)	20	Next Working Day
1204	Vertical Extension	200mm (H) x 44mm (W) x 213mm (L)	20	Next Working Day
1205	Duct Adapter 110mm Ø	50mm (H) x 50mm (W) x 215mm (L)	1	Next Working Day
1206	Horizontal Rear Extension	50mm (H) x 100mm (W) x 214mm (L)	20	Next Working Day

AIRBRICKS

EPD AVAILABLE

COLOUR	PACK QTY	PRODUCT CODE	LEAD TIME
Black	20	1201ABBL	NWD
Blue Black	20	1201ABBB	NWD
Brown	20	1201ABBR	NWD
Buff	20	1201ABBU	NWD
Grey	20	1201ABGR	NWD
Terracotta	20	1201ABTE	NWD
White	20	1201ABWH	NWD

6170mm²
AIRFLOW



USE

- Robust plastic airbrick for use with cavity sleeves and telescopic underfloor vents
- Integral clips enable multiple airbricks to be stacked together

timloc

building products

MANUFACTURING TO THE HIGHEST STANDARDS.

Setting the standard on certification and quality with extensive 3rd party testing and compliance.



THROUGH WALL VENTILATION

EXTERNAL COWLS	15
CAVITY SLEEVES	15
ADAPT-AIR	16
AERO CORE	18
INTERNAL PLASTIC GRILLES	20
INTERNAL METAL GRILLES	20

SCAN TO VIEW
THE RANGE ONLINE



EXTERNAL COWLS

USE

- To provide an external cowl over the airbrick to help reduce draughts caused by wind blasts



PRODUCT CODE	DESCRIPTION	COLOUR	OVERALL DIMENSIONS	EQUIVALENT AREA	PACK QTY	LEAD TIME
ABC93TE	9 x 3 external cowl	Terracotta	255mm x 96mm	8,700mm ²	1	Next Working Day
ABC93BR	9 x 3 external cowl	Brown	255mm x 96mm	8,700mm ²	1	Next Working Day
ABC96TE	9 x 6 external cowl	Terracotta	255mm x 154mm	16,000mm ²	1	Next Working Day
ABC96BR	9 x 6 external cowl	Brown	255mm x 154mm	16,000mm ²	1	Next Working Day
ABC99TE	9 x 9 external cowl	Terracotta	274mm x 235mm	23,900mm ²	1	Next Working Day
ABC99BR	9 x 9 external cowl	Brown	274mm x 235mm	23,900mm ²	1	Next Working Day

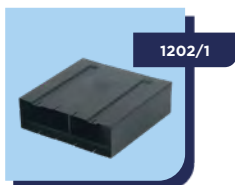

CAVITY SLEEVES

USE

- Cavity sleeves, baffle and extension accessories to provide ventilation through external walls to the building interior

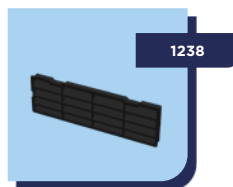
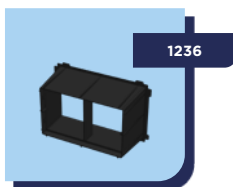
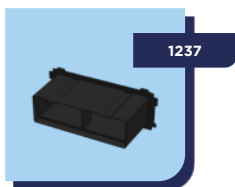

PRODUCT CODE	DESCRIPTION	TO SUIT	PACK QTY	LEAD TIME
1202/1	9 x 3 cavity sleeve	Single airbrick	20	Next Working Day
1202/2	9 x 6 cavity sleeve	2 x stacked airbricks	1	Next Working Day
1237	9 x 3 telescopic extension	+90mm	1	Next Working Day
1236	9 x 6 telescopic extension	+90mm	1	Next Working Day
1238	9 x 3 baffle	Single airbrick	1	Next Working Day



Adapt-Air

Pre-assembled **ducting to airbrick adapter** designed to be built in as part of the brickwork package.



SAVES TIME

build in as part of brickwork package



HELPS TO MEET

Building Regulation Part F



SAFER INSTALLATION

no need for core drilling



COST SAVING

no need for external fitters



CHOICE

of 7 different airbrick colours



PRE-ASSEMBLED

ready to install





Adapt-Air has been designed to be built in as part of the brickwork package and terminates at an external airbrick, removing the need to use unsightly gravity flap vents and avoiding the unsightly re-works of cutting a hole through brickwork.

SINGLE



Single airbrick units in 330mm or 430mm overall lengths.

DOUBLE



Double airbrick units in 330mm or 430mm overall lengths and 125mm or 150mm ducting diameters.

RECTANGULAR



Single airbrick unit with rectangular ducting.

REDUCER



Single airbrick unit with reducer ducting of 110mm diameter.

Use the chart below to establish the Adapt-Air model to suit your specification

	6500	6520	3511	6510	6512	6525	6515	6550
SINGLE OR DOUBLE AIRBRICK	SINGLE	SINGLE	SINGLE	SINGLE	DOUBLE	DOUBLE	DOUBLE	DOUBLE
DUCT SIZE	100MM Ø	100MM Ø	110MM Ø	100MM X54MM	125MM Ø	125MM Ø	150MM Ø	150MM Ø
OVERALL LENGTH	330MM	430MM	450MM	450MM	330MM	430MM	330MM	430MM
DUCTING SHAPE								
SUITED FOR	BATHROOM, WC, UTILITY OR KITCHEN	BATHROOM, WC, UTILITY OR KITCHEN	BATHROOM, WC, UTILITY OR KITCHEN	BATHROOM, WC, UTILITY OR KITCHEN	BATHROOM, WC, UTILITY OR KITCHEN	BATHROOM, WC, UTILITY OR KITCHEN	BATHROOM, WC, UTILITY OR KITCHEN	BATHROOM, WC, UTILITY OR KITCHEN
REDUCER								
SUITED CAVITY SIZE	UP TO 100MM	UP TO 150MM	UP TO 150MM	UP TO 150MM	UP TO 100MM	UP TO 150MM	UP TO 100MM	UP TO 150MM

DESCRIPTION	DUCT SIZE	OVERALL LENGTH	PRODUCT CODE	PACK QTY	LEAD TIME
Adapt-Air Single Airbrick 330mm x 100mm	100mm Ø	330mm	6500 + colour	1	Next Working Day
Adapt-Air Single Airbrick 430mm x 100mm	100mm Ø	430mm	6520 + colour	1	Next Working Day
Adapt-Air Single Airbrick 450mm x 100mm	110mm Ø	450mm	3511 + colour	1	Next Working Day
Adapt-Air Single Airbrick Rectangular 450mm x 100mm x 54mm	100mm x 54mm	450mm	6510 + colour	1	Next Working Day
Adapt-Air Double Airbrick 330mm x 125mm	125mm Ø	330mm	6512 + colour	1	Next Working Day
Adapt-Air Double Airbrick 430mm x 125mm	125mm Ø	430mm	6525 + colour	1	Next Working Day
Adapt-Air Double Airbrick 330mm x 150mm	150mm Ø	330mm	6515 + colour	1	Next Working Day
Adapt-Air Double Airbrick 430mm x 150mm	150mm Ø	430mm	6550 + colour	1	Next Working Day

State required colour at the end of the product code: Terracotta: **TE**, Buff: **BU**, Grey: **GR**, Brown: **BR**, Black: **BL**, White: **WH**

ANTI-DRAUGHT VENTILATORS



Combination ventilator sets for background venting and heat producing appliances. Aesthetically pleasing and simple to install system that is ideal for refurbishment, remedial work, and new build projects.

Available in fixed and adjustable formats and various external colour finishes.

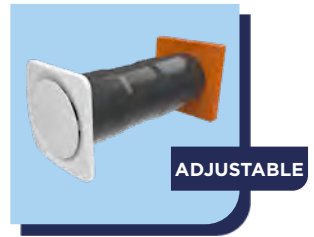
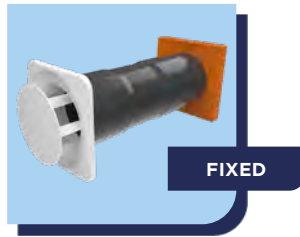
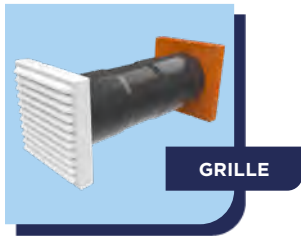

- Equivalent area tested to BS EN 13141-1:2019 by the BRE
- Compliant with BS 5440-2:2023 & BS 5871-3:2005 & BS 493:1995
- Complies with Building Regulation Approved Documents F (2010 edition) & J (2010 edition)

FIXED VENT

DESCRIPTION	EQUIVALENT AREA	APPLIANCE RATED INPUT	EXTERNAL	COLOUR	PACK QTY	PRODUCT CODE	LEAD TIME
5" (127mm) Aero Core Fixed Vent - Baffle	8,000mm ²	23kW (78,500 Btu)	Grille	Terracotta	1	7500TE	NWD
5" (127mm) Aero Core Fixed Vent - Baffle	8,000mm ²	23kW (78,500 Btu)	Grille	Brown	1	7500BR	NWD
5" (127mm) Aero Core Fixed Vent - Baffle	8,000mm ²	23kW (78,500 Btu)	Grille	Buff	1	7500BU	NWD
5" (127mm) Aero Core Fixed Vent - Baffle	8,000mm ²	23kW (78,500 Btu)	Grille	White	1	7500WH	NWD
5" (127mm) Aero Core Fixed Vent - Baffle	8,000mm ²	23kW (78,500 Btu)	Cowl	Terracotta	1	7510TE	NWD
5" (127mm) Aero Core Fixed Vent - Baffle	8,000mm ²	23kW (78,500 Btu)	Cowl	Brown	1	7510BR	NWD
5" (127mm) Aero Core Fixed Vent - Baffle	8,000mm ²	23kW (78,500 Btu)	Cowl	Buff	1	7510BU	NWD
5" (127mm) Aero Core Fixed Vent - Baffle	8,000mm ²	23kW (78,500 Btu)	Cowl	White	1	7510WH	NWD

ADJUSTABLE VENT

DESCRIPTION	EQUIVALENT AREA	APPLIANCE RATED INPUT	EXTERNAL	COLOUR	PACK QTY	PRODUCT CODE	LEAD TIME
5" (127mm) Aero Core Adjustable Vent - Baffle	Up to 8,000mm ²	NA	Grille	Terracotta	1	7520TE	NWD
5" (127mm) Aero Core Adjustable Vent - Baffle	Up to 8,000mm ²	NA	Grille	Brown	1	7520BR	NWD
5" (127mm) Aero Core Adjustable Vent - Baffle	Up to 8,000mm ²	NA	Grille	Buff	1	7520BU	NWD
5" (127mm) Aero Core Adjustable Vent - Baffle	Up to 8,000mm ²	NA	Grille	White	1	7520WH	NWD
5" (127mm) Aero Core Adjustable Vent - Baffle	Up to 8,000mm ²	NA	Cowl	Terracotta	1	7530TE	NWD
5" (127mm) Aero Core Adjustable Vent - Baffle	Up to 8,000mm ²	NA	Cowl	Brown	1	7530BR	NWD
5" (127mm) Aero Core Adjustable Vent - Baffle	Up to 8,000mm ²	NA	Cowl	Buff	1	7530BU	NWD
5" (127mm) Aero Core Adjustable Vent - Baffle	Up to 8,000mm ²	NA	Cowl	White	1	7530WH	NWD

GRILLE VENT

DESCRIPTION	EQUIVALENT AREA	APPLIANCE RATED INPUT	EXTERNAL	COLOUR	PACK QTY	PRODUCT CODE	LEAD TIME
5" (127mm) Aero Core Grille Vent - Baffle	8,000mm ²	23kW (78,500 Btu)	Grille	Terracotta	1	ACV7TE	NWD
5" (127mm) Aero Core Grille Vent - Baffle	8,000mm ²	23kW (78,500 Btu)	Grille	Brown	1	ACV7BR	NWD
5" (127mm) Aero Core Grille Vent - Baffle	8,900mm ²	24.8kW (84,600 Btu)	Cowl	Terracotta	1	ACV7CTE	NWD
5" (127mm) Aero Core Grille Vent - Baffle	8,900mm ²	24.8kW (84,600 Btu)	Cowl	Brown	1	ACV7CBR	NWD

ACCESSORIES

DESCRIPTION	COLOUR	PACK QTY	PRODUCT CODE	LEAD TIME
Aero Core Backplate Accessory	White	1	25159	NWD
Aero Core Tube Accessory	Black	1	ACTUBE	NWD
Aero Core Connector Accessory	White	1	6532	NWD



PERFORMANCE
AT ITS CORE

NEED SOMETHING
EXTRA?

Optional backplate accessory designed to cover chipped areas of internal wall during installation and after core drilling (not compatible with internal grille options).

INTERNAL PLASTIC GRILLES



USE

- To cover the inner opening on the cavity sleeve and provide a neater appearance while still maintaining a free flow of air

PRODUCT CODE	DESCRIPTION	COLOUR	OVERALL DIMENSIONS	EQUIVALENT AREA	PACK QTY	LEAD TIME
1207W	9 x 3 louvre vent	White	260mm x 194mm	7,600mm ²	1	Next Working Day
1211W	9 x 6 louvre vent	White	260mm x 170mm	11,300mm ²	1	Next Working Day
1212W	9 x 9 louvre vent	White	260mm x 235mm	16,500mm ²	1	Next Working Day
1207WF	9 x 3 louvre vent with flyscreen	White	260mm x 104mm	3,750mm ²	1	Next Working Day
1211WF	9 x 6 louvre vent with flyscreen	White	260mm x 170mm	7,150mm ²	1	Next Working Day
1212WF	9 x 9 louvre vent with flyscreen	White	260mm x 235mm	8,190mm ²	1	Next Working Day
1208W	9 x 3 hit & miss louvre vent	White	260mm x 104mm	3,750mm ²	1	Next Working Day
1209W	9 x 6 hit & miss louvre vent	White	260mm x 170mm	7,150mm ²	1	Next Working Day
1210W	9 x 9 hit & miss louvre vent	White	260mm x 235mm	8,190mm ²	1	Next Working Day



INTERNAL METAL GRILLES

USE

- To cover the inner opening on the cavity sleeve and provide a neater appearance while still maintaining a free flow of air



PLAIN ALUMINIUM



BRASS ANODISED



POLISHED BRASS

PRODUCT CODE	DESCRIPTION	COLOUR	OVERALL DIMENSIONS	EQUIVALENT AREA	PACK QTY	LEAD TIME
1220A	9 x 3 hit & miss vent	Plain aluminium	242mm x 89mm	3,741mm ²	1	Next Working Day
1220BA	9 x 3 hit & miss vent	Brass anodised	242mm x 89mm	3,741mm ²	1	Next Working Day
1220PB	9 x 3 hit & miss vent	Polished brass	242mm x 89mm	3,741mm ²	1	Next Working Day
1221A	9 x 6 hit & miss vent	Plain aluminium	242mm x 165mm	6,452mm ²	1	Next Working Day
1221BA	9 x 6 hit & miss vent	Brass anodised	242mm x 165mm	6,452mm ²	1	Next Working Day
1221PB	9 x 6 hit & miss vent	Polished brass	242mm x 165mm	6,452mm ²	1	Next Working Day
1222A	9 x 9 hit & miss vent	Plain aluminium	242mm x 242mm	11,250mm ²	1	Next Working Day
1222BA	9 x 9 hit & miss vent	Brass anodised	242mm x 242mm	11,250mm ²	1	Next Working Day
1222PB	9 x 9 hit & miss vent	Polished brass	242mm x 242mm	11,250mm ²	1	Next Working Day
1223A	9 x 3 louvre vent	Plain aluminium	242mm x 89mm	3,973mm ²	1	Next Working Day
1223BA	9 x 3 louvre vent	Brass anodised	242mm x 89mm	3,973mm ²	1	Next Working Day
1223PB	9 x 3 louvre vent	Polished brass	242mm x 89mm	3,973mm ²	1	Next Working Day
1224A	9 x 6 louvre vent	Plain aluminium	242mm x 165mm	7,946mm ²	1	Next Working Day
1224BA	9 x 6 louvre vent	Brass anodised	242mm x 165mm	7,946mm ²	1	Next Working Day
1224PB	9 x 6 louvre vent	Polished brass	242mm x 165mm	7,946mm ²	1	Next Working Day
1225A	9 x 9 louvre vent	Plain aluminium	242mm x 242mm	12,770mm ²	1	Next Working Day
1225BA	9 x 9 louvre vent	Brass anodised	242mm x 242mm	12,770mm ²	1	Next Working Day
1225PB	9 x 9 louvre vent	Polished brass	242mm x 242mm	12,770mm ²	1	Next Working Day
1226A	25.2 x 2 return air grille	Plain aluminium	648mm x 60mm	9,774mm ²	1	Next Working Day
1226BA	25.2 x 2 return air grille	Brass anodised	648mm x 60mm	9,774mm ²	1	Next Working Day

CAVITY TRAYS

EVERDRY STEPPED - BRICKWORK	24
EVERDRY STEPPED - STONWORK	25
EVERDRY STEPPED - BLOCKWORK	26
EVERDRY STEPPED - BRICKWORK - LEADED	27
EVERDRY STEPPED - STONWORK - LEADED	28
EVERDRY STEPPED - BLOCKWORK - LEADED	29
INTER-LOC HORIZONTAL	30
INTER-LOC HORIZONTAL - LEADED	31
SYSTEM 2000 HORIZONTAL	32
SYSTEM 2000E HORIZONTAL - REFURBISHMENT	33
SYSTEM 2000 HORIZONTAL - LEADED	34
GENERAL PURPOSE TRAYS	35
HORIZONTAL PARAPET TRAYS	36
LINTEL TRAYS	37
THRESHOLD TRAYS	37
DOOR & WINDOW TRAYS	38
PURPOSE MADE TRAYS	38



**SCAN TO VIEW
THE RANGE ONLINE**

CAVITY TRAYS



Use the table below to establish which Timloc cavity tray is best suited to your project specification. If you require any further assistance please contact Technical via the details below: Phone: **01405 782 769** | Email: technical@timloc.co.uk

CAVITY TRAY → APPLICATION ↓	EVERDRY	INTER-LOC	SYSTEM 2000	SYSTEM 2000E	OVER LINTEL	GENERAL PURPOSE	PARAPET HORIZONTAL	PURPOSE MADE	DOOR & WINDOW	LINTEL STOPEND
PITCHED ROOF	✓									
FLAT ROOF		✓	✓	✓						
LEAN-TO		✓	✓	✓						
MONO-PITCH		✓	✓	✓						
CONCRETE RING BEAMS		✓	✓			✓				
AIRBRICKS, DUCTS, LINERS, METER BOXES ETC.		✓	✓	✓		✓				
EXISTING WALLS (REMEDIAL WORK)		✓		✓						
STEEL LINTELS					✓					✓
PARAPET WALLS							✓			
DPC APPLICATIONS								✓		
DOOR & WINDOW ARCHES									✓	
CIRCULAR WINDOWS									✓	
LEADED OPTIONS	✓	✓	✓							

Timloc Building Products offers a wide range of preformed cavity trays to meet almost any application requirement and type of masonry. Here is a brief overview of the cavity trays available:

EVERDRY STEPPED

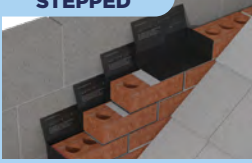

Stepped cavity tray system with variable bed thickness options for brick, block and stone work. Available leaded and unleaded.

INTER-LOC HORIZONTAL



Pre-formed horizontal cavity tray system for new build and existing walls. Leaded and unleaded options available.

SYSTEM 2000 HORIZONTAL



Horizontal cavity tray system suitable for new build brick/block/stone work constructions.

SYSTEM 2000E HORIZONTAL



Horizontal cavity trays suitable for remedial work on existing brick, block or stone work.

LINTEL TRAYS



For installation directly above modern steel lintels in external cavity walls.

THRESHOLD TRAYS

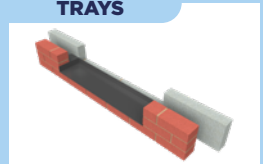

Preformed DPC threshold protection trays to suit standard openings.

GENERAL PURPOSE



For installation in various applications such as above floor beams, roof abutments and meter boxes.

HORIZONTAL PARAPET



For installation directly into the internal wall of parapet wall applications.

PURPOSE MADE



Special made-to-measure damp proof course units for DPC applications.

DOOR & WINDOW



Made-to-measure for all types of door and window arches and circular windows.

PLOT-SPECIFIC DELIVERY

Plot delivery is available for leaded, unleaded and polystrip cavity trays. There will be a 25% surcharge for unleaded and polystrip tray plot deliveries.

Please specify on your order if you require this service.

EVERDRY STEPPED CAVITY TRAYS **BRICKWORK**



USE

- At the abutment of a pitched roof with a cavity wall
- On external walls - not exceeding 120mm thickness - built from standard brickwork or similar sized components with regular course heights, including mortar of approx. 75mm
- On roof pitches of 10° and above



PRODUCTS IN THE RANGE

Intermediate trays: Forms main tray run with one tray on each course of brickwork running the full length of the abutting roof slope.

Stopend starters: Suits all roof pitches - first component to be installed and fitted at the lowest point on a standard abutment. Collects water gathered by the rest of the system and discharges it from the wall through a weep hole.

Corner starter trays: Suits all roof pitches - has same function as stopend starter tray but is used where the abutting roof comes up to, or beyond, the corner of the main building. Designed to return around the corner of the building to provide complete protection.

Ridge trays: Suits all roof pitches - used where a right hand and left hand roof slope come together at an apex to straddle the top two intermediate trays.



**Intermediate tray
(LH)**



**Stopend starter tray
(LH/RH)**

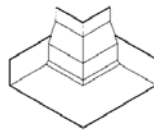

**Corner starter tray
(LH/RH)**



Ridge tray

Free call off and scheduling service available. Contact Technical for further assistance via the details below:

Phone: **01405 782 769** | Email: **technical@timloc.co.uk**

EVERDRY STEPPED CAVITY TRAYS **STONEMWORK**

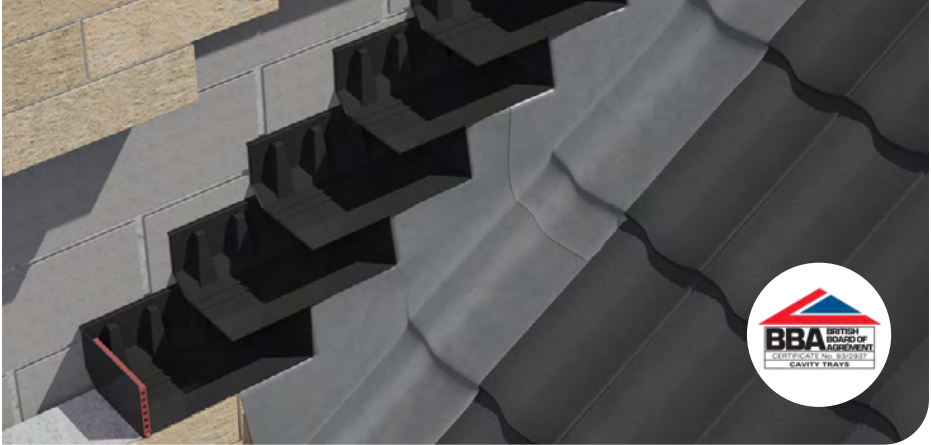

USE

- At the abutment of a pitched roof with a cavity wall
- On external walls - not exceeding 150mm thickness - built from natural or reconstituted stone with regular course heights, including mortar of approx. 150mm
- On roof pitches of 7.5° and above
- Contact Timloc Technical for larger cavity widths



PRODUCTS IN THE RANGE

Intermediate trays: Forms main tray run with one tray on each course of stonework running the full length of the abutting roof slope.

Stopend starters: Suits all roof pitches - first component to be installed and fitted at the lowest point on a standard abutment. Collects water gathered by the rest of the system and discharges it from the wall through a weep hole.

Corner starter trays: Suits all roof pitches - has same function as stopend starter tray but is used where the abutting roof comes up to, or beyond, the corner of the main building. Designed to return around the corner of the building to provide complete protection.

Ridge trays: Suits all roof pitches. Used where a right hand and left hand roof slope come together at an apex to straddle the top two intermediate trays.

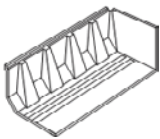

Intermediate tray
(LH)



Stopend starter tray
(LH/RH)

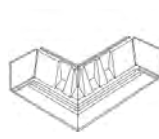

Corner starter tray
(RH)

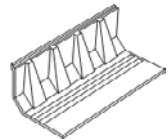

Ridge tray

Free call off and scheduling service available. Contact Technical for further assistance via the details below:

Phone: **01405 782 769** | Email: **technical@timloc.co.uk**

EVERDRY STEPPED CAVITY TRAYS **BLOCKWORK**

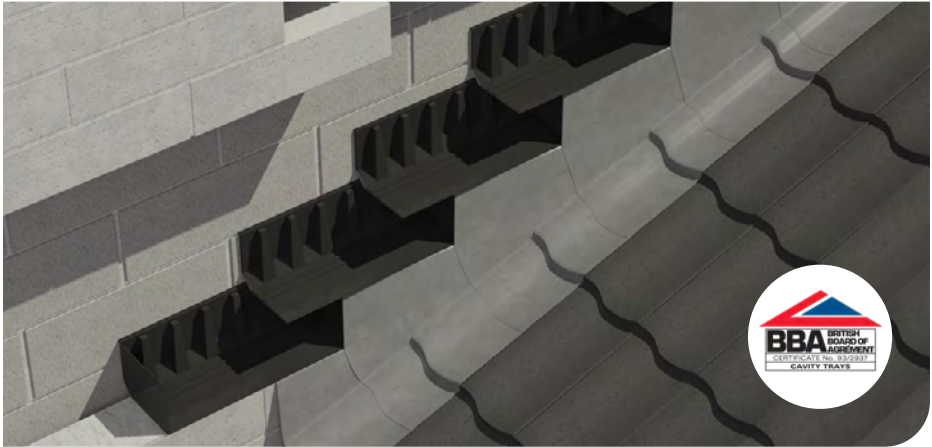

USE

- At the abutment of a pitched roof with a cavity wall
- On external walls - not exceeding 150mm thickness - built from blockwork or stone with regular course heights, including mortar of approx. 225mm
- On roof pitches of 12.5° and above
- Contact Timloc Technical for larger cavity widths



PRODUCTS IN THE RANGE

Intermediate trays: Forms main tray run with one tray on each course of blockwork/stonework running the full length of the abutting roof slope.

Stopend starters: Suits all roof pitches - first component to be installed and fitted at the lowest point on a standard abutment. Collects water gathered by the rest of the system and discharges it from the wall through a weep hole.

Corner starter trays: Suits all roof pitches - has same function as stopend starter tray but is used where the abutting roof comes up to, or beyond, the corner of the main building. Designed to return around the corner of the building to provide complete protection.

Ridge trays: Suits all roof pitches - used where a right hand and left hand roof slope come together at an apex to straddle the top two intermediate trays.

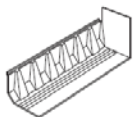

Intermediate tray
(LH)

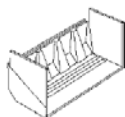

Stopend starter tray
(LH/RH)

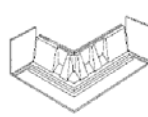

Corner starter tray
(RH)

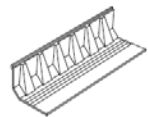

Ridge tray

Free call off and scheduling service available. Contact Technical for further assistance via the details below:

Phone: **01405 782 769** | Email: **technical@timloc.co.uk**

EVERDRY STEPPED CAVITY TRAYS **BRICKWORK** LEADED

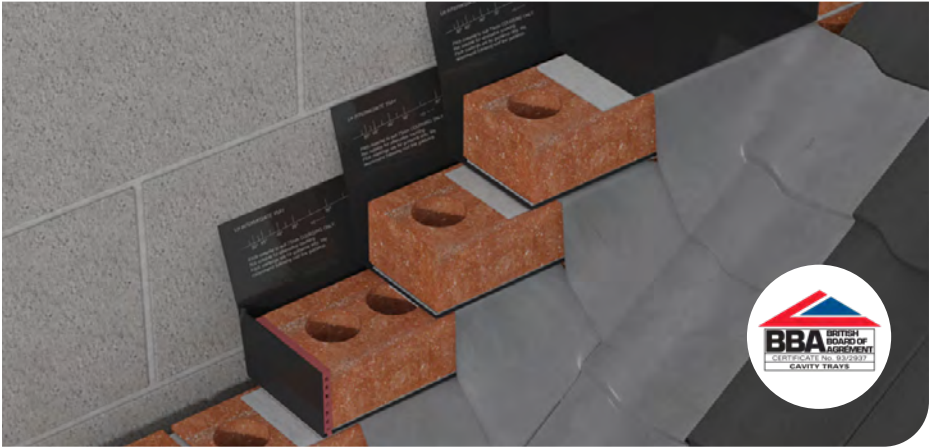

USE

- At the abutment of a pitched roof with a cavity wall
- On external walls - not exceeding 120mm thickness - built from standard brickwork or similar sized components with regular course heights, including mortar of approx. 75mm
- On roof pitches of 10° and above



PRODUCTS IN THE RANGE

Intermediate trays: Forms main tray run with one tray on each course of brickwork running the full length of the abutting roof slope.

Stopend starters: Suits all roof pitches - first component to be installed and fitted at the lowest point on a standard abutment. Collects water gathered by the rest of the system and discharges it from the wall through a weep hole.

Corner starter trays: Suits all roof pitches - has same function as stopend starter tray but is used where the abutting roof comes up to, or beyond, the corner of the main building. Designed to return around the corner of the building to provide complete protection.

Ridge trays: Suits all roof pitches - used where a right hand and left hand roof slope come together at an apex to straddle the top two intermediate trays.



Intermediate tray (LH)
Short Lead



Intermediate tray (LH)
Long Lead



Stopend starter tray (LH)
Short Lead

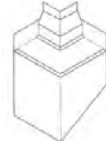

Corner starter tray (LH)
Long Lead



Ridge tray

Free call off and scheduling service available. Contact Technical for further assistance via the details below:
Phone: **01405 782 769** | Email: technical@timloc.co.uk

EVERDRY STEPPED CAVITY TRAYS **STONERWORK** LEADED

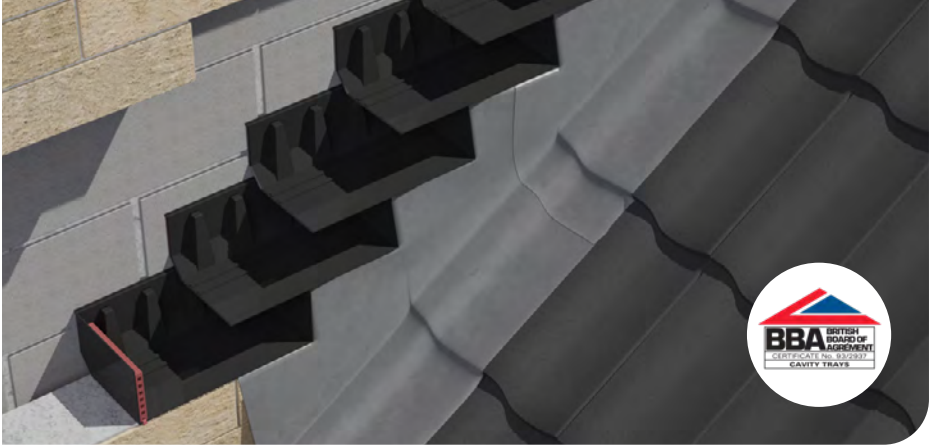

USE

- At the abutment of a pitched roof with a cavity wall
- On external walls - not exceeding 150mm thickness - built from natural or reconstituted stone with regular course heights, including mortar of approx. 150mm
- On roof pitches of 15° and above



PRODUCTS IN THE RANGE

Intermediate trays: Forms main tray run with one tray on each course of stonework running the full length of the abutting roof slope.

Stopend starters: Suits all roof pitches - first component to be installed and fitted at the lowest point on a standard abutment. Collects water gathered by the rest of the system and discharges it from the wall through a weep hole.

Corner starter trays: Suits all roof pitches. Same function as stopend starter tray but is used where the abutting roof comes up to, or beyond, the corner of the main building. Designed to return around the corner of the building for complete protection. Corner starter trays are not supplied with factory fitted lead flashings due to the size and weight of lead flashing required. Flashing in this area should be dealt with separately in the traditional way.

Ridge trays: Suits all roof pitches. Used where a right hand and left hand roof slope come together at an apex to straddle the top two intermediate trays.



**Intermediate tray
(LH)
Long Lead**



**Stopend
starter tray (LH)
Long Lead**



Ridge tray

EVERDRY STEPPED CAVITY TRAYS **BLOCKWORK** LEADED

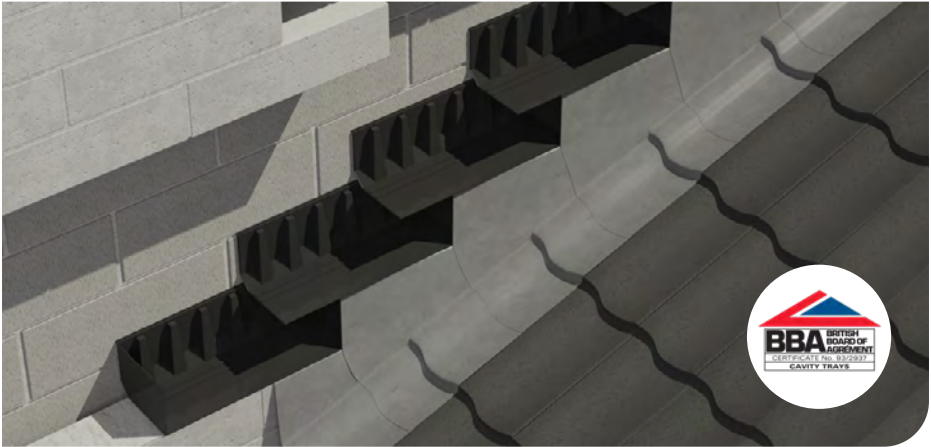

USE

- At the abutment of a pitched roof with a cavity wall
- On external walls - not exceeding 150mm thickness - built from blockwork or stone with regular course heights, including mortar of approx. 225mm
- On roof pitches of 12.5° and above



PRODUCTS IN THE RANGE

Intermediate trays: Forms main tray run with one tray on each course of blockwork/stonework running the full length of the abutting roof slope.

Stopend starters: Suits all roof pitches - first component to be installed and fitted at the lowest point on a standard abutment. Collects water gathered by the rest of the system and discharges it from the wall through a weep hole.

Corner starter trays: Suits all roof pitches. Same function as stopend starter tray but is used where the abutting roof comes up to, or beyond, the corner of the main building. Designed to return around the corner of the building for complete protection. Corner starter trays are not supplied with factory fitted lead flashings due to the size and weight of lead flashing required. Flashing in this area should be dealt with separately in the traditional way.

Ridge trays: Suits all roof pitches. Used where a right hand and left hand roof slope come together at an apex to straddle the top two intermediate trays.



**Intermediate tray
(LH)
Long Lead**



**Stopend
starter tray (LH)
Long Lead**

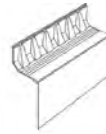

Ridge tray

INTER-LOC HORIZONTAL CAVITY TRAYS

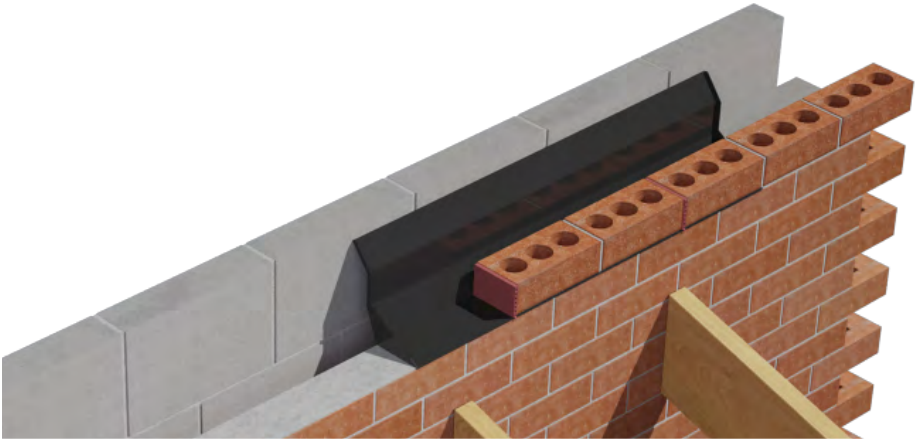

USE

- At the abutment of a flat roof with a cavity wall
- At the abutment of a lean-to or mono pitch roof with a cavity wall
- Over concrete ring beams
- Over airbricks, cavity liners, ducts, meter boxes, etc.
- On external walls - not exceeding 102.5mm in thickness - built from standard brick, block or stone
- Clear cavity widths of between 50-125mm



PRODUCTS IN THE RANGE

Horizontal Inter-loc cavity trays: The main cavity tray component sections join together by means of a lapped interlocking joint, to form the main cavity tray run. Water is gathered by the cavity tray and is discharged from the wall through a series of weep holes - one weep hole per Inter-loc tray is required.

Corner Units: Allows the integrity of the main cavity tray run to be maintained when it is necessary to turn a corner on a building. Available in either external or internal format.

Stopends: Fitted at the start and finish of the cavity tray run to seal off the open ends and prevent water running back into the cavity.



Existing build
horizontal tray
IL2/E



New build
horizontal tray
IL4



New build
external corner
EXT90

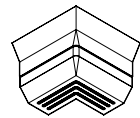

New build
internal corner
INT90

Free call off and scheduling service available. Contact Technical for further assistance via the details below:

Phone: **01405 782 769** | Email: **technical@timloc.co.uk**

INTER-LOC HORIZONTAL CAVITY TRAYS **LEADED**

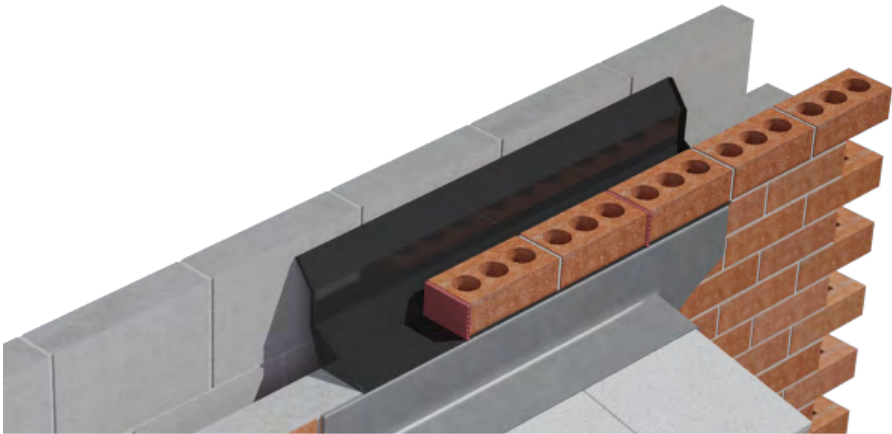

USE

- At the abutment of a flat roof with a cavity wall
- At the abutment of a lean-to or mono pitch roof with a cavity wall
- On external walls - not exceeding 102.5mm in thickness - built from standard brick, block or stone
- Clear cavity widths of between 50-125mm



PRODUCTS IN THE RANGE

Horizontal Inter-loc cavity trays: The main cavity tray component sections join together by means of a lapped interlocking joint, to form the main cavity tray run. Water is gathered by the cavity tray and is discharged from the wall through a series of weep holes - one weep hole per Inter-loc tray is required.

Corner Units: Allows the integrity of the main cavity tray run to be maintained when it is necessary to turn a corner on a building. Available in either external or internal format.

Stopends: Fitted at the start and finish of the cavity tray run to seal off the open ends and prevent water running back into the cavity.

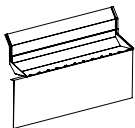

4 brick
300mm drop lead
IL4

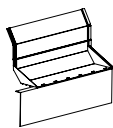

2 brick tray
150mm drop lead
IL2

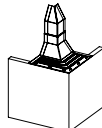

External corner
300mm drop lead
EXT90

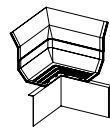

Internal corner
150mm drop lead
INT90

Free call off and scheduling service available. Contact Technical for further assistance via the details below:

Phone: **01405 782 769** | Email: **technical@timloc.co.uk**

SYSTEM 2000 HORIZONTAL CAVITY TRAYS



USE

- At the abutment of a flat roof with a cavity wall
- At the abutment of a lean-to or mono pitch roof with a cavity wall
- Over concrete ring beams
- Over airbricks, cavity liners, ducts, meter boxes, etc.
- Clear cavity widths of between 50-150mm



PRODUCTS IN THE RANGE

Horizontal cavity trays: The main cavity tray component sections join together by means of a lapped joint, sealed with factory applied butyl masking tape, to form the main cavity tray run. Water is gathered by the cavity tray and is discharged from the wall through a series of weep holes.

Corner Units: Allows the integrity of the main cavity tray run to be maintained when it is necessary to turn a corner on a building. Available in either external or internal format.

Stopends: Fitted at the start and finish of the cavity tray run to seal off the open ends and prevent water running back into the cavity.

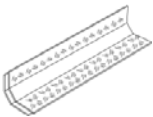

Horizontal tray

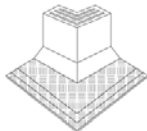

External corner

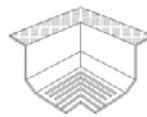

Internal corner

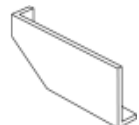

Stopend (LH)

Free call off and scheduling service available. Contact Technical for further assistance via the details below:

Phone: **01405 782 769** | Email: **technical@timloc.co.uk**

SYSTEM 2000E HORIZONTAL CAVITY TRAYS

REFURBISHMENT



USE

- For remedial work where a horizontal cavity tray must be inserted into an existing wall
- At the abutment of a flat roof with a cavity wall
- At the abutment of a lean-to or mono pitch roof with a cavity wall
- Over airbricks, cavity liners, ducts, meter boxes, etc.
- On external walls - not exceeding 102.5mm in thickness - built from standard brick, block or stone
- Clear cavity widths of between 50-125mm



PRODUCTS IN THE RANGE

Horizontal cavity trays: The main cavity tray component. Sections join together by means of a lapped joint, sealed with factory applied butyl mastic tape, to form the main cavity tray run. Water is gathered by the cavity tray and is discharged from the wall through a series of weep holes.

Corner Units: Allows the integrity of the main cavity tray run to be maintained when it is necessary to turn a corner on a building. Available in either external or internal format.

Stopends: Fitted at the start and finish of the cavity tray run to seal off the open ends and prevent water running back into the cavity.



E-Horizontal tray



External corner



Internal corner



Stopend (LH)

Free call off and scheduling service available. Contact Technical for further assistance via the details below:
Phone: 01405 782 769 | Email: technical@timloc.co.uk

SYSTEM 2000 HORIZONTAL CAVITY TRAYS

LEADED

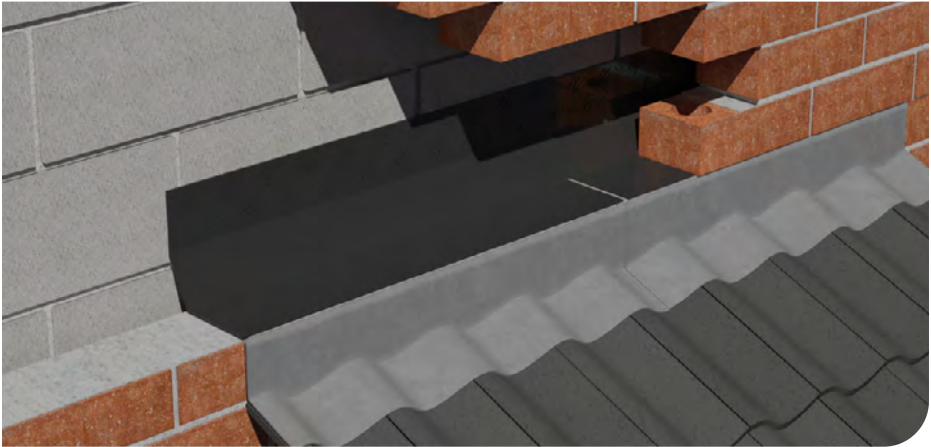

USE

- At the abutment of a lean-to, flat or mono pitch roof and cavity wall
- On external walls - not exceeding 102.5mm in thickness - built from standard brickwork, blockwork or stone
- Clear cavity widths of between 50-125mm



PRODUCTS IN THE RANGE

Horizontal cavity trays: The main cavity tray component. Sections join together by means of a lapped joint, sealed with factory applied butyl mastic tape, to form the main cavity tray run. Water is gathered by the cavity tray and is discharged from the wall through a series of weep holes.

Corner Units: Allows the integrity of the main cavity tray run to be maintained when it is necessary to turn a corner on a building. Available in either external or internal format.

Stopends: Fitted at the start and finish of the cavity tray run to seal off the open ends and prevent water running back into the cavity.



Horizontal tray

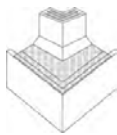

External corner



Internal corner



Stopend (LH)

Free call off and scheduling service available. Contact Technical for further assistance via the details below:
Phone: **01405 782 769** | Email: **technical@timloc.co.uk**

GENERAL PURPOSE TRAYS



USE

- For installation in various applications
- Above floor beams
- Roof abutments
- Meter boxes



PRODUCTS IN THE RANGE

Horizontal cavity trays: The main cavity tray component. Sections can be joined together by means of a sealing tape, such as Timloc's GTAPE01 (available separately) to form the main cavity tray run. Water is gathered by the cavity tray and is discharged from the wall through a series of weep holes.

Corner Units: Allows the integrity of the main cavity tray run to be maintained when it is necessary to turn a corner on a building. Available in either external or internal format.

Stopends: Fitted at the start and finish of the cavity tray run to seal off the open ends and prevent water running back into the cavity.

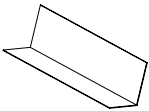

Horizontal tray

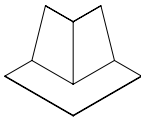

External corner

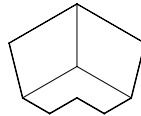

Internal corner

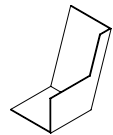

Stopend

HORIZONTAL PARAPET TRAYS

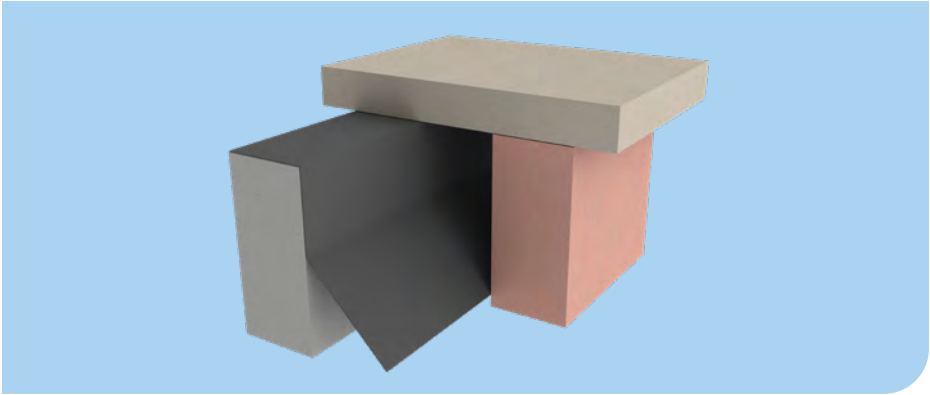

USE

- For installation directly into the internal wall of parapet wall applications



PRODUCTS IN THE RANGE

Horizontal parapet trays: The main cavity tray component. Sections can be joined together by means of a sealing tape, such as Timloc's GTAPE01 (available separately) to form the main cavity tray run. Water is gathered by the cavity tray and is discharged from the wall through a series of weep holes.

Corner Units: Allows the integrity of the main cavity tray run to be maintained when it is necessary to turn a corner on a building. Available in either external or internal format.

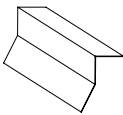

Horizontal
tray

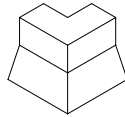

External
corner

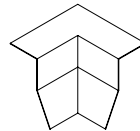

Internal
corner

Free call off and scheduling service available. Contact Technical for further assistance via the details below:

Phone: **01405 782 769** | Email: **technical@timloc.co.uk**

LINTEL TRAYS



USE

- On steel lintels situated in external walls
- On external walls - not exceeding 102.5mm in thickness - built in standard brick, block or stone

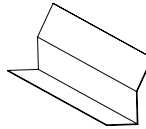

Lintel tray

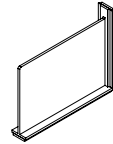

Lintel stopend

PRODUCTS IN THE RANGE

Lintel trays: The main cavity tray component to be built over window and door openings. Allow 150mm overbearing either side, to be trimmed or joined when longer than 2500mm openings. Water is gathered by the cavity tray and is discharged from the wall through a series of weep holes.

Stopends: Fitted at the start and finish of the cavity tray run to seal off the open ends and prevent water running back into the cavity.

THRESHOLD TRAYS

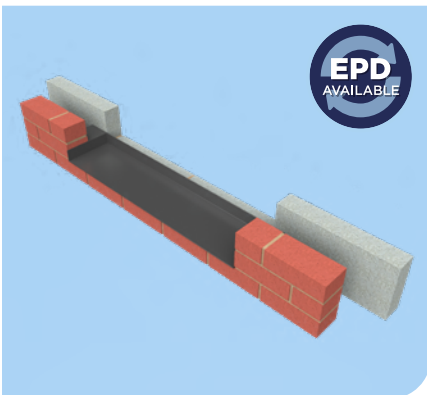

USE

- Preformed DPC threshold protection trays to suit standard openings



Threshold tray

PRODUCTS IN THE RANGE

Threshold protection trays: Pre-shaped, waterproof barrier fitted at low-level door openings to stop moisture from entering the building. It channels any water within the cavity safely outward and keeps the junction between inside and outside materials, like flooring, insulation and damp-proof layers protected. By providing reliable damp control at door thresholds, it supports compliance with building regulations for level access installations.

DOOR & WINDOW TRAYS



USE

- Around the opening of an external door or window with an arched top or a circular external window
- On external walls - built from brick, block or stone as well as timber frame constructions - of any thickness and any cavity width

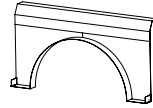

Arched door

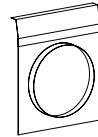

Circular window

HOW TO ORDER

Arch cavity trays are made to order, so please supply full construction details. Ideally these will include a fully dimensioned drawing showing door/window opening size and wall construction details. If this is not possible the minimum information required is:

- Thickness of outer leaf and cavity width
- Clear opening width and height of door/window opening
- Radius of curvature
- Position of spring line

With this data Timloc will be able to produce and despatch a dimensioned drawing for your approval.

PURPOSE MADE TRAYS



USE

- Made-to-measure trays for wherever DPC is used to form a horizontal cavity tray
- To substitute the cutting, moulding and sealing of a DPC when forming cavity trays, angles, stop ends etc.

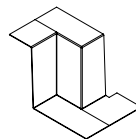

Door closer cloak (RH/LH)

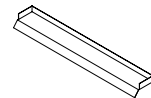

Threshold tray

PRODUCTS IN THE RANGE

- Cavity trays for brick support systems
- Parapet cavity tray systems
- Pier, column and corner cloaks
- Threshold trays
- Change of level units
- Radius units
- Stop end and junction cappings
- Ring beam cavity tray systems

HOW TO ORDER

These products are made to order, so please supply full construction details, ideally including fully dimensioned drawings.

CAVITY TRAYS

WHY TRUST TIMLOC WITH THE FULL PACKAGE?

Free **product specification** & scheduling

House **plot-specific** delivery available

Various ranges to suit an assortment of abutments

Leaded & unleaded options - long & short lead available

Next day delivery on all standard products

Installation & legislation guidance available

TOP HATS, DPC & GAS BARRIERS

TOP HAT	41
FLEXIBLE TOP HATS	41
1201 TOP HAT	41
DAMP PROOF COURSING	42
RADON SUMP	43
ACCESSORIES	43



SCAN TO VIEW
THE RANGE ONLINE

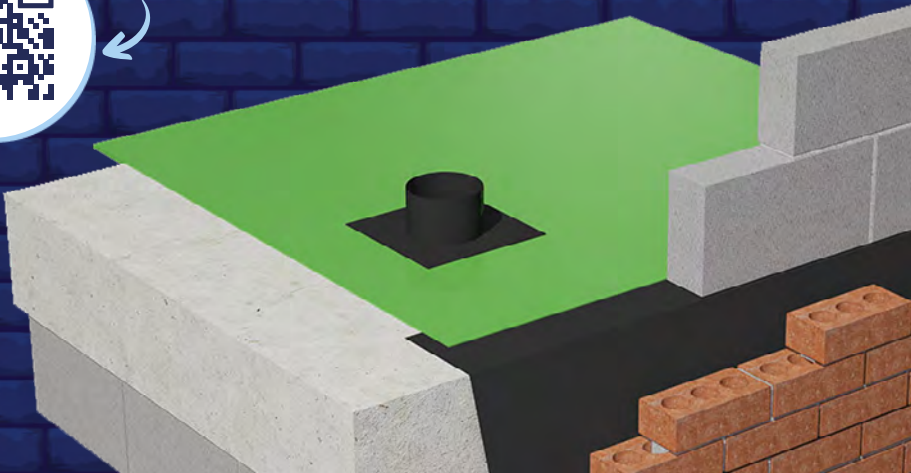

TOP HATS



USE

- In areas outlined in BRE document 'Radon' guidance on protective measures in new dwellings
- When gas protection is required across the building footprint
- Suitable for Radon, Hydrocarbon, Methane and CO₂

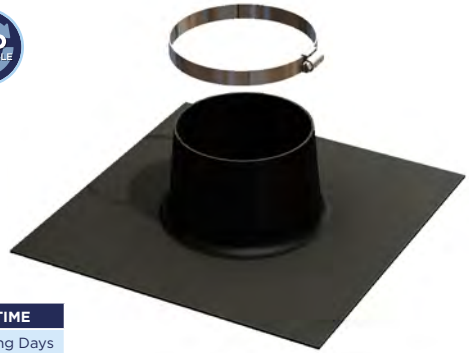

COLLAR SIZE	PACK QTY	PRODUCT CODE	LEAD TIME
55mm	1	TH055	3-5 Working Days
82mm	1	TH082	3-5 Working Days
110mm	1	TH110	Next Working Day
135mm	1	TH135	Next Working Day
160mm	1	TH160	Next Working Day

FLEXIBLE TOP HATS

USE

- In areas outlined in BRE document 'Radon' guidance on protective measures in new dwellings
- When gas protection is required across the building footprint
- Suitable for Radon, Hydrocarbon, Methane and CO₂

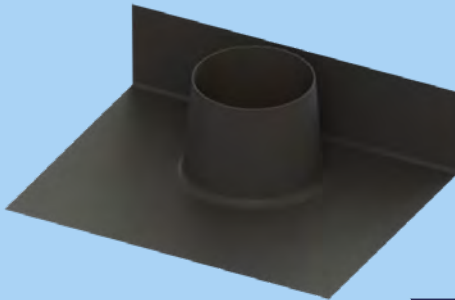

COLLAR SIZE	PACK QTY	PRODUCT CODE	LEAD TIME
110mm	1	77110	Next Working Day
135mm	1	77135	Next Working Day

1201 TOP HATS

USE

- For sealing 1201 range of telescopic underfloor vents
- When gas protection is required
- Suitable for Radon, Hydrocarbon, Methane and CO₂

COLLAR SIZE	PACK QTY	PRODUCT CODE	LEAD TIME
214 x 46mm	1	77120	Next Working Day



DAMP PROOF COURSING

Preformed accessories to complete damp proof coursing (DPC) and horizontal cavity tray systems at vulnerable areas, such as corners and changes of level, to ensure protection from water ingress. **All DPC is available on a 3-5 working day turnaround.**

STOP ENDS

DESCRIPTION	HANDING	BUILT IN AT 150MM RISE			BUILT IN AT 225MM RISE		
		PRODUCT CODES TO SUIT CLEAR CAVITY WIDTHS OF:					
		50MM	75MM	100MM	50MM	75MM	100MM
Stop End - Full Height	RH	9010	9012	9014	9018	9020	9022
Stop End - Full Height	LH	9011	9013	9015	9019	9021	9023
Stop End - 75mm Height (Sloping)	RH	9045	9047	9049	9051	9053	9055
Stop End - 75mm Height (Sloping)	LH	9046	9048	9050	9052	9054	9056
Stop End - 75mm Height	Multi	9024	9024	9024	9024	9024	9024

CHANGE OF LEVEL

DESCRIPTION	HANDING	BUILT IN AT 150MM RISE			BUILT IN AT 225MM RISE		
		PRODUCT CODES TO SUIT CLEAR CAVITY WIDTHS OF:					
		50MM	75MM	100MM	50MM	75MM	100MM
Change of Level - 75mm Step	Multi	9060	9063	9066	9070	9073	9076
Change of Level - 150mm Step	Multi	9061	9064	9067	9071	9074	9067
Change of Level - 225mm Step	Multi	9062	9065	9068	9072	9075	9078

JOINT SUPPORT

DESCRIPTION	BUILT IN AT 150MM RISE			BUILT IN AT 225MM RISE		
	PRODUCT CODES TO SUIT CLEAR CAVITY WIDTHS OF:					
	50MM	75MM	100MM	50MM	75MM	100MM
Joint Support	9026	9027	9028	9030	9031	9032

DESCRIPTION	BUILT IN AT 150MM RISE			BUILT IN AT 225MM RISE		
	PRODUCT CODES TO SUIT CLEAR CAVITY WIDTHS OF:					
	50MM	75MM	100MM	50MM	75MM	100MM
Corner Unit	9001	9002	9003	9004	9005	9006

CORNER UNIT

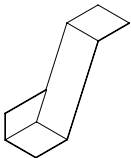

Stop ends

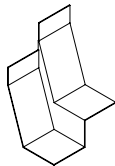

Change of level

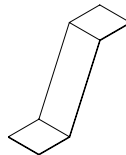

Joint support

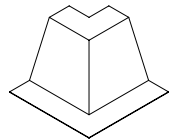

Corner unit

RADON SUMP

USE

- Where sub floor depressurisation is required under full radon protection
- Beneath the floor slab in non-suspended floor applications and vented via a 110mm drainage pipe to an external source and capped off with proprietary products i.e. airbrick, telescopic underfloor vent or roof vent

PACK QTY	PRODUCT CODE	LEAD TIME
1	RSUMP01	Next Working Day



GASTITE SEALING TAPE



GIRTH TAPE

JUBILEE CLIPS



**SIZE 5
FOR TH055**



**SIZE 6
FOR TH082 & TH110**



**SIZE 7
FOR TH135 & TH160**

ACCESSORIES

USE

- GTAPE01 is to be used to make the seal between joint surfaces
- GTAPE02 is used to seal upper surface to minimise lap lifting if used in concrete floors

DESCRIPTION	PACK QTY	PRODUCT CODE	LEAD TIME
Jubilee Clip 5	1	JCLIP5	Next Working Day
Jubilee Clip 6	1	JCLIP6	Next Working Day
Jubilee Clip 7	1	JCLIP7	Next Working Day
Gastite Sealing Tape	1	GTAPE01	Next Working Day
Girth Tape	1	GTAPE02	Next Working Day

CAVITY CLOSERS & STOP SOCKS

Fire-rated cavity closers & stop socks | Non-fire-rated cavity closers

THERMO-LOC MULTI CAVITY CLOSER	46
THERMO-LOC + CAVITY CLOSER	47
THERMO-LOC + FX CAVITY CLOSER	48
FR30 30-MINUTE FIRE RATED CAVITY CLOSER	49
FR60 60-MINUTE FIRE RATED CAVITY CLOSER	50
FR60+ 60-MINUTE FIRE RATED CAVITY CLOSER	50
FRSTOP CAVITY STOP SOCK MASONRY-MASONRY	52
TIMFRSTOP CAVITY STOP SOCK TIMBER-MASONRY	53
TTFRSTOP CAVITY STOP SOCK TIMBER-TIMBER	54
PWFRSTOP PARTY WALL CAVITY STOP SOCK MASONRY-MASONRY	55
PWTIMFRSTOP PARTY WALL CAVITY STOP SOCK TIMBER-MASONRY	56



SCAN TO VIEW
THE RANGE ONLINE

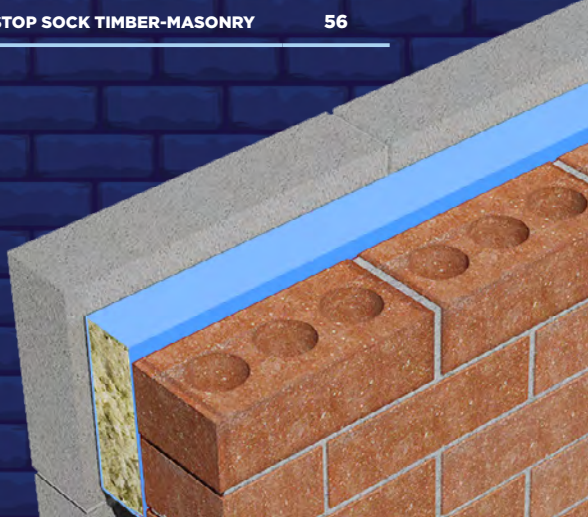

CAVITY CLOSERS & STOP SOCKS

Cavity closers and stop socks are fundamental elements of any cavity wall to help reduce condensation, cold bridging and mould growth. The range offers thermal, acoustic and fire protection depending on your requirements.

The Thermo-loc range is designed to lock warmth inside a building; offering greater protection against the risk of condensation, at a lower material thickness, when compared to standard cavity closers.

THERMO-LOC

Use the table below to help establish the cavity closer that suits your specification. Cavity stop sock table available on P.51.

	THERMO-LOC MULTI	THERMO-LOC +	THERMO-LOC + FX	THERMO-LOC FR30	THERMO-LOC FR60	THERMO-LOC FR60+
PRODUCT CODE	CC2.4PPS/..	PP2.4/..	FX2.4/..	CC2.4FR/..	FR60/..	FR60/..
SHAPE	T	C	C FX	C FX	C FX	C FX
FIRE RATED	✗	✗	✗	✓	✓	✓
CHECK REVEAL	✗	✓	✓	✓	✓	✗
PROFILE	50 - 100 SINGLE 100 - 150 SINGLE	50 - 100 SINGLE 105 - 150 DOUBLE	50 - 100 SINGLE 105 - 150 DOUBLE	50 - 100 SINGLE 105 - 300 DOUBLE	50 - 100 SINGLE 105 - 150 SINGLE	150 - 300 SINGLE
LENGTH	2.4M	2.4M	2.4M	2.4M	2.4M	2.4M
THICKNESS	20MM	25MM	25MM	25MM	30MM	50MM
MULTI OPTION	✓ UP TO 150MM	✓ UP TO 100MM	✓ UP TO 100MM	✗	✗	✗
BUILDING REG. PARTS C&L COMPLIANT	✓	✓	✓	✓	✓	✓
BUILDING REG. PART B COMPLIANT	✗	✗	✗	✓	✓	✓



TECHNICAL SUPPORT

Full product information is available on the Timloc website. If you require any further assistance please contact Technical via the details below:

Phone: **01405 782 769** | Email: technical@timloc.co.uk

Scan the QR code to view full product datasheets.

BUILD WITH CONFIDENCE USING BBA-APPROVED CLOSERS

Ensuring the quality and reliability of building materials is critical for safety, efficiency, and long-term durability in construction projects. A product where such assurance is vital is cavity closers.

That's why **BBA certification matters.**



Scan the QR code to read more.

Fire-rated and non fire-rated cavity closers designed to eliminate damp and cold bridging around doors, windows, and sills. Cavity closers available to suit a variety of applications on pages 46-50.

THERMO-LOC

MULTI CAVITY CLOSER

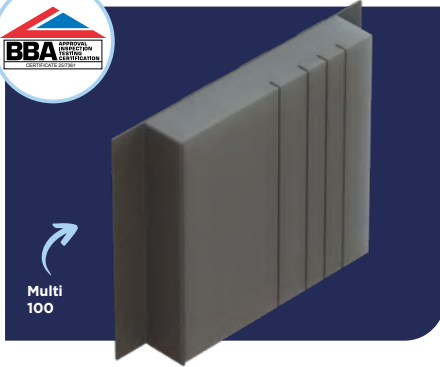

Multi 100

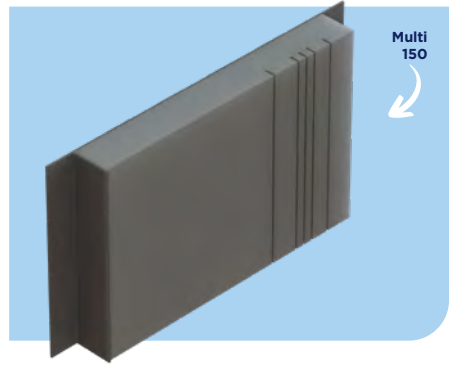

Multi 150

USE

- To close cavity at external doors, window jambs and sills
- To provide thermal insulation and prevent 'cold bridging'
- To provide DPC at external doors, window jambs or sills
- Suitable for cavities up to 150mm

Single Profile 50 - 100mm



Single Profile 100 - 150mm



Suitable for a range of cavity sizes up to 150mm by easily cutting to size using the pre-cut grooves. 20mm insulation thickness. Compliant with Building Regulation Approved Documents C, L1 and L2 and satisfies BRE document 'Thermal Insulation: avoiding risks'.

Product Code	Description	Cavity Width	Length	Pack Qty
CC2.4PPS/MULTI100	Thermo-loc Multi 50-100mm	50-100mm	2.4m	10
CC2.4PPS/MULTI150	Thermo-loc Multi 100-150mm	100-150mm	2.4m	10

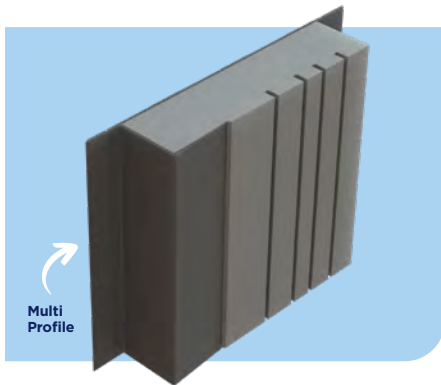
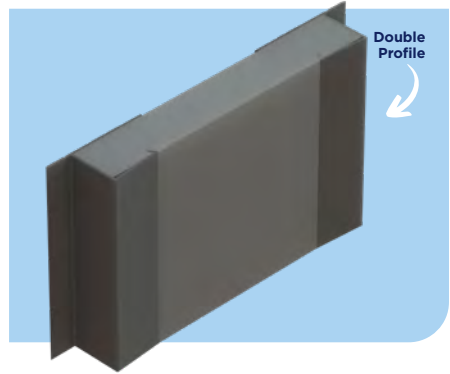
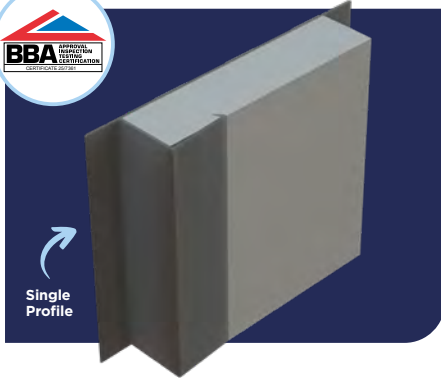

USE

- To close cavity at external doors, window jambs and sills
- To provide thermal insulation and prevent 'cold bridging'
- To provide DPC at external doors, window jambs or sills
- Suitable for cavities up to 150mm

Single Profile
50 - 100mm



Double Profile
105 - 150mm



Multi Check Reveal
Single Flange



Single profile for 50mm-100mm cavities, double profile for 105mm-150mm cavities, Multi and Check Reveal Multi options also available. 25mm insulation thickness. Compliant with Building Regulation Approved Documents C, L1 and L2 and satisfies BRE document 'Thermal Insulation: avoiding risks'.

PRODUCT CODE	DESCRIPTION	CAVITY WIDTH	LENGTH	PACK QTY
PP2.4/50	Thermo-loc +	50mm	2.4m	10
PP2.4/75	Thermo-loc +	75mm	2.4m	10
PP2.4/90	Thermo-loc +	90mm	2.4m	10
PP2.4/100	Thermo-loc +	100mm	2.4m	10
PP2.4/100MULTI	Thermo-loc + Multi	50-100mm	2.4m	10
PP2.4/120	Thermo-loc +	120mm	2.4m	10
PP2.4/125	Thermo-loc +	125mm	2.4m	10
PP2.4/130	Thermo-loc +	130mm	2.4m	10
PP2.4/150	Thermo-loc +	150mm	2.4m	10
PP2.4/CR100MULTI	Thermo-loc + CR Multi	50-100mm	2.4m	10

THERMO-LOC

+ FX CAVITY CLOSER

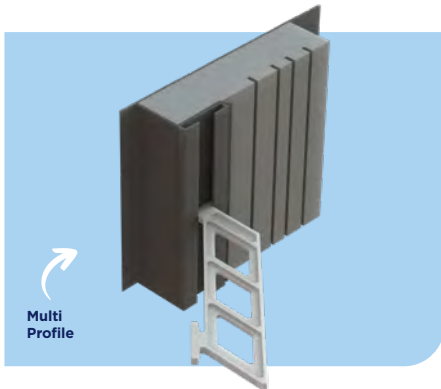
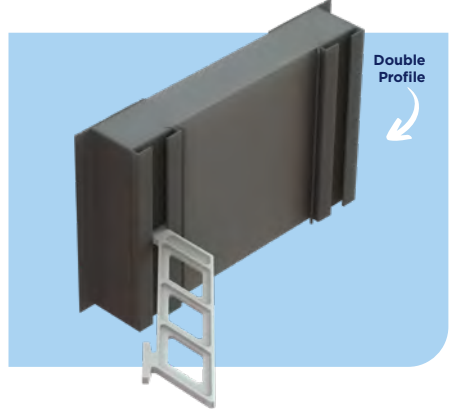
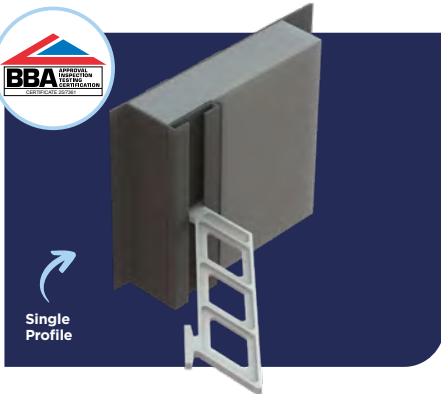

USE

- To close cavity at external doors, window jambs and sills
- To provide thermal insulation and prevent 'cold bridging'
- To provide DPC at external doors, window jambs or sills
- Suitable for cavities up to 150mm

Single Profile
50 - 100mm



Double Profile
105 - 150mm



Multi Check Reveal
Single Flange



Single profile for 50mm-100mm cavities, double profile for 105mm-150mm cavities, Multi and Check Reveal options also available. 25mm insulation thickness. Compliant with Building Regulation Approved Documents C, L1 and L2 and satisfies BRE document 'Thermal Insulation: avoiding risks'.

PRODUCT CODE	DESCRIPTION	CAVITY WIDTH	LENGTH	PACK QTY
FX2.4/50	Thermo-loc + FX	50mm	2.4m	10
FX2.4/75	Thermo-loc + FX	75mm	2.4m	10
FX2.4/90	Thermo-loc + FX	90mm	2.4m	10
FX2.4/100	Thermo-loc + FX	100mm	2.4m	10
FX2.4/120	Thermo-loc + FX	120mm	2.4m	10
FX2.4/125	Thermo-loc + FX	125mm	2.4m	10
FX2.4/130	Thermo-loc + FX	130mm	2.4m	10
FX2.4/150	Thermo-loc + FX	150mm	2.4m	10
FX2.4/100MULTI	Thermo-loc + Multi FX	50-100mm	2.4m	10
FX2.4/CR50	Thermo-loc + FX CR	50mm	2.4m	10
FX2.4/CR100	Thermo-loc + FX CR	100mm	2.4m	10
FX2.4/CR125	Thermo-loc + FX CR	125mm	2.4m	10
FX2.4/CR150	Thermo-loc + FX CR	150mm	2.4m	10
FX2.4/CR100MULTI	Thermo-loc + CR Multi	50-100mm	2.4m	10
CCFIX	Fixing Ties	NA	NA	100

THERMO-LOC FIRE-RATED CAVITY CLOSERS

BUILD WITH CONFIDENCE USING BBA-APPROVED CLOSERS

Ensuring the quality and reliability of building materials is critical for safety, efficiency, and long-term durability in construction projects. A product where such assurance is vital is cavity closers.

That's why **BBA certification matters.**



Scan the QR code to read more.

Timloc Building Products offers a range of fire-rated cavity closers, each independently tested and certified by Warringtonfire in accordance with EN1366-4 principles.

Full product datasheets and test certificates are available from the Timloc website at: timloc.co.uk.

Scan the QR code to view the test certificates.



3rd party tested by Warringtonfire in accordance with EN1366-4 principles

FR30

30-MINUTE FIRE-RATED CAVITY CLOSER

USE

- To close the cavity at external doors, window jambs and sills
- To provide thermal insulation and prevent 'cold bridging'
- To provide a DPC at external doors, window jambs or sills
- 30 minutes fire rating and minimum 15 minutes insulation
- Suitable for cavities up to 300mm
- Suitable for masonry walls only

FEATURES

- Single profile for 50-100mm cavities
- Double profile for 105-300mm cavities
- Supplied in 2.4m lengths
- 25mm insulation thickness
- Fully rebated and check reveal options available
- Building Reg. Approved Documents C, B, L1 and L2 compliant
- Satisfies BRE document 'Thermal Insulation: avoiding risks'

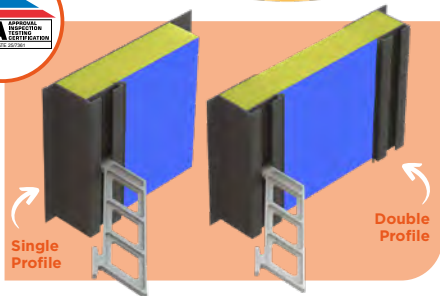

Single Profile

Double Profile

PRODUCT CODE	CAVITY WIDTH	PACK QTY
CC2.4FR/50	50mm	10
CC2.4FR/65	65mm	10
CC2.4FR/75	75mm	10
CC2.4FR/90	90mm	10
CC2.4FR/100	100mm	5
CC2.4FR/125	125mm	5
CC2.4FR/150	150mm	3

NB. Non standard cavity sizes up to 300mm are available to special order.



FR60

60-MINUTE FIRE-RATED CAVITY CLOSER

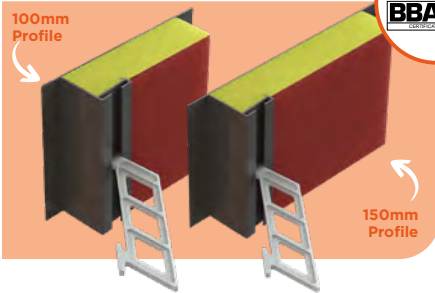

PRODUCT CODE	CR	CAVITY WIDTH	PACK QTY
FR60/50	No	50mm	5
FR60/100	No	100mm	5
FR60/125	No	125mm	5
FR60/150	No	150mm	5
FR60/CR50	Yes	50mm	5
FR60/CR100	Yes	100mm	5
FR60/CR125	Yes	125mm	5
FR60/CR150	Yes	150mm	5

USE

- To close the cavity at external doors, window jambs and sills
- To provide thermal insulation and prevent 'cold bridging'
- To provide a DPC at external doors, window jambs or sills
- 60 minutes fire rating and minimum 15 minutes insulation
- Suitable for cavities up to 150mm
- Suitable for masonry walls only

FEATURES

- Single profile for 50-100mm cavities and 105-150mm cavities
- Supplied in 2.4m lengths
- 30mm insulation thickness
- Fully rebated and check reveal options available
- Building Reg. Approved Documents C, B, L1 and L2 compliant
- Satisfies BRE document 'Thermal Insulation: avoiding risks'

FR60+

60-MINUTE FIRE-RATED CAVITY CLOSER

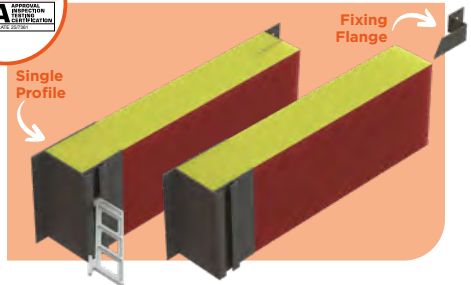

USE

- To close the cavity at external doors, window jambs and sills
- To provide thermal insulation and prevent 'cold bridging'
- To provide a DPC at external doors, window jambs or sills
- 60 minutes fire rating and minimum 15 minutes insulation
- Suitable for cavities over 150mm up to 300mm
- Suitable for masonry walls only

FEATURES

- Single profile for 151-300mm cavities
- 50mm insulation thickness
- Supplied with 4 metal fixing flanges to be slotted in place
- Supplied in 2.4m lengths
- Fully rebated option only
- Building Reg. Approved Documents C, B, L1 and L2 compliant
- Satisfies BRE document 'Thermal Insulation: avoiding risks'

PRODUCT CODE	CAVITY WIDTH	PACK QTY
FR60/175	175mm	2
FR60/200	200mm	2
FR60/225	225mm	2
FR60/250	250mm	2
FR60/275	275mm	2
FR60/300	300mm	2

NEED SOMETHING EXTRA?

PRODUCT CODE	DESCRIPTION	PACK QTY
3322*	Fixing flanges	4
CCFIX	Fixing ties	100

*1 pack of fixing flanges supplied per length of Thermo-loc FR60 + cavity closer profile.

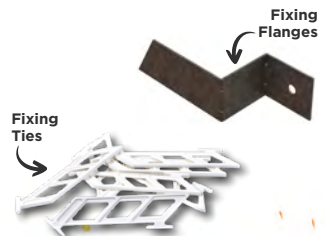

FRSTOP

CAVITY STOP SOCKS

60-minute fire-rated cavity stop socks available from Timloc Building Products suitable for a wide range of constructions and applications, including timber frame, masonry and party walls. Independently 3rd party tested and certified for 60-minute fire-rating. Available to suit various cavity widths up to either 150mm or 300mm where applicable.



60-MINUTE
FIRE-RATED



3RD PARTY
TESTED



WEATHER
PROTECTION



1200MM
LENGTHS



APPROVED
DOCUMENT B



ROBUST
DETAIL E



BS EN 13162
COMPLIANT



MINIMISES
NOISE

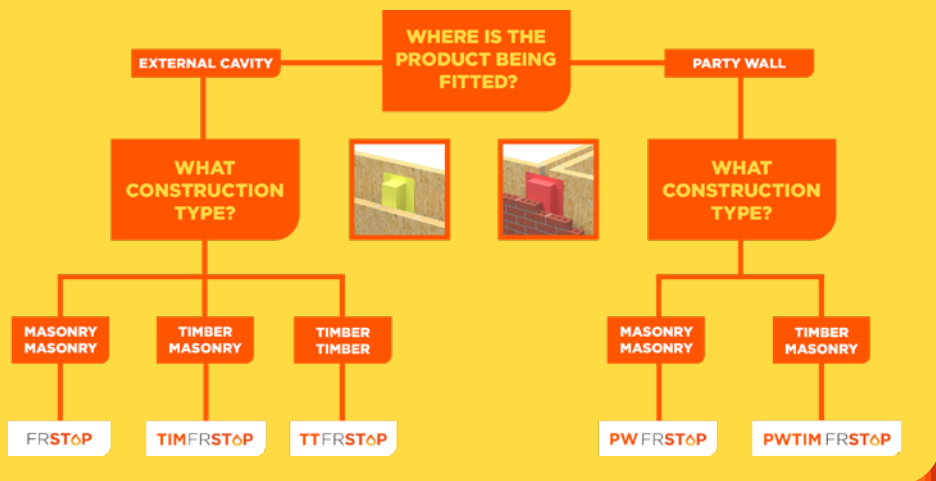

DESIGNED TO PROTECT

All fire-rated closers and stop socks are 3rd party tested by Warringtonfire in accordance with EN1366-4 principles.

Scan the QR code to view test certificates.



FRSTOP

60-MINUTE FIRE-RATED CAVITY STOP SOCK FOR MASONRY-MASONRY



3rd party tested
by Warringtonfire
in accordance with
EN1366-4
principles

USE

- To restrict the spread of flames within external masonry-masonry cavity walls
- To further minimise the effect of flanking noise pollution at wall junctions
- To provide a cavity barrier at separating walls, separating floors and around window and door apertures



- FRSTOP cavity stop socks comprise a length of non-combustible mineral wool insulation sleeved in a polythene outer layer for on-site weather protection
- 60 minute fire integrity and minimum 15 minutes insulation
- Available to suit cavity widths from 50mm up to 300mm
- Supplied in 1.2m lengths

PRODUCT CODE	TO SUIT CAVITY WIDTH	DIMENSIONS	MIN. COMPRESSION	BAG COLOUR	PACK QUANTITY
FRSTOP50	50mm	65 x 65 x 1200mm	15mm	Yellow	20
FRSTOP75	66-75mm	85 x 85 x 1200mm	10mm	Blue	18
FRSTOP85	76-85mm	100 x 85 x 1200mm	15mm	Blue	12
FRSTOP90	86-90mm	100 x 85 x 1200mm	10mm	Blue	12
FRSTOP100	91-100mm	110 x 100 x 1200mm	10mm	Blue	1
FRSTOP115	101-115mm	130 x 2100 x 1200mm	15mm	Green	1
FRSTOP125	116-125mm	140 x 100 x 1200mm	15mm	Green	1
FRSTOP150	141-150mm	160 x 100 x 1200mm	10mm	Red	1

NB. Non standard cavity sizes up to 300mm are available to special order. Bag colour may vary.

TIMFRSTOP

60-MINUTE FIRE-RATED CAVITY STOP SOCK FOR TIMBER-MASONRY

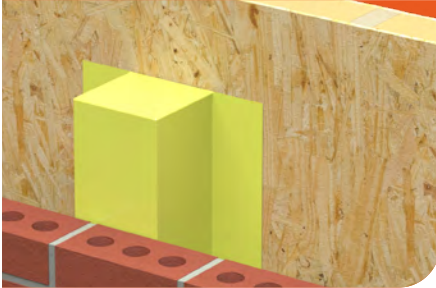

3rd party tested
by Warringtonfire
in accordance with
EN1366-4
principles



USE

- To restrict the spread of smoke and flames within external timber-masonry cavity walls
- To provide a cavity barrier at separating walls, separating floors and around window or door apertures
- To minimise heat loss and effect of flanking noise pollution through the cavity wall

- TIMFRSTOP cavity stop socks comprise a length of non-combustible mineral wool insulation sleeved in a polythene outer layer for on-site weather protection
- 60 minute fire integrity and insulation performance
- Available to suit cavity widths from 50mm up to 150mm
- Supplied in 1.2m lengths

PRODUCT CODE	TO SUIT CAVITY WIDTH	DIMENSIONS	MIN. COMPRESSION	BAG COLOUR	PACK QUANTITY	PALLET QUANTITY
TIMFRSTOP50	50mm	65 x 65 x 1200mm	15mm	Red	20	240
TIMFRSTOP65	51-65mm	85 x 75 x 1200mm	20mm	Red	18	216
TIMFRSTOP75	66-75mm	100 x 75 x 1200mm	25mm	Red	12	144
TIMFRSTOP85	76-85mm	100 x 150 x 1200mm	15mm	Yellow	NA	102
TIMFRSTOP90	86-90mm	110 x 150 x 1200mm	20mm	Yellow	NA	90
TIMFRSTOP100	91-100mm	120 x 150 x 1200mm	20mm	Yellow	NA	90
TIMFRSTOP115	101-115mm	130 x 150 x 1200mm	15mm	Yellow	NA	72
TIMFRSTOP125	116-125mm	140 x 150 x 1200mm	15mm	Yellow	NA	72
TIMFRSTOP130	126-130mm	150 x 150 x 1200mm	20mm	Yellow	NA	66
TIMFRSTOP140	131-140mm	160 x 150 x 1200mm	20mm	Yellow	NA	60
TIMFRSTOP150	141-150mm	160 x 150 x 1200mm	10mm	Yellow	NA	60

NB. Pallet quantities may vary slightly from the values stated above. Contact sales@timloc.co.uk for confirmation. Bag colour may vary.

TTFRSTOP

60-MINUTE FIRE-RATED CAVITY STOP SOCK FOR TIMBER-TIMBER

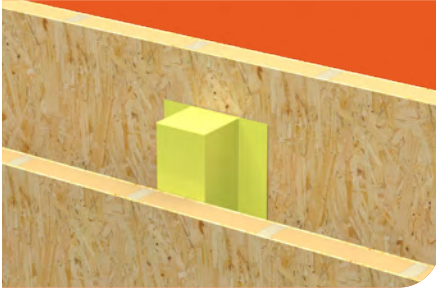

3rd party tested
by Warringtonfire
in accordance with
EN1366-4
principles

USE

- To restrict the spread of smoke and flames within external timber-timber cavity walls
- To provide a cavity barrier at separating walls, separating floors and around window or door apertures
- To minimise heat loss and effect of flanking noise pollution through the cavity wall



- TTFRSTOP cavity stop socks comprise a length of non-combustible mineral wool insulation sleeved in a polythene outer layer for on-site weather protection
- 60 minute fire integrity and insulation performance
- Available to suit cavity widths from 50mm up to 150mm
- Supplied in 1.2m lengths

PRODUCT CODE	TO SUIT CAVITY WIDTH	DIMENSIONS	MIN. COMPRESSION	BAG COLOUR	PALLET QUANTITY
TTFRSTOP50	50mm	85 x 150 x 1200mm	35mm	Yellow	90
TTFRSTOP65	51-65mm	100 x 150 x 1200mm	35mm	Yellow	102
TTFRSTOP75	66-75mm	110 x 150 x 1200mm	35mm	Yellow	90
TTFRSTOP85	76-85mm	120 x 150 x 1200mm	35mm	Yellow	84
TTFRSTOP90	86-90mm	120 x 150 x 1200mm	30mm	Yellow	84
TTFRSTOP100	91-100mm	130 x 150 x 1200mm	30mm	Yellow	78
TTFRSTOP115	101-115mm	150 x 150 x 1200mm	35mm	Yellow	66
TTFRSTOP125	116-125mm	160 x 150 x 1200mm	35mm	Yellow	60
TTFRSTOP130	126-130mm	160 x 150 x 1200mm	30mm	Yellow	60
TTFRSTOP140	131-140mm	175 x 150 x 1200mm	35mm	Yellow	54
TTFRSTOP150	141-150mm	185 x 150 x 1200mm	35mm	Yellow	54

NB. Pallet quantities may vary slightly from the values stated above. Contact sales@timloc.co.uk for confirmation. Bag colour may vary.

PWFRSTOP

60-MINUTE FIRE-RATED PARTY WALL CAVITY STOP SOCK FOR MASONRY-MASONRY

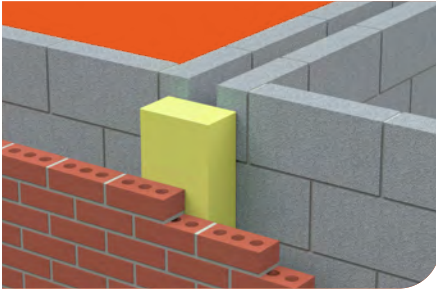

3rd party tested
by Warringtonfire
in accordance with
EN1366-4
principles

USE

- To restrict the spread of smoke and flames within external masonry-masonry cavity walls
- To provide a cavity barrier at party wall junctions
- To minimise heat loss and effect of flanking noise pollution through the cavity wall



- PWFRSTOP cavity stop socks comprise a length of non-combustible mineral wool insulation sleeved in a polythene outer layer for on-site weather protection
- 60 minute fire integrity and insulation performance
- Available to suit cavity widths from 50mm up to 300mm
- Supplied in 1.2m lengths

PRODUCT CODE	TO SUIT CAVITY WIDTH	DIMENSIONS	MIN. COMPRESSION	BAG COLOUR	PALLET QUANTITY
PWFRSTOP50	50mm	65 x 250 x 1200mm	15mm	Yellow	100
PWFRSTOP65	51-65mm	85 x 250 x 1200mm	20mm	Blue	60
PWFRSTOP75	66-75mm	85 x 250 x 1200mm	10mm	Blue	75
PWFRSTOP85	76-85mm	100 x 250 x 1200mm	15mm	Blue	68
PWFRSTOP90	86-90mm	100 x 250 x 1200mm	10mm	Blue	68
PWFRSTOP100	91-100mm	110 x 250 x 1200mm	10mm	Blue	60
PWFRSTOP115	101-115mm	130 x 250 x 1200mm	15mm	Yellow	52
PWFRSTOP125	116-125mm	140 x 250 x 1200mm	15mm	Yellow	48
PWFRSTOP130	126-130mm	150 x 250 x 1200mm	20mm	Yellow	48
PWFRSTOP140	131-140mm	160 x 250 x 1200mm	20mm	Yellow	44
PWFRSTOP150	141-150mm	160 x 250 x 1200mm	10mm	Red	40
PWFRSTOP160	151-160mm	185 x 250 x 1200mm	25mm	Red	36
PWFRSTOP170	161-170mm	195 x 250 x 1200mm	25mm	Red	32
PWFRSTOP180	171-180mm	200 x 250 x 1200mm	20mm	Red	32
PWFRSTOP190	181-190mm	210 x 250 x 1200mm	20mm	Red	32
PWFRSTOP200	191-200mm	220 x 250 x 1200mm	20mm	Red	28
PWFRSTOP210	201-210mm	230 x 250 x 1200mm	20mm	Blue	28
PWFRSTOP220	211-220mm	240 x 250 x 1200mm	20mm	Blue	28
PWFRSTOP230	221-230mm	250 x 250 x 1200mm	20mm	Blue	24
PWFRSTOP240	231-240mm	260 x 250 x 1200mm	20mm	Blue	24
PWFRSTOP250	241-250mm	270 x 250 x 1200mm	20mm	Blue	24
PWFRSTOP260	251-260mm	280 x 250 x 1200mm	20mm	Blue	24
PWFRSTOP270	261-270mm	290 x 250 x 1200mm	20mm	Blue	24
PWFRSTOP280	271-280mm	300 x 250 x 1200mm	20mm	Blue	20
PWFRSTOP290	281-290mm	310 x 250 x 1200mm	20mm	Blue	20
PWFRSTOP300	291-300mm	320 x 250 x 1200mm	20mm	Blue	20

NB. Pallet quantities may vary slightly from the values stated above. Contact sales@timloc.co.uk for confirmation. Bag colour may vary.

PWTIMFRSTOP

60-MINUTE FIRE-RATED PARTY WALL CAVITY STOP SOCK FOR TIMBER-MASONRY

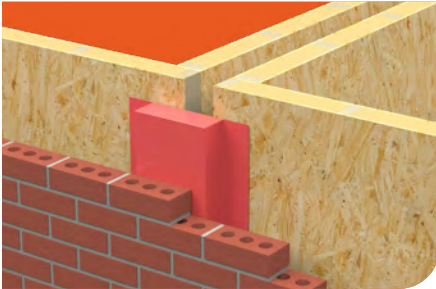

3rd party tested
by Warringtonfire
in accordance with
EN1366-4
principles

USE

- To restrict the spread of smoke and flames within external timber-masonry cavity walls
- To provide a cavity barrier at party wall junctions
- To minimise heat loss and effect of flanking noise pollution through the cavity wall



- PWTIMFRSTOP cavity stop socks comprise a length of non-combustible mineral wool insulation sleeved in a polythene outer layer for on-site weather protection
- 60 minute fire integrity and insulation performance
- Available to suit cavity widths from 50mm up to 150mm
- Supplied in 1.2m lengths

PRODUCT CODE	TO SUIT CAVITY WIDTH	DIMENSIONS	MIN. COMPRESSION	BAG COLOUR	PALLET QUANTITY
PWTIMFRSTOP50	50mm	65 x 250 x 1200mm	15mm	Red	80
PWTIMFRSTOP65	51-65mm	85 x 250 x 1200mm	20mm	Red	60
PWTIMFRSTOP75	66-75mm	85 x 250 x 1200mm	10mm	Red	60
PWTIMFRSTOP85	76-85mm	100 x 250 x 1200mm	15mm	Red	68
PWTIMFRSTOP90	86-90mm	100 x 250 x 1200mm	10mm	Red	68
PWTIMFRSTOP100	91-100mm	110 x 250 x 1200mm	10mm	Red	60
PWTIMFRSTOP115	101-115mm	130 x 250 x 1200mm	15mm	Red	52
PWTIMFRSTOP125	116-125mm	140 x 250 x 1200mm	15mm	Red	48
PWTIMFRSTOP130	126-130mm	140 x 250 x 1200mm	10mm	Red	48
PWTIMFRSTOP140	131-140mm	150 x 250 x 1200mm	10mm	Red	44
PWTIMFRSTOP150	141-150mm	160 x 250 x 1200mm	10mm	Red	40

NB. Pallet quantities may vary slightly from the values stated above. Contact sales@timloc.co.uk for confirmation. Bag colour may vary.



ACCESS PRODUCTS

Plastic, metal and fire rated loft doors and access panels

LOFTITE HINGED DROP DOWN LOFT DOOR 58

PUSH-UP PLASTIC LOFT DOOR 60

PLASTIC HINGED DROP DOWN LOFT DOOR 60

Z-SERIES 1 HOUR FIRE-RATED METAL LOFT DOOR 61

LOFT-LOC LOFT DOOR POLES 61

PLASTIC ACCESS PANELS 62

AIRTIGHT PLASTIC ACCESS PANELS 62

Z-SERIES METAL ACCESS PANELS 63

METAL 1 HOUR FIRE-RATED ACCESS PANELS 63

SCAN TO VIEW
THE RANGE ONLINE



OPEN UP TO THE FUTURE



SCAN TO VIEW
THE RANGE ONLINE



3x U-VALUE OPTIONS
AVAILABLE:

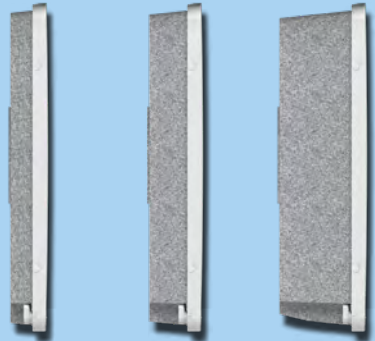

0.35 W/m²K 0.25 W/m²K 0.15 W/m²K

Pre-assembled **hinged drop down loft access door** designed to be easy to install and for convenient through-ceiling access to loft spaces.



**EXCEEDS BUILDING
REGULATIONS PART L1
& L2 FOR AIRTIGHTNESS**



**TWO SEPARATE AIR
SEALS FOR MAXIMIZING
AIRTIGHTNESS**



**KEY LOCK OPTION
ALSO AVAILABLE**



**FITTING SLOTS FOR AN
EASY, SINGLE PERSON
INSTALLATION**



**AVAILABLE ON OUR
FREE NEXT DAY
DELIVERY**

**PATENT
PENDING
EASY FIT SLOT**

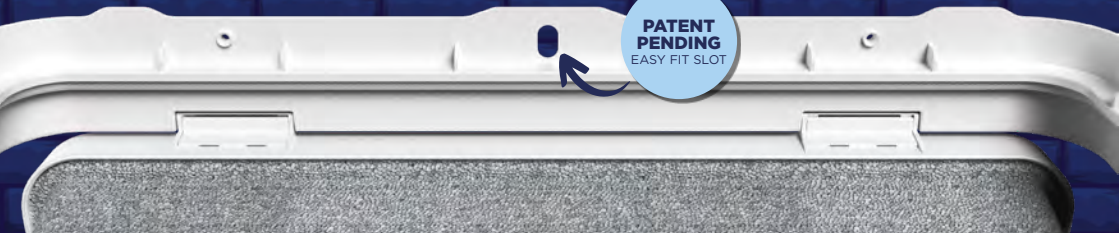

LOFT DOORS

Timloc loft doors are designed to be easy-to-install and provide easy through-ceiling access into the loft space, as well as insulation and draft proofing around the opening in a ceiling.



Loftite arrives pre-assembled and ready to fit, featuring a precision-engineered frame with an insulated door mounted on stainless steel hinge pins. Dual air seals ensure exceptional airtightness, while twin catches provide a secure and reliable fit.

Designed for easy, single-person installation, Loftite includes fitting slots, neat hinge caps, and requires no maintenance or painting. It offers a maximised open access area to allow easy and unobstructed entry to the loft space and is fully compatible with most loft ladders.

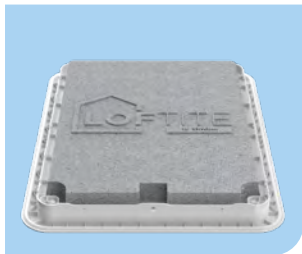

LT0035

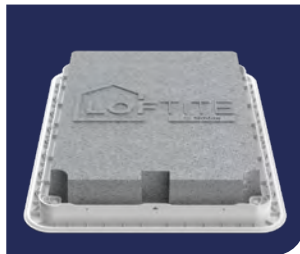

LT0025

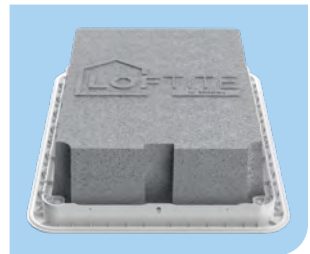

LT0015

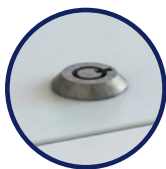

KEY LOCK OPTION
ALSO AVAILABLE



- As standard the U-0.35 insulation option helps to meet the requirements of the Robust Construction Detail.
- The U-0.25 and U-0.15 options help to achieve the higher performance levels required by the Code for Sustainable Homes and the Future Homes Standard.
- Meets and exceeds the requirements of The Building Regulations Approved Document L1 & L2 for airtightness.
- Independently performance tested by BRE for airtightness to BS EN 13141-1 2019 and BS 5250 2021.
- Helps to reduce acoustic noise transmission between the ceiling and loft space.

DESCRIPTION	FRAME FITTING SIZE	CLEAR OPENING SIZE	INSULATION U-VALUE	INSULATION DEPTH	PRODUCT CODES	LEAD TIME
Loftite Hinged Drop Down Loft Door	560 x 740mm	522 x 704mm	0.15 W/m ² K	185mm	LT0015	NWD
Loftite Hinged Drop Down Loft Door with key lock	560 x 740mm	522 x 704mm	0.15 W/m ² K	185mm	LT0015KL	NWD
Loftite Hinged Drop Down Loft Door	560 x 740mm	522 x 704mm	0.25 W/m ² K	110mm	LT0025	NWD
Loftite Hinged Drop Down Loft Door with key lock	560 x 740mm	522 x 704mm	0.25 W/m ² K	110mm	LT0025KL	NWD
Loftite Hinged Drop Down Loft Door	560 x 740mm	522 x 704mm	0.35 W/m ² K	75mm	LT0035	NWD
Loftite Hinged Drop Down Loft Door with key lock	560 x 740mm	522 x 704mm	0.35 W/m ² K	75mm	LT0035KL	NWD



PUSH-UP PLASTIC LOFT DOOR



USE

- Push-up loft door designed to provide easy through-ceiling access into the loft space
- Ready to fit straight out of the box with two twist-operated catches to secure the door in place
- Available in 3 U-value options

PRODUCT CODE	FRAME FITTING SIZE	CLEAR OPENING SIZE	INSULATION U-VALUE	PACK QUANTITY	LEAD TIME
1168	562 x 665mm	526 x 626mm	0.82 W/m ² k	1	Next Working Day
1168/35	562 x 665mm	526 x 626mm	0.35 W/m ² k	1	Next Working Day
1168/25	562 x 665mm	526 x 626mm	0.25 W/m ² k	1	Next Working Day



HINGED PLASTIC LOFT DOOR

USE

- Hinged drop-down loft door designed to provide easy through-ceiling access into the loft space
- Ready to fit straight out of the box with a twist-operated catch to secure the door in place
- Available in 3 U-values and key lock options



PRODUCT CODE	KEY LOCK	FRAME FITTING SIZE	CLEAR OPENING SIZE	INSULATION U-VALUE	PACK QUANTITY	LEAD TIME
1169	No	562 x 662mm	526 x 626mm	0.82 W/m ² k	1	Next Working Day
1169KL	Yes	562 x 662mm	526 x 626mm	0.82 W/m ² k	1	Next Working Day
1169/35	No	562 x 662mm	526 x 626mm	0.35 W/m ² k	1	Next Working Day
1169/35KL	Yes	562 x 662mm	526 x 626mm	0.35 W/m ² k	1	Next Working Day
1169/25	No	562 x 662mm	526 x 626mm	0.25 W/m ² k	1	Next Working Day
1169/25KL	Yes	562 x 662mm	526 x 626mm	0.25 W/m ² k	1	Next Working Day

Z-SERIES



1-HOUR FIRE-RATED METAL LOFT DOOR

USE

- Hinged metal loft door for use where fire protection is required
- Twist operated catch to release a hinged, downward opening door. Available in 2 lock options and 2 insulation u-values

Determine the required product by using the table below:

LOCK TYPE	BUDGET LOCK	U-VALUE	
		0.82 W/m ² k	0.35 W/m ² k
		Z800...	Z900...
	KEY LOCK	ZKL800...	ZKL900...

BUDGET LOCK CODE	KEY LOCK CODE	FRAME FITTING SIZE	CLEAR OPENING SIZE	OVERALL FRAME SIZE	INSULATION U-VALUE	PACK QUANTITY	LEAD TIME
Z8001	ZKL8001	555 x 555mm	528 x 500mm	598 x 598mm	0.82 W/m ² k	1	Next Working Day
Z8002	ZKL8002	560 x 805mm	533 x 750mm	603 x 848mm	0.82 W/m ² k	1	Next Working Day
Z8003	ZKL8003	542 x 630mm	520 x 580mm	590 x 680mm	0.82 W/m ² k	1	Next Working Day
Z8004	ZKL8004	542 x 745mm	520 x 695mm	590 x 795mm	0.82 W/m ² k	1	Next Working Day
Z8005	ZKL8005	605 x 605mm	578 x 550mm	648 x 648mm	0.82 W/m ² k	1	Next Working Day
Z8006	ZKL8006	605 x 905mm	578 x 850mm	648 x 948mm	0.82 W/m ² k	1	Next Working Day
Z8007*	ZKL8007*	905 x 605mm	850 x 578mm	948 x 648mm	0.82 W/m ² k	1	Next Working Day
Z8008*	ZKL8008*	1205 x 605mm	1178 x 550mm	1248 x 648mm	0.82 W/m ² k	1	Next Working Day

BUDGET LOCK CODE	KEY LOCK CODE	FRAME FITTING SIZE	CLEAR OPENING SIZE	OVERALL FRAME SIZE	INSULATION U-VALUE	PACK QUANTITY	LEAD TIME
Z9001	ZKL9001	555 x 555mm	528 x 500mm	598 x 598mm	0.35 W/m ² k	1	Next Working Day
Z9002	ZKL9002	560 x 805mm	533 x 750mm	603 x 848mm	0.35 W/m ² k	1	Next Working Day
Z9003	ZKL9003	542 x 630mm	520 x 580mm	590 x 680mm	0.35 W/m ² k	1	Next Working Day
Z9004	ZKL9004	542 x 745mm	520 x 695mm	590 x 795mm	0.35 W/m ² k	1	Next Working Day
Z9005	ZKL9005	605 x 605mm	578 x 550mm	648 x 648mm	0.35 W/m ² k	1	Next Working Day
Z9006	ZKL9006	605 x 905mm	578 x 850mm	648 x 948mm	0.35 W/m ² k	1	Next Working Day
Z9007*	ZKL9007*	905 x 605mm	850 x 578mm	948 x 648mm	0.35 W/m ² k	1	Next Working Day
Z9008*	ZKL9008*	1205 x 605mm	1178 x 550mm	1248 x 648mm	0.35 W/m ² k	1	Next Working Day

*Hinged on long side

LOFT-LOC LOFT DOOR POLES

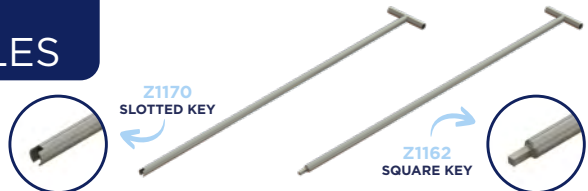

PRODUCT CODE	DESCRIPTION	USE	DIMENSIONS	PACK QUANTITY	LEAD TIME
Z1162	Square T-Key	Metal Hinged Loft Access Door	600 x 12 x 75mm	1	Next Working Day
Z1170	Slotted	Plastic Push-Up or Hinged Loft Access Door	600 x 12 x 75mm	1	Next Working Day

ACCESS PANELS

PLASTIC ACCESS PANELS



USE

- Solution for providing access to services and connections behind dry lined walls, ducts, cupboards and ceilings (ex. AP450 & AP450KL)
- Ideal for meeting gas safety industry and Building Regulation Part J's concealed boiler flue inspection access requirements (non-fire rated applications)



PRODUCT CODE	DOOR TYPE	KEY LOCK	FRAME FITTING SIZE	CLEAR OPENING SIZE	OVERALL FRAME SIZE	PACK QUANTITY	LEAD TIME
AP110	Clip fit	No	115 x 165mm	100 x 150mm	135 x 185mm	1	Next Working Day
AP150	Hinged	No	155 x 235mm	140 x 220mm	195 x 275mm	1	Next Working Day
AP200	Clip fit	No	205 x 205mm	190 x 190mm	245 x 245mm	1	Next Working Day
AP300	Hinged	No	305 x 305mm	290 x 290mm	345 x 345mm	1	Next Working Day
AP450*	Hinged	No	470 x 470mm	455 x 455mm	510 x 510mm	1	Next Working Day
AP150KL	Hinged	Yes	155 x 235mm	140 x 220mm	195 x 275mm	1	Next Working Day
AP300KL	Hinged	Yes	305 x 305mm	290 x 290mm	345 x 345mm	1	Next Working Day
AP450KL*	Hinged	Yes	470 x 470mm	455 x 455mm	510 x 510mm	1	Next Working Day

*Not suitable for ceiling installations

Airtight seal reduces air permeability to 0.00/h.m at +50pa



AIRTIGHT PLASTIC ACCESS PANELS

USE

- Solution for providing access to services and connections behind dry lined walls, ducts, cupboards and ceilings
- Ideal for meeting gas safety industry and Building Regulation Part J's concealed boiler flue inspection access requirements (non-fire rated applications)

Helps to meet the requirements of:

- **Building Regulation Part L1 & L2** - Conservation of Fuel and Power (air leakage)
- **Building Regulation Part J** - Heat Producing Appliances (concealed boiler flue inspection access)
- **Building Regulation Part E** - Resistance to Sound

PRODUCT CODE	FRAME FITTING SIZE	CLEAR OPENING SIZE	OVERALL FRAME SIZE	DOOR TYPE	PACK QUANTITY	LEAD TIME
AP110AT	115 x 165mm	100 x 150mm	135 x 185mm	Clip fit	1	Next Working Day
AP150AT	155 x 235mm	140 x 220mm	195 x 275mm	Clip fit	1	Next Working Day
AP200AT	205 x 205mm	190 x 190mm	245 x 245mm	Clip fit	1	Next Working Day
AP300AT	305 x 305mm	290 x 290mm	345 x 345mm	Clip fit	1	Next Working Day
AP450AT	470 x 470mm	455 x 455mm	510 x 510mm	Clip fit	1	Next Working Day

Z-SERIES METAL ACCESS PANELS

USE

- To provide access to services and connections
- For applications where plastic access panels are not suitable and a fire rating is not required
- Ideal for meeting the gas safety industry and Building Regulation Part J's concealed boiler flue inspection access requirements (non-fire rated applications)



PRODUCT CODE	FRAME FITTING SIZE	CLEAR OPENING SIZE	OVERALL PANEL & FRAME SIZE	PACK QUANTITY	LEAD TIME
Z2001	155 x 155mm	128 x 110mm	198 x 198mm	1	Next Working Day
Z2002	155 x 235mm	110 x 208mm	198 x 278mm	1	Next Working Day
Z2003	205 x 205mm	178 x 160mm	248 x 248mm	1	Next Working Day
Z2004	305 x 305mm	278 x 260mm	348 x 348mm	1	Next Working Day
Z2005	355 x 355mm	328 x 310mm	398 x 398mm	1	Next Working Day
Z2006	455 x 455mm	428 x 410mm	498 x 498mm	1	Next Working Day
Z2007	555 x 555mm	528 x 518mm	598 x 598mm	1	Next Working Day
Z2008	605 x 305mm	578 x 260mm	648 x 348mm	1	Next Working Day
Z2009	605 x 605mm	578 x 560mm	648 x 648mm	1	Next Working Day



METAL 1-HOUR FIRE-RATED ACCESS PANELS

USE

- Provides access to services and connections behind dry lined walls and ceilings where a 1-hour fire rating is required
- Projects requiring additional reduced air leakage and/or acoustic performance requirements
- Ideal solution for meeting Part J and the gas safety industry's concealed boiler flue inspection access requirements (1 hour fire-rated applications)

PRODUCT CODE	FRAME FITTING SIZE	CLEAR OPENING SIZE	OVERALL FRAME SIZE	DOOR TYPE	PACK QUANTITY	LEAD TIME
APC150x150CR	155 x 155mm	110 x 110mm	200 x 200mm	T-key lock	1	Next Working Day
APC150x230CR	155 x 235mm	110 x 190mm	200 x 280mm	T-key lock	1	Next Working Day
APC200x200CR	205 x 205mm	160 x 160mm	250 x 250mm	T-key lock	1	Next Working Day
APC300x300CR	305 x 305mm	260 x 260mm	350 x 350mm	T-key lock	1	Next Working Day
APC450x450CR	455 x 455mm	410 x 410mm	500 x 500mm	T-key lock	1	Next Working Day
APC550x550CR	555 x 555mm	510 x 510mm	600 x 600mm	T-key lock	1	Next Working Day
APC600x600CR	605 x 605mm	560 x 560mm	650 x 650mm	T-key lock	1	Next Working Day
APC150x150CRKL	155 x 155mm	110 x 110mm	200 x 200mm	Key lock	1	Next Working Day
APC150x230CRKL	155 x 235mm	110 x 190mm	200 x 280mm	Key lock	1	Next Working Day
APC200x200CRKL	205 x 205mm	160 x 160mm	250 x 250mm	Key lock	1	Next Working Day
APC300x300CRKL	305 x 305mm	260 x 260mm	350 x 350mm	Key lock	1	Next Working Day
APC450x450CRKL	455 x 455mm	410 x 410mm	500 x 500mm	Key lock	1	Next Working Day
APC550x550CRKL	555 x 555mm	510 x 510mm	600 x 600mm	Key lock	1	Next Working Day
APC600x600CRKL	605 x 605mm	560 x 560mm	650 x 650mm	Key lock	1	Next Working Day

RAD-SEAL

by **timloc**

RADIATOR PIPE **GUIDE & SEALS**

Rad-Seal is the effective **radiator pipe guide and seal** designed to help reduce air leakage in homes. Rad-Seal is available in two options: Rad-Seal Recessed and Rad-Seal Face-Fix.

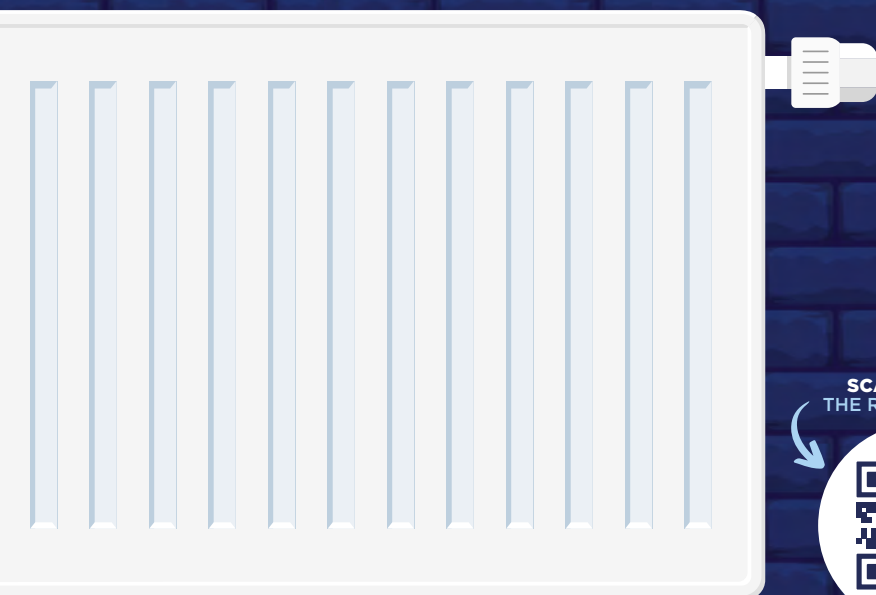

**SCAN TO VIEW
THE RANGE ONLINE**



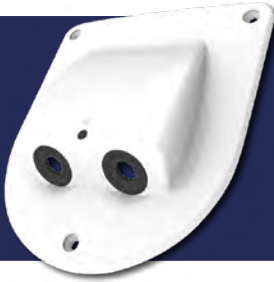

RAD-SEAL 10



Face-fix radiator pipe guide and seal for 10mm pipework.

PRODUCT CODE	HEIGHT	WIDTH	DEPTH	PACK QUANTITY	LEAD TIME
2221	140mm	126mm	23.5mm	20	Next Working Day

RAD-SEAL 15



Face-fix radiator pipe guide and seal for 15mm pipework.

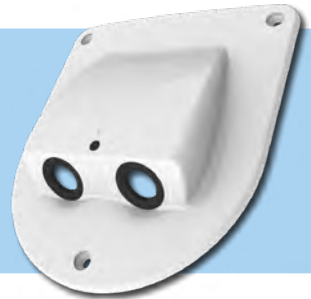

PRODUCT CODE	HEIGHT	WIDTH	DEPTH	PACK QUANTITY	LEAD TIME
2222	140mm	126mm	23.5mm	20	Next Working Day



RAD-SEAL RECESSED

Recessed radiator pipe guide and seal for 10mm pipework.

PRODUCT CODE	DIAMETER	DEPTH	PACK QUANTITY	LEAD TIME
1115	140mm	5mm	10	Next Working Day



EVERYTHING UNDER ONE ROOF

The Roofline by Timloc range encompasses the ancillary products required within a roofing application. Products range from ventilation systems for roofs, eaves and soffits to one-kit solutions for dry ridge and hip installations.

VENTILATION	68
LEAD-FREE FLASHING	73
RIDGE & HIP KITS	74
DRY VERGE	77
SOAKERS	81
ROOF TILE & SLATE VENTS	84



**SCAN TO VIEW
THE RANGE ONLINE**

ROOFLINE

by timloc



VENTILATION

ALLOWING ROOFS TO BREATHE

Ventilation is important, it helps to mitigate condensation, regulate moisture levels, and maintain thermal balance. Continuous circulation helps protect structural timbers, insulation and internal finishes from long-term damage caused by trapped heat or humidity. Our comprehensive range of roof ventilation, ancillary and dry fix installation solutions is engineered to meet industry standards, providing the assurance of proven quality, reliability and durability.

PUSH-IN SOFFIT VENT

USE

- For roof eaves ventilation
- For remedial work on existing roofs
- On roofs where the eaves incorporate a soffit board
- On roofs requiring ventilation equivalent to a 10mm continuous opening



PRODUCT CODE	COLOUR	FREE AIRFLOW	PACK QUANTITY	LEAD TIME
1139	Grey	10,000mm ²	10	Next Working Day
1140	White	10,000mm ²	10	Next Working Day
1141	Black	10,000mm ²	10	Next Working Day
1142	Brown	10,000mm ²	10	Next Working Day



SOFFIT VENT STRIP

USE

- For roof eaves ventilation
- On roofs where the eaves incorporate a soffit board
- With soffit boards of between 6mm and 9mm in thickness

PRODUCT CODE	LENGTH	COLOUR	FREE AIRFLOW	PACK QUANTITY	LEAD TIME
1137WH	2.4m	White	10,000mm ²	10	Next Working Day
1137BR	2.4m	Brown	10,000mm ²	10	Next Working Day
1137BL	2.4m	Black	10,000mm ²	10	Next Working Day
1138WH	2.4m	White	25,000mm ²	10	Next Working Day
1138BR	2.4m	Brown	25,000mm ²	10	Next Working Day



2-IN-1/3-IN-1 EAVES VENT

USE

- For roof eaves ventilation
- On roofs where the eaves incorporate a fascia board
- On roofs which do not incorporate a soffit board or where an unbroken soffit board is required

PRODUCT CODE	EAVES COMB	FREE AIRFLOW	LENGTH	PACK QUANTITY	LEAD TIME
3014	No	10,000mm ²	1m	20	Next Working Day
3014C	Yes	10,000mm ²	1m	10	Next Working Day

FELT SUPPORT TRAY

USE

- At the eaves of a roof to support and protect roofing felt
- For remedial work to replace worn or perished roofing felt



PRODUCT CODE	LENGTH	PACK QUANTITY	LEAD TIME
3017	1500mm	10	Next Working Day
1128	600mm	20	Next Working Day

PRODUCT CODE	LENGTH	PALLET QUANTITY	LEAD TIME
4017	1500mm	1000 Unbagged	Next Working Day



EAVES BIRD COMB FILLER

USE

- At the eaves of a roof
- Below profiled roof tiles to exclude birds and vermin

PRODUCT CODE	LENGTH	PACK QUANTITY	LEAD TIME
1136	1m	50	Next Working Day



All of our ventilation products are designed with ease of installation in mind, ensuring quick, straightforward fitting without compromising on performance.

Scan the QR code to view the installation advice.

300MM OVER FASCIA VENT

USE

- For roof eaves ventilation
- For flat roof abutment ventilation
- On roofs where the eaves incorporate a fascia board
- On roofs which do not incorporate a soffit board, or where an unbroken soffit board is required



PRODUCT CODE	FREE AIRFLOW	LENGTH	COLOUR	PACK QUANTITY	LEAD TIME
3011BL	10,000mm ²	300mm	Black	10	Next Working Day
3011WH	10,000mm ²	300mm	White	10	Next Working Day
3011/25BL	25,000mm ²	300mm	Black	10	Next Working Day
3011/25W	25,000mm ²	300mm	White	10	Next Working Day



1M OVER FASCIA VENT

USE

- For roof eaves ventilation
- For flat roof abutment ventilation
- On roofs where the eaves incorporate a fascia board
- On roofs which do not incorporate a soffit board, or where an unbroken soffit board is required

PRODUCT CODE	COLOUR	FREE AIRFLOW	LENGTH	PACK QUANTITY	LEAD TIME
OF1BL	Black	10,000mm ²	1m	25	Next Working Day
OF2BL	Black	25,000mm ²	1m	20	Next Working Day

CORBEL VENT

USE

- For roof eaves ventilation
- On roofs where ventilation equivalent to a continuous 10mm opening is required
- On roofs where the eaves are corbelled masonry finish
- On roofs which do not incorporate a soffit board or fascia board



PRODUCT CODE	LENGTH	FREE AIRFLOW	PACK QUANTITY	LEAD TIME
3012	2.4m	10,000mm ²	10	Next Working Day

ENGINEERED FOR EFFICIENCY



RAFTER ROLL

USE

- For pitched roof eaves ventilation
- On standard pitched roofs where the pitch is 15° or more and the roof void is an attic or loft space
- On roofs with rafter spacings between 400mm and 600mm centres

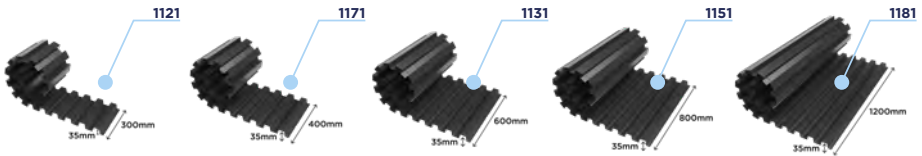

PRODUCT CODE	LENGTH	WIDTH	PACK QUANTITY	LEAD TIME
1121	6m	300mm	10	Next Working Day
1171	6m	400mm	12	Next Working Day
1131	6m	600mm	5	Next Working Day
1151	6m	800mm	6	Next Working Day
1181	6m	1200mm	5	Next Working Day

6M EAVES VENT PACK

USE

- For pitched roof eaves ventilation
- On standard pitched roofs
- On roofs with rafter spacings of between 400mm and 600mm



1 x Rafter Roll (300mm or 600mm width) | 6 x 1m Over Fascia Vent (10,000mm² or 25,000mm² airflow) | 10 x Felt Support Tray (600mm)

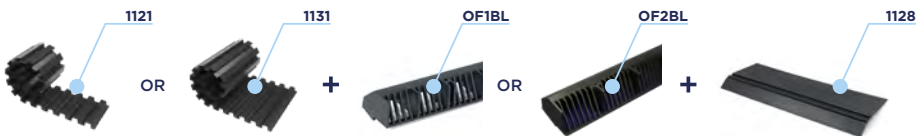

PRODUCT CODE	FREE AIRFLOW	ROLL FORM VENT WIDTH	LEAD TIME
EVP6	10,000mm ²	300mm	Next Working Day
EVP6/25	25,000mm ²	300mm	Next Working Day
EVP6/600	10,000mm ²	600mm	Next Working Day
EVP6/25600	25,000mm ²	600mm	Next Working Day

Cooler temperatures increase the risk of

CONDENSATION

in the loft space



SOLVE IT
with

LAP VENT

A remedial solution for combating condensation in cold roof voids by separating lap joints in the roofing felt/membrane and can be fitted retrospectively after increased loft insulation.



PRODUCT CODE

5560

FREE AIRFLOW

3,000mm²

PACK QUANTITY

10

LEAD TIME

Next Working Day

82

Pb FREE

LEAD-FREE FLASHING

USE

- Same applications as traditional lead flashing including flat roof connection, dormers, valley gutters, step and cover flashing, cavity walls and apron flashing
- Can be used in any climate worldwide (-40°C/+90°C)



NEW
SMOOTH
OPTION



The lead alternative, high-performance aluminium flashing. For the same applications as traditional lead flashing including flat roof connection, dormers, valley gutters, step and cover flashing, cavity walls and apron flashing.

PRODUCT CODE	DESCRIPTION	ROLL WIDTH	LENGTH	PACK QUANTITY	LEAD TIME
LF150	PbFree Lead-free Flashing	150mm	5m	1	Next Working Day
LF300	PbFree Lead-free Flashing	300mm	5m	1	Next Working Day
LF450	PbFree Lead-free Flashing	450mm	5m	1	Next Working Day
SLF150	Smooth PbFree Lead-free Flashing	150mm	5m	1	Next Working Day
SLF300	Smooth PbFree Lead-free Flashing	300mm	5m	1	Next Working Day
SLF450	Smooth PbFree Lead-free Flashing	450mm	5m	1	Next Working Day

DRY FIX RIDGE KITS



**DRY FIX
RIDGE KIT**

For use with most types of slate, concrete or clay roof ridge tiles on roof pitches between 15-55°. The ridge union has adjustable clips positions compatible with ridge tiles up to 30mm thickness.



**INTEGRATED DRY
FIX RIDGE KIT**

For use with most types of slate, concrete or clay roof ridge tiles on roof pitches between 15-55°. The ridge union has integrated clips compatible with ridge tiles up to 18mm thickness.

DRY FIX RIDGE KIT

USE

- Most types of slate, concrete or clay roof tiles
- Round or angled ridge tiles
- Most pitched roof types from 15-55°
- New build and retro-fit projects

6M PACK:

- 1 x 6m ridge roll with self-adhesive flashing*
- 13 x fixing screws, washers and clamping plates*
- 13 x ridge unions
- 26 x ridge clips
- 10 x ridge batten straps



10M PACK:

- 1 x 10m ridge roll with self-adhesive flashing*
- 26 x fixing screws, washers and clamping plates*
- 26 x ridge unions
- 52 x ridge clips
- 20 x ridge batten straps

PRODUCT CODE	DESCRIPTION	COLOUR	LEAD TIME
54700	6m Dry Fix Ridge Kit	Black	Next Working Day
51700	10m Dry Fix Ridge Kit	Black	Next Working Day

* Please note, roll flashing and clamping plate colours may vary.

**INTEGRATED
RIDGE CLIPS**
for easy
installation



INTEGRATED DRY FIX RIDGE KIT

USE

- Most types of slate, concrete or clay roof tiles
- Round or angled ridge tiles
- Most pitched roof types from 15-55°
- New build and retro-fit projects

3M PACK:

- 1 x 3m ridge roll with self-adhesive flashing*
- 7 x fixing screws, washers and clamping plates*
- 7 x ridge unions with integrated clips
- 5 x ridge batten straps

6M PACK:

- 1 x 6m ridge roll with self-adhesive flashing*
- 13 x fixing screws, washers and clamping plates*
- 13 x ridge unions with integrated clips
- 10 x ridge batten straps

PRODUCT CODE	DESCRIPTION	COLOUR	LEAD TIME
53700	3m Integrated Dry Fix Ridge Kit	Black	Next Working Day
54703	6m Integrated Dry Fix Ridge Kit	Black	Next Working Day

* Please note, roll flashing and clamping plate colours may vary.

DRY FIX CLAY RIDGE KIT

USE

- Most types of clay roof tiles
- Round or angled ridge tiles
- Most pitched roof types from 15-55°
- New build and retro-fit projects

PACK CONTAINS:

- 1 x 6m ridge roll with self-adhesive flashing*
- 20 x fixing screws, washers and clamping plates*
- 20 x ridge unions
- 40 x ridge union clips
- 10 x ridge batten straps

* Please note, roll flashing and clamping plate colours may vary.



PRODUCT CODE	DESCRIPTION	LEAD TIME
54713	6m Dry Fix Clay Ridge Kit	Next Working Day

NEED SOMETHING EXTRA?



PRODUCT CODE	DESCRIPTION	LEAD TIME
54618	13x ridge unions & 26x ridge clips	Next Working Day
54626	13x fixing screws & clamping plates	Next Working Day

DRY FIX HIP KITS



DRY FIX HIP KIT

USE

- Most types of slate, concrete or clay hip tiles
- Round or angled hip tiles
- Most pitched roof types from 15-55°
- New build and retro-fit projects

PACK CONTAINS:

- 1 x 6m ridge roll with self-adhesive flashing*
- 6 x hip trays
- 13 x fixing screws, washers and clamping plates*
- 13 x ridge unions
- 26 x ridge union clips
- 10 x ridge batten straps

PRODUCT CODE	DESCRIPTION	COLOUR	LEAD TIME
54710	6m Dry Fix Hip Kit	Black	Next Working Day
54618	13 x Ridge Unions & 26 x Ridge Clips	Black	Next Working Day
54626	13 x Fixing Screws & Clamping Plates	N/A	Next Working Day

* Please note, roll flashing and clamping plate colours may vary.

HIP TRAY PACK

USE

- Most types of slate, concrete or clay hip tiles
- Round or angled hip tiles
- Most pitched roof types from 15-55°
- New build and retro-fit projects



PRODUCT CODE	DESCRIPTION	PACK QTY	LEAD TIME
44623	Hip Trays Pack	6	Next Working Day

PRODUCT CODE	DESCRIPTION	PALLET QTY	LEAD TIME
44625	Hip Trays Unbagged	1000	Next Working Day



PRODUCT CODE	DESCRIPTION	LEAD TIME
44630	Top & Tail clips (20x large & 20x small) Kit	Next Working Day

HIP CLIPS KIT

USE

- Most types of slate, concrete or clay hip tiles
- Round or angled hip tiles
- Most pitched roof types from 15-55°
- New build and retro-fit projects

DRY FIX VERGE

UNIVERSAL CAPS & BRACKETS



USE

• With Ambi-Verge, Handed, Interlocking Plain and Thin Leading Edge verge systems from Timloc Building Products.



PRODUCT CODE					DESCRIPTION	PACK QUANTITY	LEAD TIME
GREY	BROWN	BLACK	TERRACOTTA	RED			
99109	99108	99107	99110	99183	Universal angled ridge cap	10	Next Working Day
99113	99112	99136	99114	99184	Universal round ridge cap	10	Next Working Day

PRODUCT CODE	DESCRIPTION	PACK QUANTITY	LEAD TIME
99124	Universal end grain batten bracket	20	Next Working Day

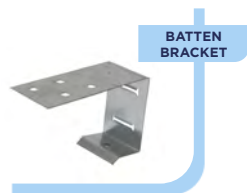

AMBI-VERGE

A universal dry fix verge system for profiled roof tiles is a robust, attractive, and weather-resistant alternative to traditional wet mortar bedding.

USE

- Large format and interlocking concrete profiled tiles
- Most pitched roof types from 15-55°
- Verges with or without bargeboards
- New build and refurbishment projects

PRODUCT CODE				DESCRIPTION	PACK QUANTITY	LEAD TIME
GREY	BROWN	BLACK	TERRACOTTA			
99141	99142	99143	99144	Ambi-Verge dry fix verge piece	20	Next Working Day
99153	99155	99154	99156	Ambi-Verge eaves starter	8	Next Working Day

HANDED DRY FIX VERGE



USE

- Large format, interlocking concrete and clay profiled tiles
- Batten gauges between 260-345mm
- Most pitched roof types from 15-55°
- Verges with or without bargeboards
- New build and refurbishment projects



A premium and weather-resistant verge system alternative to traditional wet mortar bedding. Designed to be strong but flexible for easy flexing and sliding along roof tiles.



PRODUCT CODE				DESCRIPTION	PACK QUANTITY	LEAD TIME
GREY	BROWN	BLACK	TERRACOTTA			
99117	99116	99137	99118	Dry fix verge right hand piece	20	Next Working Day
99121	99120	99138	99122	Dry fix verge left hand piece	20	Next Working Day
99126	99125	99130	99127	Dry fix verge eaves starter pack (L+R)	1 + 1	Next Working Day



INTERLOCKING PLAIN DRY FIX VERGE

A robust, attractive and weather resistant verge system alternative to wet mortar bedding for Interlocking Plain tiles.

USE

- Developed for Interlocking Plain concrete tiles
- Suitable for most pitched roof types from 15-55°
- Verges with or without bargeboards
- New build and refurbishment projects



PRODUCT CODE					DESCRIPTION	PACK QUANTITY	LEAD TIME
GREY	BROWN	BLACK	TERRACOTTA	RED			
99174	99176	99173	99175	99182	Interlocking Plain verge	40	Next Working Day
99178	99180	99177	99179	99181	Interlocking Plain eaves starter	10	Next Working Day

THIN LEADING EDGE DRY FIX VERGE



USE

- Developed for Thin Leading Edge roof tiles
- Suitable for most pitched roof types from 15-55°
- Verges with or without bargeboards
- New build and refurbishment projects

A robust, attractive and weather resistant verge system alternative to wet mortar bedding for Thin Leading Edge tiles.



PRODUCT CODE				DESCRIPTION	PACK QUANTITY	LEAD TIME
GREY	BROWN	BLACK	TERRACOTTA			
99158	99160	99157	99159	Thin Leading Edge verge (LH)	20	Next Working Day
99162	99164	99161	99163	Thin Leading Edge verge (RH)	20	Next Working Day
99166	99168	99165	99167	Thin Leading Edge eaves starter (LH)	10	Next Working Day
99170	99172	99169	99171	Thin Leading Edge eaves starter (RH)	10	Next Working Day

A continuous verge system, for slate and flat tiles, that presents a clean flush finish and an effective and virtually maintenance free alternative to wet mortar bedding.



CONTINUOUS DRY FIX VERGE

USE

- Slate and tile thickness between 4 - 13mm slate and slate-effect tiles



PRODUCT CODE	DESCRIPTION	PACK QTY	LEAD TIME
66101	Continuous verge 3m piece - New build	4	Next Working Day
66105	Continuous verge 3m piece - Refurbishment	4	Next Working Day
66120	Continuous Verge angled ridge cap	1	Next Working Day
66117	Continuous verge eaves starter pair (L+R)	1 + 1	Next Working Day
66124	Continuous verge joint union	1	Next Working Day

DRY FIX LEAD REPLACEMENT SOAKERS

Patented 'snip off'
soakers for universal
fixing

Soakers help to prevent any water ingress at the abutment to a wall and provide an aesthetic finish



Simple on-site installation

Compatibility chart available

Cost-saving Lead alternative

Fitting instructions available

Easy snip tab for universal fixing

UV-protected & colourfast Polypropylene

Comprehensive chart of the compatible soakers available from Timloc Building Products to suit popular roof tiles and slates. **If the tile or slate you are using is not listed please get in touch to discuss compatible options to suit your project requirements.**

CODE	DESCRIPTION	COMPATIBILITY		IMAGE
AS-PLAIN	Plain Tiles	Most Plain tiles from major manufacturers including: • Redland Rosemary • Marley Plain • Russell Traditional Plain • Sandtoft Humber Plain		
AS-INTPLAIN	Interlocking Plain Tiles	Most Interlocking Plain tiles from major manufacturers including: • Marley Ashmore • Redland Duoplain • Forticrete Gemini		
AS-SLATE	Slates	Natural or Synthetic Slates Slate sizes 600mm x 300mm or 500mm x 250mm Product can be trimmed to suit smaller slate sizes if required		
AS-TLE	Thin Leading Edge Tiles	Most Thin Leading Edge large format tiles from major manufacturers including: • Marley Edgemere • Redland Richmond • Sandtoft TLE • Russell Galloway • Lagan Elite		
AS-FLAT	Flat Tiles	Most Flat large format tiles from major manufacturers including: • Marley Modern • Marley Duo Modern • Redland Mini Stonewold • Sandtoft Calderdale • Russell Grampian • Russell Highland • Lagan Flat		

PLAIN



USE

- Traditional Plain Clay Tiles
- Abutments between a pitched roof and a wall
- New build or refurbishment projects

INTERLOCKING PLAIN



USE

- Interlocking Plain Tiles
- Abutments between a pitched roof and a wall
- New build or refurbishment projects

SLATE

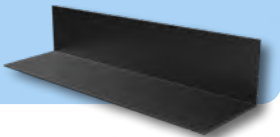

USE

- Natural or Synthetic slates
- Abutments between a pitched roof and a wall
- New build or refurbishment projects

THIN LEADING EDGE

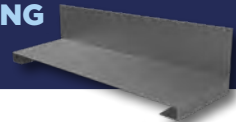

USE

- Thin Leading Edge Tiles
- Abutments between a pitched roof and a wall
- New build or refurbishment projects

FLAT

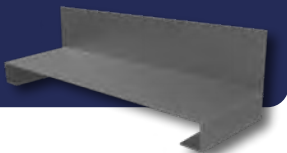

USE

- Large Format Flat Tiles
- Abutments between a pitched roof and a wall
- New build or refurbishment projects



AS

AMBI-SOAKER

PRODUCT CODE	DESCRIPTION	COLOUR	DIMENSIONS (HxLxW)	PACK QUANTITY	LEAD TIME
AS-PLAIN	Plain	Black	80 x 170 x 100mm	50	Next Working Day
AS-INTPLAIN	Interlocking Plain	Black	80 x 240 x 100mm	40	Next Working Day
AS-SLATE	Slate	Black	80 x 400 x 100mm	50	Next Working Day
AS-TLE	Thin Leading Edge	Grey	98.5 x 432 x 125mm	50	Next Working Day
AS-FLAT	Flat	Grey	114 x 432 x 125mm	30	Next Working Day

TRIED. TESTED. TRUSTED.

Timloc Building Products' InVentive range of roof tile and slate vents has successfully undergone BRE testing to PD CEN/TR 15601 for resistance to wind-driven rain, giving further assurance of quality and reliability.

Each test is a thorough evaluation of the vents' impact on roof weather tightness. The results speak for themselves – every vent tested successfully maintained the roof's weatherproof performance, providing proven protection and long-term reliability.



SCAN TO
LEARN MORE



INVENTIVE

Roof ventilation solutions

Available in **single, pack, and pallet** quantities



Designed to suit **popular tile and slate** types

Next day delivery on the entire product range

Tested to PD CEN/TR 15601 **against wind driven rain**



Full range of **adapters and accessories** available

Comprehensive range of **tile and slate vents** from

timloc
building products

Available Colours: ● Terracotta | TE ● Brown | BR ● Red | RD ● Grey | GR ● Black | BL
 Add the required colour option code to the end of the product code when ordering e.g. RTV-CTE

FP MCCANN

Tile Type	Vent Code	Vent Name	Min. Pitch	Colours
Double Roman	RTV-DR	Double Roman	20°	●●●●●
Square Top	RTV-C	Castellated	20°	●●●●●
Thin Flat Tile	RTV-TE	Thin Leading Edge	20°	●●●●●●
Duo Thin Flat Tile	RTV-TE	Thin Leading Edge	20°	●●●●●●

FORTICRETE

Tile Type	Vent Code	Vent Name	Min. Pitch	Colours
Forticrete Gemini	RTV-IP	Interlocking Plain	22.5°	●●●●●
Forticrete V2	RTV-MC	Mini Castellated	17.5°	●●●●●

LAGAN

Tile Type	Vent Code	Vent Name	Min. Pitch	Colours
Lagan Double Roll	RTV-DR	Double Roman	20°	●●●●●
Lagan Elite	RTV-TE	Thin Leading Edge	20°	●●●●●●
Lagan Flat	RTV-NP	Non-Profile	20°	●●●●●●
Lagan Square Top	RTV-C	Castellated	20°	●●●●●

MARLEY

Tile Type	Vent Code	Vent Name	Min. Pitch	Colours
Marley Anglia	RTV-SP	Single Pantile	20°	●●●●●
Marley Ashmore	RTV-IP	Interlocking Plain	22.5°	●●●●●
Marley Double Roman	RTV-DR	Double Roman	20°	●●●●●
Marley Duo Modern	RTV-NP	Non-Profile	20°	●●●●●●
Marley Edgemere	RTV-TE	Thin Leading Edge	20°	●●●●●●
Marley Ludlow Major	RTV-C	Castellated	20°	●●●●●
Marley Ludlow Plus	RTV-MC	Mini Castellated	17.5°	●●●●●
Marley Mendip	RTV-DP	Double Pantile	20°	●●●●●
Marley Modern	RTV-NP	Non-Profile	20°	●●●●●●
Marley Plain	RTV-P	Plain	35°	●●●●●
	RTV-LPP	Low Profile Plain		
	RTV-SLIP	Slip Plain		

RUSSELL

Tile Type	Vent Code	Vent Name	Min. Pitch	Colours
Russell Bute	RTV-TE	Thin Leading Edge	20°	●●●●●●
Russell Cheviot	RTV-C	Castellated	20°	●●●●●
Russell Double Roman	RTV-DR	Double Roman	20°	●●●●●
Russell Galloway	RTV-TE	Thin Leading Edge	20°	●●●●●●
Russell Grampian	RTV-NP	Non-Profile	20°	●●●●●●
Russell Highland	RTV-NP	Non-Profile	20°	●●●●●●
Russell Pennine	RTV-DP	Double Pantile	20°	●●●●●
Russell Traditional Plain	RTV-P	Plain	35°	●●●●●
	RTV-LPP	Low Profile Plain		
	RTV-SLIP	Slip Plain		

If the tile or slate you are using is not listed please get in touch to discuss compatible options to suit your project requirements.

QUINN

Tile Type	Vent Code	Vent Name	Min. Pitch	Colours
Quinn Locherne	RTV-DP	Double Pantile	20°	●●●●●

REDLAND

Tile Type	Vent Code	Vent Name	Min. Pitch	Colours
Redland 49	RTV-MC	Mini Castellated	17.5°	●●●●●
Redland 50 Double Roman	RTV-DR	Double Roman	20°	●●●●●
Redland Duoplain	RTV-IP	Interlocking Plain	22.5°	●●●●●
Redland Fenland Pantile	RTV-SP	Single Pantile	20°	●●●●●
Redland Grovebury	RTV-DP	Double Pantile	20°	●●●●●
Redland Landmark	RTV-DP	Double Pantile	20°	●●●●●
Redland Mini Stonewold	RTV-NP	Non-Profile	20°	●●●●●●
Redland Renown	RTV-C	Castellated	20°	●●●●●
Redland Richmond	RTV-TE	Thin Leading Edge	20°	●●●●●●
Redland Rosemary	RTV-P	Plain	35°	●●●●●
	RTV-LPP	Low Profile Plain		
	RTV-SLIP	Slip Plain		

SANDTOFT

Tile Type	Vent Code	Vent Name	Min. Pitch	Colours
Sandtoft Calderdale Edge	RTV-FE	Flat Edge	20°	●●●●●●
Sandtoft Danum	RTV-FE	Flat Edge	20°	●●●●●●
Sandtoft Double Pantile	RTV-DP	Double Pantile	20°	●●●●●
Sandtoft Double Roman	RTV-DR	Double Roman	20°	●●●●●
Sandtoft Calderdale	RTV-NP	Non-Profile	20°	●●●●●●
Sandtoft Lindum	RTV-C	Castellated	20°	●●●●●
Sandtoft Shire	RTV-SP	Single Pantile	20°	●●●●●
Sandtoft Standard Pattern	RTV-MC	Mini Castellated	17.5°	●●●●●
Sandtoft TLE	RTV-TE	Thin Leading Edge	20°	●●●●●
Sandtoft Humber Plain	RTV-P	Plain	35°	●●●●●
	RTV-LPP	Low Profile Plain		
	RTV-SLIP	Slip Plain		

SLATE

Slate Type	Vent Code	Vent Name	Min. Pitch	Colours
All major slates (600x300mm or 500x250mm)	RTV-IS	Inline Slate	22.5°	●
All major slates in smaller sizes (300x200mm to 400x250mm)	RTV-SIS	Small Inline Slate	22.5°	●
All major slates (600x300mm or 500x250mm)	RTV-HS	Hooded Slate	22.5°	●
All major slates (600x300mm or 500x250mm)	4001	Universal Slate	22.5°	●

UNIVERSAL

Tile or Slate Type	Vent Code	Vent Name	Min. Pitch	Colours
All major plain or profiled tiles or slates	RTV-UNI	Universal	12.5°	●●●●●●
All major plain or profiled tiles or slates	RTV-UNI2	Universal 22,000mm ²	12.5°	●●●●●●

INVENTIVE

Roof ventilation solutions

TILE VENTS

Available in single, multi and pallet quantities
Multi = X vents in 1 box (order as each using multi code)



CASTELLATED

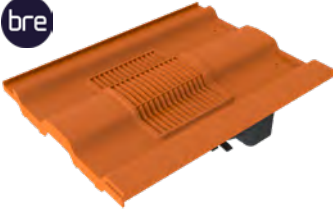

COMPATIBILITY

Castellated large format tiles from all major manufacturers including:

- Marley Ludlow Major
- Redland Renown
- Sandtoft Lindum
- Russell Cheviot
- Lagan Square Top
- FP McCann Square Top

USE

- On roofs with Castellated tiles
- For direct roof space ventilation
- Connected to a ducted ventilation system inside the building



20° min. pitch



10,000mm² free ventilation area



Replaces 1 Castellated tile



UV stabilised PP top

DESCRIPTION	COLOUR	SINGLE CODE	MULTI CODE	MULTI QUANTITY	PALLET QUANTITY	LEAD TIME
Castellated	Terracotta	RTV-CTE	RTVMULTI-CTE	8	136	Next Working Day
Castellated	Brown	RTV-CBR	RTVMULTI-CBR	8	136	Next Working Day
Castellated	Grey	RTV-CGR	RTVMULTI-CGR	8	136	Next Working Day
Castellated	Red	RTV-CRD	RTVMULTI-CRD	8	136	Next Working Day

DOUBLE PANTILE



COMPATIBILITY

Double Pantile large format tiles from all major manufacturers including:

- Marley Mendip
- Redland Grovebury
- Redland Landmark
- Russell Pennine
- Quinn Locherne
- Sandtoft Double Pantile

USE

- On roofs with Double Pantile tiles
- For direct roof space ventilation
- Connected to a ducted ventilation system inside the building



20° min. pitch



10,000mm² free ventilation area



Replaces 1 Double Pantile tile



UV stabilised PP top

DESCRIPTION	COLOUR	SINGLE CODE	MULTI CODE	MULTI QUANTITY	PALLET QUANTITY	LEAD TIME
Double Pantile	Terracotta	RTV-DPTE	RTVMULTI-DPTE	6	102	Next Working Day
Double Pantile	Brown	RTV-DPBR	RTVMULTI-DPBR	6	102	Next Working Day
Double Pantile	Grey	RTV-DPGR	RTVMULTI-DPGR	6	102	Next Working Day
Double Pantile	Red	RTV-DPRD	RTVMULTI-DPRD	6	102	Next Working Day

DOUBLE ROMAN



COMPATIBILITY

Double Roman large format tiles from all major manufacturers including:

- Marley Double Roman
- Redland 50 Double Roman
- Russell Double Roman
- Sandtoft Double Roman
- Lagan Double Roll
- FP McCann Double Roman

USE

- On roofs with Double Roman tiles
- For direct roof space ventilation
- Connected to a ducted ventilation system inside the building



20° min. pitch



10,000mm² free ventilation area



Replaces 1 Double Roman tile



UV stabilised PP top

DESCRIPTION	COLOUR	SINGLE CODE	MULTI CODE	MULTI QUANTITY	PALLET QUANTITY	LEAD TIME
Double Roman	Terracotta	RTV-DRTE	RTVMULTI-DRTE	6	102	Next Working Day
Double Roman	Brown	RTV-DRBR	RTVMULTI-DRBR	6	102	Next Working Day
Double Roman	Grey	RTV-DRGR	RTVMULTI-DRGR	6	102	Next Working Day
Double Roman	Red	RTV-DRRD	RTVMULTI-DRRD	6	102	Next Working Day

FLAT EDGE

bre

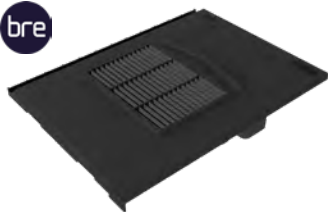

COMPATIBILITY

Flat Edge large format tiles from all major manufacturers including:

- Sandtoft Calderdale Edge
- Sandtoft Danum

USE

- On roofs with Flat Edge tiles
- For direct roof space ventilation
- Connected to a ducted ventilation system inside the building



DESCRIPTION	COLOUR	SINGLE CODE	MULTI CODE	MULTI QUANTITY	PALLET QUANTITY	LEAD TIME
Flat Edge	Terracotta	RTV-FETE	RTVMULTI-FETE	8	136	Next Working Day
Flat Edge	Brown	RTV-FEBR	RTVMULTI-FEBR	8	136	Next Working Day
Flat Edge	Grey	RTV-FEGR	RTVMULTI-FEGR	8	136	Next Working Day
Flat Edge	Red	RTV-FERD	RTVMULTI-FERD	8	136	Next Working Day
Flat Edge	Black	RTV-FEBL	RTVMULTI-FEBL	8	136	Next Working Day

NON-PROFILE

bre

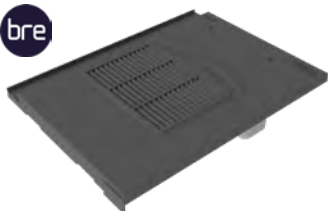

COMPATIBILITY

Non-Profile large format tiles from all major manufacturers including:

- Marley Modern
- Marley Duo Modern
- Redland Mini Stonewold
- Sandtoft Calderdale
- Russell Grampian
- Russell Highland
- Lagan Flat

USE

- On roofs with Non-Profile tiles
- For direct roof space ventilation
- Connected to a ducted ventilation system inside the building



DESCRIPTION	COLOUR	SINGLE CODE	MULTI CODE	MULTI QUANTITY	PALLET QUANTITY	LEAD TIME
Non-Profile	Terracotta	RTV-NPTE	RTVMULTI-NPTE	8	136	Next Working Day
Non-Profile	Brown	RTV-NPBR	RTVMULTI-NPBR	8	136	Next Working Day
Non-Profile	Grey	RTV-NPGR	RTVMULTI-NPGR	8	136	Next Working Day
Non-Profile	Red	RTV-NPRD	RTVMULTI-NPRD	8	136	Next Working Day
Non-Profile	Black	RTV-NPBL	RTVMULTI-NPBL	8	136	Next Working Day

THIN LEADING EDGE

bre



COMPATIBILITY

Thin Leading Edge large format tiles from all major manufacturers including:

- Marley Edgemere
- Redland Richmond
- Sandtoft TLE
- Russell Bute
- Russell Galloway
- Lagan Elite
- FP McCann Thin Flat Tile
- FP McCann Duo Thin Flat Tile

USE

- On roofs with Thin Leading Edge tiles
- For direct roof space ventilation
- Connected to a ducted ventilation system inside the building



DESCRIPTION	COLOUR	SINGLE CODE	MULTI CODE	MULTI QUANTITY	PALLET QUANTITY	LEAD TIME
Thin Leading Edge	Terracotta	RTV-TETE	RTVMULTI-TETE	8	136	Next Working Day
Thin Leading Edge	Brown	RTV-TEBR	RTVMULTI-TEBR	8	136	Next Working Day
Thin Leading Edge	Grey	RTV-TEGR	RTVMULTI-TEGR	8	136	Next Working Day
Thin Leading Edge	Red	RTV-TERD	RTVMULTI-TERD	8	136	Next Working Day
Thin Leading Edge	Black	RTV-TEBL	RTVMULTI-TEBL	8	136	Next Working Day

INVENTIVE

Roof ventilation solutions

TILE VENTS

Available in single, multi and pallet quantities
Multi = X vents in 1 box (order as each using multi code)



MINI CASTELLATED



COMPATIBILITY

Mini Castellated small format tiles from all major manufacturers including:

- Marley Ludlow Plus
- Redland 49
- Sandtoft Standard Pattern
- Forticrete V2

USE

- On roofs with Mini Castellated tiles
- For direct roof space ventilation
- Connected to a ducted ventilation system inside the building



17.5° min. pitch

5,000mm² free ventilation area

Replaces 1 Mini Castellated tile

UV stabilised PP top

DESCRIPTION	COLOUR	SINGLE CODE	MULTI CODE	MULTI QUANTITY	PALLET QUANTITY	LEAD TIME
Mini Castellated	Terracotta	RTV-MCTE	RTVMULTI-MCTE	14	238	Next Working Day
Mini Castellated	Brown	RTV-MCBB	RTVMULTI-MCBB	14	238	Next Working Day
Mini Castellated	Grey	RTV-MCGR	RTVMULTI-MCGR	14	238	Next Working Day
Mini Castellated	Red	RTV-MCRD	RTVMULTI-MCRD	14	238	Next Working Day

SINGLE PANTILE



COMPATIBILITY

Single Pantile small format tiles from all major manufacturers including:

- Marley Anglia
- Redland Fenland Pantile
- Sandtoft Shire

USE

- On roofs with Single Pantile tiles
- For direct roof space ventilation
- Connected to a ducted ventilation system inside the building



20° min. pitch

5,000mm² free ventilation area

Replaces 1 Single Pantile tile

UV stabilised PP top

DESCRIPTION	COLOUR	SINGLE CODE	MULTI CODE	MULTI QUANTITY	PALLET QUANTITY	LEAD TIME
Single Pantile	Terracotta	RTV-SPTE	RTVMULTI-SPTE	11	187	Next Working Day
Single Pantile	Brown	RTV-SPBR	RTVMULTI-SPBR	11	187	Next Working Day
Single Pantile	Grey	RTV-SPGR	RTVMULTI-SPGR	11	187	Next Working Day
Single Pantile	Red	RTV-SPRD	RTVMULTI-SPRD	11	187	Next Working Day

INTERLOCKING PLAIN

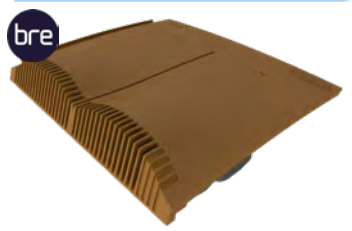

COMPATIBILITY

Interlocking Plain tiles from all major manufacturers including:

- Marley Ashmore
- Redland Duoplain
- Forticrete Gemini

USE

- On roofs with Interlocking Plain tiles
- For direct roof space ventilation
- Connected to a ducted ventilation system inside the building



22.5° min. pitch

6,000mm² free ventilation area

Replaces 1 Interlock Plain tile

UV stabilised PP top

DESCRIPTION	COLOUR	SINGLE CODE	MULTI CODE	MULTI QUANTITY	PALLET QUANTITY	LEAD TIME
Interlocking Plain	Terracotta	RTV-IPTE	RTVMULTI-IPTE	12	204	Next Working Day
Interlocking Plain	Brown	RTV-IPBR	RTVMULTI-IPBR	12	204	Next Working Day
Interlocking Plain	Grey	RTV-IPGR	RTVMULTI-IPGR	12	204	Next Working Day
Interlocking Plain	Red	RTV-IPRD	RTVMULTI-IPRD	12	204	Next Working Day

PLAIN

bre



COMPATIBILITY

Plain tiles from all major manufacturers including:

- Redland Rosemary
- Marley Plain
- Russell Traditional Plain
- Sandtoft Humber Plain

USE

- On roofs with Plain tiles
- For direct roof space ventilation
- Connected to a ducted ventilation system inside the building



35° min. pitch

7,000mm² free ventilation area

Replaces 3 Plain tiles

UV stabilised PP top

DESCRIPTION	COLOUR	SINGLE CODE	MULTI CODE	MULTI QUANTITY	PALLET QUANTITY	LEAD TIME
Plain	Terracotta	RTV-PTE	RTVMULTI-PTE	14	238	Next Working Day
Plain	Brown	RTV-PBR	RTVMULTI-PBR	14	238	Next Working Day
Plain	Grey	RTV-PGR	RTVMULTI-PGR	14	238	Next Working Day
Plain	Red	RTV-PRD	RTVMULTI-PRD	14	238	Next Working Day

LOW PROFILE PLAIN

bre

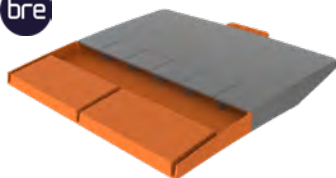

COMPATIBILITY

Plain tiles from all major manufacturers including:

- Redland Rosemary
- Marley Plain
- Russell Traditional Plain
- Sandtoft Humber Plain

USE

- On roofs with Plain tiles
- For direct roof space ventilation
- Connected to a ducted ventilation system inside the building



35° min. pitch

6,100mm² free ventilation area

Replaces 2 Plain tiles

UV stabilised PP top

DESCRIPTION	COLOUR	SINGLE CODE	MULTI CODE	MULTI QUANTITY	PALLET QUANTITY	LEAD TIME
Low Profile Plain	Terracotta	RTV-LPTE	RTVMULTI-LPTE	14	238	Next Working Day
Low Profile Plain	Brown	RTV-LPBR	RTVMULTI-LPBR	14	238	Next Working Day
Low Profile Plain	Grey	RTV-LPGR	RTVMULTI-LPGR	14	238	Next Working Day
Low Profile Plain	Red	RTV-LPPRD	RTVMULTI-LPPRD	14	238	Next Working Day

SLIP PLAIN

bre

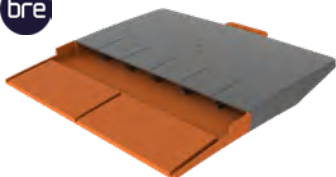

COMPATIBILITY

Plain tiles from all major manufacturers including:

- Redland Rosemary
- Marley Plain
- Russell Traditional Plain
- Sandtoft Humber Plain

USE

- On roofs with Plain tiles
- For direct roof space ventilation
- Connected to a ducted ventilation system inside the building



35° min. pitch

6,100mm² free ventilation area

Replaces 2 Plain tiles

UV stabilised PP top

DESCRIPTION	COLOUR	SINGLE CODE	MULTI CODE	MULTI QUANTITY	PALLET QUANTITY	LEAD TIME
Slip Plain	Terracotta	RTV-SLIPT	RTVMULTI-SLIPT	14	238	Next Working Day
Slip Plain	Brown	RTV-SLIPBR	RTVMULTI-SLIPBR	14	238	Next Working Day
Slip Plain	Grey	RTV-SLIPGR	RTVMULTI-SLIPGR	14	238	Next Working Day
Slip Plain	Red	RTV-SLIPRD	RTVMULTI-SLIPRD	14	238	Next Working Day

INVENTIVE

Roof ventilation solutions

TILE VENTS

Available in single, multi and pallet quantities
Multi = X vents in 1 box (order as each using multi code)



UNIVERSAL



COMPATIBILITY

All types of tile or slate roof covering - Alternative lead flashing.

- 170mm Ø = 20,000mm²
- 150mm Ø = 16,000mm²
- 125mm Ø = 11,000mm²
- 110mm Ø = 8,400mm²

USE

- On roofs with any tile or slate
- For direct roof space ventilation
- Connected to a ducted ventilation system inside the building



12.5° min. pitch

20,000mm² free ventilation area

Replaces 1 tile or slate

UV stabilised PP top

DESCRIPTION	COLOUR	SINGLE CODE	MULTI CODE	MULTI QUANTITY	PALLET QUANTITY	LEAD TIME
Universal	Terracotta	RTV-UNITE	RTVMULTI-UNITE	4	60	Next Working Day
Universal	Brown	RTV-UNIBR	RTVMULTI-UNIBR	4	60	Next Working Day
Universal	Grey	RTV-UNIGR	RTVMULTI-UNIGR	4	60	Next Working Day
Universal	Red	RTV-UNIRD	RTVMULTI-UNIRD	4	60	Next Working Day
Universal	Black	RTV-UNIBL	RTVMULTI-UNIBL	4	60	Next Working Day

UNIVERSAL 22,000



COMPATIBILITY

All types of tile or slate roof covering - Alternative lead flashing.

- 170mm Ø = 22,000mm²
- 150mm Ø = 16,000mm²
- 125mm Ø = 11,000mm²
- 110mm Ø = 8,400mm²

USE

- On roofs with any tile or slate
- For direct roof space ventilation
- Connected to a ducted ventilation system inside the building



12.5° min. pitch

22,000mm² free ventilation area

Replaces 1 tile or slate

UV stabilised PP top

DESCRIPTION	COLOUR	SINGLE CODE	MULTI CODE	MULTI QUANTITY	PALLET QUANTITY	LEAD TIME
Universal 22,000	Terracotta	RTV-UNI2TE	RTVMULTI-UNI2TE	4	60	Next Working Day
Universal 22,000	Brown	RTV-UNI2BR	RTVMULTI-UNI2BR	4	60	Next Working Day
Universal 22,000	Grey	RTV-UNI2GR	RTVMULTI-UNI2GR	4	60	Next Working Day
Universal 22,000	Red	RTV-UNI2RD	RTVMULTI-UNI2RD	4	60	Next Working Day
Universal 22,000	Black	RTV-UNI2BL	RTVMULTI-UNI2BL	4	60	Next Working Day

INVENTIVE

Roof ventilation solutions

SLATE VENTS

Available in single, multi and pallet quantities*
Multi = X vents in 1 box (order as each using multi code)

*Excludes 4001. Available in pack quantities only.



UNIVERSAL INLINE SLATE

bre



COMPATIBILITY

Natural or Synthetic slates from all major manufacturers in sizes:

- 300 x 600mm (WxH)
- 250 x 500mm (WxH)

USE

- On Natural or Synthetic Slate roofs
- For direct roof space ventilation
- Connected to a ducted ventilation system inside the building



22.5° min. pitch

9,450mm² free ventilation area

Replaces 1 slate

DESCRIPTION	COLOUR	SINGLE CODE	MULTI CODE	MULTI QUANTITY	PALLET QUANTITY	LEAD TIME
Inline Slate	Black	RTV-ISBL	RTVMULTI-ISBL	5	120	Next Working Day

SMALL INLINE SLATE

bre

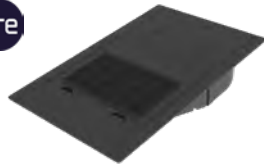

COMPATIBILITY

Natural or Synthetic slates from all major manufacturers in sizes:

- 400 x 250mm (WxH)
- 400 x 225mm (WxH)
- 400 x 200mm (WxH)
- 350 x 250mm (WxH)
- 350 x 200mm (WxH)
- 300 x 200mm (WxH)

USE

- On Natural or Synthetic Slate roofs
- For direct roof space ventilation
- Connected to a ducted ventilation system inside the building



22.5° min. pitch

9,450mm² free ventilation area

Replaces 1 slate

DESCRIPTION	COLOUR	SINGLE CODE	MULTI CODE	MULTI QUANTITY	PALLET QUANTITY	LEAD TIME
Small Inline	Black	RTV-SISBL	RTVMULTI-SISBL	5	120	Next Working Day

HOODED SLATE

bre



COMPATIBILITY

Natural or Synthetic slates from all major manufacturers in sizes:

- 300 x 600mm (WxH)
- 250 x 500mm (WxH)

USE

- On Natural or Synthetic Slate roofs
- For direct roof space ventilation
- Connected to a ducted ventilation system inside the building



22.5° min. pitch

22,000mm² free ventilation area

Replaces 1 slate

UV stabilised PP top

DESCRIPTION	COLOUR	SINGLE CODE	MULTI CODE	MULTI QUANTITY	PALLET QUANTITY	LEAD TIME
Hooded Slate	Black	RTV-HSBL	RTVMULTI-HSBL	4	68	Next Working Day

UNIVERSAL HOODED SLATE

bre



COMPATIBILITY

Natural or Synthetic slates from all major manufacturers in sizes:

- 300 x 600mm (WxH)
- 250 x 500mm (WxH)

USE

- On Natural or Synthetic Slate roofs
- For direct roof space ventilation
- Connected to a ducted ventilation system inside the building



22.5° min. pitch

10,000mm² free ventilation area

Replaces 1 slate

DESCRIPTION	COLOUR	SINGLE CODE	PACK QUANTITY	PALLET QUANTITY	LEAD TIME
Universal Hooded	Black	4001	5	120	Next Working Day

ADAPTERS & ACCESSORIES

Compatible accessories for connection to ventilation ducts or soil vent pipes.

10 YEAR
GUARANTEE

timac

EPD
AVAILABLE

STANDARD ADAPTER RTV-ADS

110mm connection for ventilation ducts or soil vent pipes



COMPATIBILITY

- CASTELLATED
- DOUBLE PANTILE
- DOUBLE ROMAN
- FLAT EDGE
- NON-PROFILE
- THIN LEADING EDGE

PLAIN ADAPTER RTV-ADP

110mm connection for ventilation ducts or soil vent pipes



COMPATIBILITY

- INTERLOCKING PLAIN
- PLAIN
- LOW PROFILE PLAIN
- SLIP PLAIN

INLINE SLATE ADAPTER RTV-ADIS

110mm connection for ventilation ducts or soil vent pipes

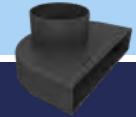

COMPATIBILITY

- INLINE SLATE
- SMALL INLINE SLATE

HOODED SLATE ADAPTER RTV-ADHS

110mm connection for ventilation ducts or soil vent pipes



COMPATIBILITY

- HOODED SLATE

MULTI STEPPED DUCT ADAPTER RTV-ADMULTI

Connection for various sizes of ventilation duct

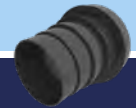

COMPATIBILITY

- STANDARD ADAPTER
- PLAIN ADAPTER
- INLINE SLATE ADAPTER
- 110MM FLEXI-PIPE

DESCRIPTION	PRODUCT CODE	BOX QUANTITY	LEAD TIME
Standard Tile Vent Adapter	RTV-ADS	12	Next Working Day
Plain Tile Vent Adapter	RTV-ADP	12	Next Working Day
Hooded Slate Vent Adapter	RTV-ADHS	10	Next Working Day
Inline Slate Vent Adapter	RTV-ADIS	10	Next Working Day
Multi Stepped Duct Adapter	RTV-ADMULTI	10	Next Working Day

Compatibility chart for the full range of accessories available in the InVentive tile and slate vent range.

Tile / Slate Vent Type		Compatible Accessory Options		
TILE / SLATE VENT	PRODUCT CODE	COMPATIBLE ACCESSORIES	PRODUCT CODE	PACK QUANTITY
Castellated	RTV-C	Standard Adapter	RTV-ADS	12
Double Pantile	RTV-DP	Multi Adapter	RTV-ADMULTI	10
Double Roman	RTV-DR			
Flat Edge	RTV-FE	Flexi-Pipe + Clamp	RTV-KIT1	1
Non-Profile	RTV-NP	Flexi-Pipe + Clamp + Standard Adapter	RTV-KIT2	1
Thin Leading Edge	RTV-TE			
Mini Castellated	RTV-MC	Multi Adapter	RTV-ADMULTI	10
Single Pantile	RTV-SP	Flexi-Pipe + Clamp	RTV-KIT1	1
Plain	RTV-P	Plain Adapter	RTV-ADP	12
Interlocking Plain	RTV-IP	Multi Adapter	RTV-ADMULTI	10
Low Profile Plain	RTV-LPP	Flexi-Pipe + Clamp	RTV-KIT1	1
Slip Plain	RTV-SLIP	Flexi-Pipe + Clamp + Plain Adapter	RTV-KIT3	1
Universal	RTV-UNI	Flexi-Pipe + Clamp	RTV-KIT1	1
Universal 22,000mm ²	RTV-UNI2			
Universal Inline Slate	RTV-IS	Inline Slate Adapter	RTV-ADIS	10
		Multi Adapter	RTV-ADMULTI	10
Small Inline Slate	RTV-SIS	Flexi-Pipe + Clamp	RTV-KIT1	1
		Flexi-Pipe + Clamp + Inline Slate Adapter	RTV-KIT4	1
Hooded Slate	RTV-HS	Hooded Slate Adapter	RTV-ADHS	10
		Flexi-Pipe + Clamp	RTV-KIT1	1
Universal Hooded Slate	4001	Pipe Adapter + Flexible PVC Pipe	4101	1
		Pipe Adapter only	4102	1
		Flexible PVC Pipe only	4103	1



FLEXI-PIPE KITS

To connect vents to 110mm ventilation duct or soil vent pipe

The 110mm Flexi-Pipe Kits are also compatible with the Multi Stepped Duct Adapter (RTV-ADMULTI)

<p>RTV-KIT1 FLEXI-PIPE ONLY</p>	<p>RTV-KIT2 with STANDARD ADAPTER</p>	<p>RTV-KIT3 with PLAIN ADAPTER</p>	<p>RTV-KIT4 with INLINE SLATE ADAPTER</p>
<p>KIT CONTAINS:</p> <ul style="list-style-type: none"> • 1 x Flexi-Pipe • 1 x Screw Clamp 	<p>KIT CONTAINS:</p> <ul style="list-style-type: none"> • 1 x Flexi-Pipe • 1 x Screw Clamp • 1 x Standard Adapter 	<p>KIT CONTAINS:</p> <ul style="list-style-type: none"> • 1 x Flexi-Pipe • 1 x Screw Clamp • 1 x Plain Adapter 	<p>KIT CONTAINS:</p> <ul style="list-style-type: none"> • 1 x Flexi-Pipe • 1 x Screw Clamp • 1 x Inline Slate Adapter
<p>COMPATIBLE WITH:</p> <ul style="list-style-type: none"> • RTV-MC • RTV-SP 	<p>COMPATIBLE WITH:</p> <ul style="list-style-type: none"> • RTV-C • RTV-DR • RTV-FE • RTV-NP 	<p>COMPATIBLE WITH:</p> <ul style="list-style-type: none"> • RTV-P • RTV-IP • RTV-LPP • RTV-SLIP 	<p>COMPATIBLE WITH:</p> <ul style="list-style-type: none"> • RTV-IS • RTV-SIS

DESCRIPTION	PRODUCT CODE	BOX QUANTITY	LEAD TIME
Flexi-Pipe + Clamp	RTV-KIT1	1	Next Working Day
Flexi-Pipe + RTV-ADS + Clamp	RTV-KIT2	1	Next Working Day
Flexi-Pipe + RTV-ADP + Clamp	RTV-KIT3	1	Next Working Day
Flexi-Pipe + RTV-ADIS + Clamp	RTV-KIT4	1	Next Working Day

INVENTIVE PRODUCT RANGE BREAKDOWN

Roof ventilation solutions Available Colours: ● Terracotta (TE) ● Brown (BR) ● Red (RD) ● Grey (GR) ● Black (BL)

Vent	Image	Compatibility	Min. Pitch°	Free Vent Area	Colours	Accessories	Code	Page
Castellated		FP McCann Square Top Lagan Square Top Marley Ludlow Major Redland Renown Russell Cheviot Sandtoft Lindum	20°	10,000mm ²	●●●●	RTV-ADS RTV-ADMULTI RTV-KITI	RTV-C	86
Double Pantile		Marley Mendip Quinn Locherne Redland Grovebury Redland Landmark Russell Pennine	20°	10,000mm ²	●●●●	RTV-ADS RTV-ADMULTI RTV-KITI	RTV-DP	86
Double Roman		FP McCann Double Roman Lagan Double Roll Marley Double Roman Redland 50 Double Roman Russell Double Roman Sandtoft Double Roman	20°	10,000mm ²	●●●●	RTV-ADS RTV-ADMULTI RTV-KITI	RTV-DR	86
Flat Edge		Sandtoft Calderdale Edge Sandtoft Danum	20°	10,000mm ²	●●●●●	RTV-ADS RTV-ADMULTI RTV-KITI	RTV-FE	87
Non-Profile		Lagan Flat Marley Duo Modern Marley Modern Redland Mini Stonewold Russell Grampian Russell Highland Sandtoft Calderdale	20°	10,000mm ²	●●●●●	RTV-ADS RTV-ADMULTI RTV-KITI	RTV-NP	87
Thin Leading Edge		Lagan Elite Marley Edgemere FP McCann Thin Flat Tile FP McCann Duo Thin Flat Tile Redland Richmond Russell Bute Russell Galloway Sandtoft TLE	20°	10,000mm ²	●●●●●	RTV-ADS RTV-ADMULTI RTV-KITI	RTV-TE	87
Mini Castellated		Forticrete V2 Marley Ludlow Plus Redland 49 Sandtoft Standard Pattern	17.5°	5,000mm ²	●●●●	RTV-ADMULTI RTV-KITI	RTV-MC	88
Single Pantile		Marley Anglia Redland Fenland Pantile Sandtoft Shire	20°	5,000mm ²	●●●●	RTV-ADMULTI RTV-KITI	RTV-SP	88
Interlocking Plain		Forticrete Gemini Marley Ashmore Redland Duoplan	22.5°	6,000mm ²	●●●●	RTV-ADP RTV-ADMULTI RTV-KITI	RTV-IP	88
Plain		Redland Rosemary Marley Plain Russell Traditional Plain Sandtoft Humber Plain	35°	7,000mm ²	●●●●	RTV-ADP RTV-ADMULTI RTV-KITI	RTV-P	89
Low Profile Plain		Redland Rosemary Marley Plain Russell Traditional Plain Sandtoft Humber Plain	35°	6,100mm ²	●●●●	RTV-ADP RTV-ADMULTI RTV-KITI	RTV-LPP	89
Slip Plain		Redland Rosemary Marley Plain Russell Traditional Plain Sandtoft Humber Plain	35°	6,100mm ²	●●●●	RTV-ADP RTV-ADMULTI RTV-KITI	RTV-SLIP	89
Universal		Customisable fit to a wide range of profiled and plain tiles using alternative flashing sheet	12.5°	20,000mm ² (170mm Ø) 16,000mm ² (150mm Ø) 11,000mm ² (125mm Ø) 8,400mm ² (110mm Ø)	●●●●●	RTV-KITI	RTV-UNI	90
Universal 22,000mm ²		Customisable fit to a wide range of profiled and plain tiles using alternative flashing sheet	12.5°	22,000mm ² (170mm Ø) 16,000mm ² (150mm Ø) 11,000mm ² (125mm Ø) 8,400mm ² (110mm Ø)	●●●●●	RTV-KITI	RTV-UNI2	90
Universal Inline Slate		600 x 300mm slates 500 x 250mm slates	22.5°	9,450mm ²	●	RTV-ADIS RTV-ADMULTI RTV-KITI	RTV-IS	91
Small Inline Slate		Small slates 300 x 200mm to 400 x 250mm	22.5°	9,450mm ²	●	RTV-ADIS RTV-ADMULTI RTV-KITI	RTV-SIS	91
Hooded Slate		600 x 300mm slates 500 x 250mm slates	22.5°	22,000mm ²	●	RTV-ADHS RTV-KITI	RTV-HS	91
Universal Hooded Slate		600 x 300mm slates 500 x 250mm slates	22.5°	10,000mm ²	●	4101 Pipe Adapter Kit	4001	91

M E T E R

B O X E S

by **timloc**

Gas, electric, surface mounted and **recessed** meter boxes.

ELECTRIC - RECESSED	96
ELECTRIC - SURFACE MOUNTED	96
ELECTRIC - 3 PHASE RECESSED	96
ELECTRIC - 3 PHASE MOUNTED	96
GAS - RECESSED	97
GAS - SURFACE MOUNTED	97
GAS - UNIVERSAL SMART	97
HOCKEY STICKS	97
REPLACEMENT PARTS	97



**SCAN TO VIEW
THE RANGE ONLINE**



ELECTRIC

Meter Boxes by Timloc are available for domestic use and are manufactured from hot-pressed, glass-reinforced plastic, making them hard-wearing and weather-resistant.



RECESSED

USE

- Designed to house UK standard domestic electric meters
- Recessed dimensions: 530 x 363 x 150mm

SURFACE MOUNTED

USE

- Designed to house UK standard domestic electric meters



3 PHASE RECESSED

USE

- Designed to house UK 3 phase electric meters

3 PHASE SURFACE MOUNTED

USE

- Designed to house UK 3 phase electric meters



DESCRIPTION	OVERALL DIMENSIONS	PRODUCT CODE	BOX QTY	PACK QTY	LEAD TIME
Electric Meter Box - Recessed	594 x 409 x 210mm	30011	1	N/A	Next Working Day
Electric Meter Box - Surface Mounted	595 x 410 x 220mm	30012	1	N/A	Next Working Day
Electric Meter Box 3 Phase - Recessed	794 x 565 x 180mm	30002	N/A	4	Next Working Day
Electric Meter Box 3 Phase - Surface Mounted	794 x 565 x 190mm	30003	N/A	2	Next Working Day

GAS



RECESSED

USE

- Designed to house UK standard domestic single phase gas meters
- Recessed dimensions: 530 x 363 x 150mm

SURFACE MOUNTED

USE

- Designed to house UK standard domestic single phase gas meters



UNIVERSAL SMART

USE

- Designed to house UK standard domestic smart gas meters

DESCRIPTION	DIMENSIONS	PRODUCT CODE	BOX QTY	LEAD TIME
Gas Meter Box - Recessed	595 x 409 x 214mm	30013	1	Next Working Day
Gas Meter Box - Surface Mounted	510 x 408 x 242mm	30015	1	Next Working Day
Gas Meter Box - Universal Smart	500 x 474 x 303mm	30017	1	Next Working Day

ACCESSORIES & SPARES

REPAIR KITS



SPARE DOORS



HOCKEY STICKS



DESCRIPTION	DIMENSIONS	PRODUCT CODE	PACK QTY	LEAD TIME
Internal Hockey Stick	1200 x 480 x 38mm	31001	1	NWD
Surface Mounted Hockey Stick	1450 x 310 x 38mm	31002	1	NWD
Replacement Door - Electric Meter Box - Recessed & Surface Mounted	549 x 383mm	30008	1	NWD
Replacement Door - Gas Meter Box - Recessed	549 x 383mm	30014	1	NWD
Replacement Door - Gas Meter Box - Surface Mounted	340 x 380mm	30016	1	NWD
Replacement Door - Universal Gas Meter Box	549 x 383mm	30018	1	NWD
Gas Meter Box Repair Kit	NA	30022	1	NWD
Electric Meter Box Repair Kit	NA	30027	1	NWD

HEDGEHOG HIGHWAY

by **timloc**

Helping **hedgehogs** roam
from garden to garden

Hedgehogs are classified as **vulnerable to extinction** and listed as a species of principal importance. The population of hedgehogs in Great Britain is estimated below 1 million, compared to over 30 million in the 1950s. **Loss of habitat** is one of the contributing factors in their reducing numbers.

The Hedgehog Highway by Timloc is designed to connect gardens, enabling hedgehogs to roam freely and forage for food and shelter without restriction.

Timloc Building Products has **donated over £4,000** so far to hedgehog charities and rescues across the UK from proceeds of the Hedgehog Highway.

Hedgehog Highway is manufactured using recycled plastic and packaging is 100% recyclable.



SCAN TO VISIT
THE WEBSITE



USE

- To frame fence holes designed to connect gardens, enabling hedgehogs to roam freely and forage for food and shelter without restriction

DIMENSIONS

- Product: 183mm (H) x 3mm (W) x 265mm (L)
- Hole: 130mm (H) x 130mm (L)

HEDGEHOG HIGHWAY

by **timloc**



PRODUCT CODE	COLOUR	PACK QUANTITY	LEAD TIME
5552	Black	2	Next Working Day
7772	Brown	2	Next Working Day
HOGBLACK	Black	60 (unboxed)	Next Working Day
HOGBROWN	Brown	60 (unboxed)	Next Working Day



MERCHANDISING

HELPING YOUR BRANCH TO BUILD ON SUCCESS

Designed to help you make the most of your space in-branch and showcase the Timloc products you have available to help maximise your sales.

To discuss your merchandising needs in further detail or to request assets, please get in touch with your area sale representative by scanning the QR code or via the details below:



Web: timloc.co.uk | Email: sales@timloc.co.uk | Phone: 01405 765 567

**3 x HEADER BOARD
OPTIONS TO PICK FROM**

**NEW
PACKAGING**

**BRANDED
SHELF STRIPS**



GUIDES

Whether you need comprehensive product information or condensed data on a specific category, we will have the guide to suit.

Scan the QR code for digital versions of the Timloc product guide, handbook, category guides and datasheets.

For print copies, please email: sales@timloc.co.uk



Compact **A5** guides packed with key information, codes and pack quantities.

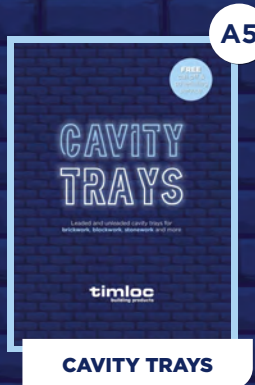

Sustainability Guide explains the steps we've taken towards sustainability.

Product Guide features detailed information, codes and pack quantities.



Timloc House, Ozone Park, Howden, East Yorkshire, DN14 7SD

T: 01405 765 567 **W:** www.timloc.co.uk

Sales: sales@timloc.co.uk

Technical: technical@timloc.co.uk

timloc

building products

2026 | Version 3

Every care has been taken to ensure that this brochure is correct at the time of printing, but Timloc Building Products does not accept responsibility for errors or misinterpretation of data. The customer should satisfy themselves that the products are suitable for their intended purpose. Following its policy of continuing product improvement, Timloc Building Products reserves the right to introduce changes to the specification and modifications of its design at any time without due notice. The customer should satisfy themselves by enquiring with Timloc Building Products if any changes have been introduced since its publication.