

PRODUCT GUIDE

NEW



timloc
building products

Sustainable building products
from ground level up to the roof ridge

We are a **British manufacturer** supplying the building industry for almost 60 years



At Timloc Building Products we manufacture and supply sustainable building products from ground level right up to the roof ridge, from our state-of-the-art manufacturing facility in East Yorkshire.

We are committed to sustainable manufacturing and over 75% of products are made from recycled plastics. Our products are designed for use throughout the lifespan of a building and are recyclable at the end of the building life.

GET SOCIAL

FIND US ON:



A promotional graphic featuring a white Timloc truck with a blue trailer driving on a road. The trailer has the 'timloc building products' logo. Overlaid on the image is a large blue banner that reads 'FREE NEXT DAY DELIVERY'. Below the banner is a location pin icon with the text 'on orders over £100 to branch or £150 to site'. At the bottom, there is a disclaimer: '*All orders placed before 12pm Monday - Friday will be delivered the next working day. Applicable to standard stock items only, please see individual product pages for more information.'

EQUALITY, DIVERSITY & INCLUSION

BUILDING A FAIRER FUTURE

We're committed to making the construction industry more inclusive, which is why we're part of the Construction Inclusion Coalition (CIC). The sector still lacks diversity and change requires real collaboration. Through the CIC's Built on Better Pledge, we're working to inspire future talent, share resources and help create a healthier, more welcoming industry for everyone.



The construction industry is vital to the UK's growth, yet it remains one of the least diverse sectors. With only 15% women (2% on-site), 6% ethnic minority representation, and 6% workers with disabilities, the industry risks missing out on a wealth of talent and perspective. We're proud to uphold a balanced gender split across all teams, including at management level, demonstrating our commitment to equality in practice.

SUSTAINABILITY

LEADING BY EXAMPLE



Scan the QR code to learn more

At Timloc Building Products, we take our responsibility for the environment very seriously and are committed to making positive steps to help reduce plastic waste within the building industry. In 2021, we became the first carbon neutral building products manufacturer in the UK.

Our products are designed for use throughout the lifespan of a home and are recyclable at the end of the building life. We have implemented a circular economy for the production and consumption of many Timloc products. This regenerative system means recycled materials are being used to make recyclable products.

Timloc Building Products is part of Alumasc Group Plc, a UK provider of sustainable building systems and solutions. Alumasc has been awarded the London Stock Exchange Green Economy Mark, recognising organisations generating over 50% of revenue from environmental solutions. **Together, we're shaping a greener future for the built environment.**



100% renewable electricity powering our operations



100% waste diverted from landfill



100% recyclable packaging



Over 75% of products manufactured using recycled materials

CONTENTS

CONSTRUCTION ACCESSORIES

Invisiweep	8
Invisiweep NC	8
Cavity Wall Weep	9
Drill Vent	9
Insulation Retaining Discs	9
1201 Telescopic Underfloor Ventilator	10
1201XL Telescopic Underfloor Ventilator	10
1201XL+ Telescopic Underfloor Ventilator	10
Telescopic Underfloor Ventilator Accessories	12
Airbricks	12

THROUGH-WALL VENTILATION

External Cowls	15
Cavity Sleeves	15
Adapt-Air	16
Aero Core	18
Internal Plastic Grilles	20
Internal Metal Grilles	20

CAVITY TRAYS

Everdry Adjustable Stepped - Brickwork	24
Everdry Stepped - Stonework	25
Everdry Stepped - Blockwork	26
Everdry Stepped - Brickwork - Lead Attached	27
Everdry Stepped - Stonework - Lead Attached	28
Everdry Stepped - Blockwork - Lead Attached	29
Inter-loc Horizontal	30
Inter-loc Horizontal - Lead Attached	31
System 2000 Horizontal	32
System 2000E Horizontal - Refurbishment	33
System 2000 Horizontal - Lead Attached	34
General Purpose Trays	35
Horizontal Parapet Trays	35
Lintel Trays	36
Threshold Trays	36
Door & Window Trays	37
Purpose Made Trays	37

TOP HATS, GAS BARRIERS & DPC

Top Hats	39
Flexible Top Hats	39
1201 Top Hat	39
Damp Proof Coursing	40
Radon Sump	41
Accessories	41

CAVITY CLOSERS & STOP SOCKS

Cavity Closers & Stop Socks Table	43
Thermo-loc Multi Cavity Closer	44
Thermo-loc + Cavity Closer	45
Thermo-loc + FX Cavity Closer	46
Thermo-loc FR30 Cavity Closer	47
Thermo-loc FR60 Cavity Closer	48
Thermo-loc FR60+ Cavity Closer	48
FRSTOP Stop Sock Masonry to Masonry	50
TIMFRSTOP Stop Sock Timber to Masonry	51
TTFRSTOP Stop Sock Timber to Timber	52
PWFRSTOP Party Wall Cavity Stop Sock Masonry to Masonry	53
PWTIMFRSTOP Party Wall Cavity Stop Sock Timber to Masonry	54

ACCESS PRODUCTS

Loftite Hinged Drop Down Loft Door	56
Plastic Push-up Loft Door	58
Plastic Hinged Drop Down Loft Door	58
Z-Series Metal 1 Hour Fire Rated Loft Door	59
Loft-loc Loft Door Poles	59
Plastic Access Panels	60
Airtight Plastic Access Panels	60
Z-Series Metal Access Panels	61
Metal 1 Hour Fire Rated Access Panels	61

RAD-SEAL

Rad-seal 10 Face-Fix Radiator Pipe Guide & Seal	63
Rad-seal 15 Face-Fix Radiator Pipe Guide & Seal	63
Rad-seal Recessed Radiator Pipe Guide & Seal	63

ROOFLINE

Push-In Soffit Vent	66
Soffit Vent Strip	66
2-in-1/3-in-1 Eaves Vent	67
Felt Support Tray	67
Eaves Bird Comb Filler	67
300mm Over Fascia Vent	68
1m Over Fascia Vent	68
Corbel Vent	68
Rafter Roll	69
6m Eaves Vent Pack	69
Lap Vent	70
PbFree Lead-free Flashing	71
6m 10m Dry Fix Ridge Kit	72
3m 6m Integrated Dry Ridge Kit	73
Dry Fix Clay Ridge Kit	73
Dry Fix Hip Kit	74
Hip Tray Pack	74
Hip Clips Kit	74
Universal Caps & Brackets - Dry Fix Verge	75

ROOFLINE CONTINUED

Ambi-verge Universal Dry Fix Verge System	75
Handed Dry Fix Verge System	76
Interlocking Plain Edge Dry Verge	76
Thin Leading Edge Dry Verge	77
Dry Fix Continuous Verge System	77
Ambi-Soakers - Plain	79
Ambi-Soakers - Interlocking Plain	79
Ambi-Soakers - Slate	79
Ambi-Soakers - Thin Leading Edge	79
Ambi-Soakers - Flat	79

INVENTIVE ROOF TILE & SLATE VENTS

Inventive Compatibility Chart	82
Castellated Tile Vent	84
Double Pantile Tile Vent	84
Double Roman Tile Vent	84
Flat Edge Tile Vent	85
Non-Profile Tile Vent	85
Thin Leading Edge Tile Vent	85
Mini Castellated Tile Vent	86
Single Pantile Tile Vent	86
Interlocking Plain Tile Vent	86
Plain Tile Vent	87
Low-Profile Plain Tile Vent	87
Slip Plain Tile Vent	87
Universal Tile Vent	88
Universal 22,000 Tile Vent	88
Universal Inline Slate Tile Vent	89
Small Inline Slate Tile Vent	89
Hooded Slate Tile Vent	89
Universal Hooded Slate Tile Vent	89
Standard Roof Tile Vent Adapter	90
Plain Roof Tile Vent Adapter	90
Inline Slate Vent Adapter	90
Hooded Slate Vent Adapter	90
Multi Stepped Duct Adapter	90
110mm Flexi-Pipe Kits	91
Inventive Breakdown Table	92

METER BOXES

Electric - Recessed	94
Electric - Surface Mounted	94
Electric 3 Phase - Recessed	94
Electric 3 Phase - Surface Mounted	94
Gas - Recessed	95
Gas - Surface Mounted	95
Gas - Universal Smart	95
Hockey Sticks	95
Replacement Parts	95

HEDGEHOG HIGHWAY

Hedgehog Highway	97
------------------	----

Visit the Timloc website for further information including:

DATASHEETS | INSTALLATION ADVICE
COMMODITY CODES | CERTIFICATIONS

**SCAN TO VIEW
ONLINE**



ENVIRONMENTAL PRODUCT DECLARATION

INDEPENDENTLY VERIFIED AND PUBLISHED EPD

An Environmental Product Declaration (EPD) is an independently verified document that tracks and quantifies a product's environmental impact through every stage of its lifecycle. From raw materials to manufacturing, installation and end-of-life, an EPD provides clear, comparable data that helps designers, specifiers, and customers make confident, sustainability-led choices.

Look for the **EPD icon** to identify products with an EPD.



DID YOU KNOW?

Over 80% of Timloc Building Products have EPDs.

Scan the QR code to request access to our EPD documents.



CONSTRUCTION ACCESSORIES

INVISIWEEP	8
INVISIWEEP NC	8
CAVITY WALL WEEP	9
DRILL VENT	9
INSULATION RETAINING DISCS	9
TELESCOPIC UNDERFLOOR VENTS	10
TELESCOPIC UNDERFLOOR VENT ACCESSORIES	12
AIRBRICKS	12

SCAN TO VIEW
THE RANGE ONLINE



WALL WEEPS

INVISIWEEP

The almost invisible wall weep



USE

- Low-profile wall weep for discharging water from external walls
- Suitable for external wall depths of 102.5mm
- 500mm extension tube available to accommodate deeper walls

DIMENSIONS

- 65mm (H) x 10mm (W) x 102mm (L) extension available to accommodate deeper walls

IW500EX provides up to a **500mm extension** and can be cut to size. Slots directly into the front of the Invisiweep.

PRODUCT CODE	COLOUR	PACK QTY	LEAD TIME
IW500EX	Clear	10	Next Working Day



Scan to view product video

COLOUR	50 QTY CODE	200 QTY CODE	LEAD TIME
Black	IW50BL	IW200BL	Next Working Day
Blue Black	IW50BB	IW200BB	Next Working Day
Brown	IW50BR	IW200BR	Next Working Day
Buff	IW50BU	IW200BU	Next Working Day
Clear	IW50CL	IW200CL	Next Working Day
Grey	IW50GR	IW200GR	Next Working Day
Terracotta	IW50TE	IW200TE	Next Working Day
White	IW50WH	IW200WH	Next Working Day

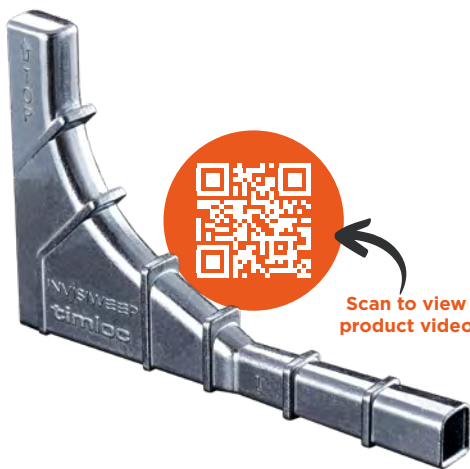

Scan to view product video

PRODUCT CODE	PACK QTY	LEAD TIME
ZIN50	50	Next Working Day

INVISIWEEP

The non-combustible wall weep

USE

- In external masonry walls
- When a building storey is above 18 metres from ground level, non-combustible materials must be used
- When a building storey is above 11 metres from ground level, non-combustible materials must be used (Scotland)
- At ground floor slab level
- Within cavity tray systems
- Over external lintels

DIMENSIONS

- 65mm (H) x 10mm (W) x 102mm (L)

CAVITY WALL WEEP



USE

- Multi-function cavity wall weep designed for cavity ventilation and reliable discharge of water from inside cavity walls
- Where a cavity must be ventilated
- Where a cavity tray system is installed
- Over external lintels
- At ground floor slab level
- On external brick, block or stone walls of 100mm+ thickness

DIMENSIONS

- 65mm (H) x 10mm (W) x 100mm (L)

COLOUR	PACK QTY	PRODUCT CODE	LEAD TIME
Black	50	1143BL	Next Working Day
Blue Black	50	1143BB	Next Working Day
Brown	50	1143BR	Next Working Day
Buff	50	1143BU	Next Working Day
Clear	50	1143CL	Next Working Day
Grey	50	1143GR	Next Working Day
Terracotta	50	1143TE	Next Working Day
White	50	1143WH	Next Working Day



The 1144 offers a **50mm extension** and connects directly to the 1143 cavity wall weep.

PRODUCT CODE	COLOUR	PACK QTY	LEAD TIME
1144	Clear	50	Next Working Day



DRILL VENT

USE

- Retrospective cavity wall weep
- Ideal for venting timber framed buildings
- Both high and low-level ventilation and drainage to an external cavity system

DIMENSIONS

- 40mm (H) x 25mm (D) x 80mm (L)

COLOUR	PACK QTY	PRODUCT CODE	LEAD TIME
Clear	50	DV1	Next Working Day
Buff	50	DV2	Next Working Day
Terracotta	50	DV3	Next Working Day

INSULATION RETAINING DISCS

USE

- To suit most styles and sizes of wall ties and applications
- 80mm and 65mm diameter options

COLOUR	DIAMETER	PACK QTY	PRODUCT CODE	LEAD TIME
Black	65mm	1500	IRD65BL	Next Working Day
Red	80mm	1000	IRD80R	Next Working Day



TELESCOPIC UNDERFLOOR VENTS

Adjustable telescopic underfloor vent range designed to provide ventilation beneath suspended ground floors of varying coursing heights.



1201



- Adjustable for 3-5 brick courses
- 50-100mm cavity width construction
- Free area of 8,000mm² without airbrick
- Free area of 6,500mm² with airbrick
- Comes with vermin grille

1201XL

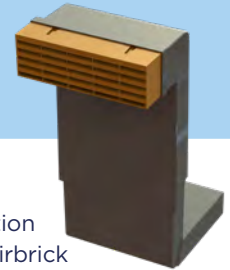

- Adjustable for 5-7 brick courses
- 50-150mm cavity width construction
- Free area of 8,000mm² without airbrick
- Free area of 6,500mm² with airbrick
- Comes with vermin grille

1201XL+



- Adjustable for 5-7 brick courses
- 50-150mm+ cavity width construction
- Free area of 8,000mm² without airbrick
- Free area of 6,500mm² with airbrick

PRODUCT CODE	PACK QTY	HEIGHT	LEAD TIME
1201	20	3-5 Courses	Next Working Day
1201XL	10	5-7 Courses	Next Working Day
1201XLPLUS	10	5-7 Courses	Next Working Day

DIMENSION DRAWINGS

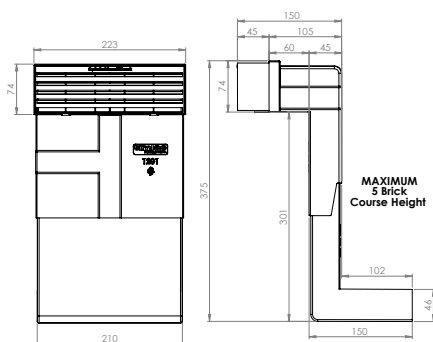

1201 DIMENSIONS

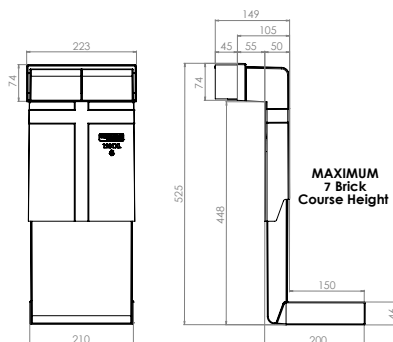

1201XL DIMENSIONS

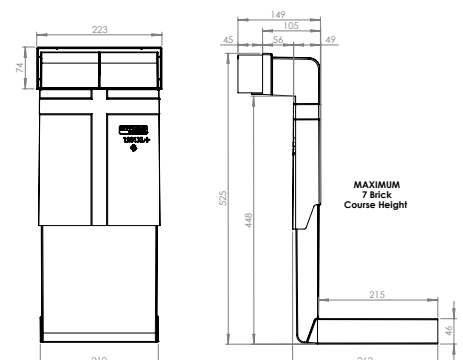

1201XL+ DIMENSIONS

AND ACCESSORIES

Adapt the **1201**, **1201XL** and **1201XL+** units to suit various applications including horizontal and vertical extensions and ducting adaption, without restricting airflow.

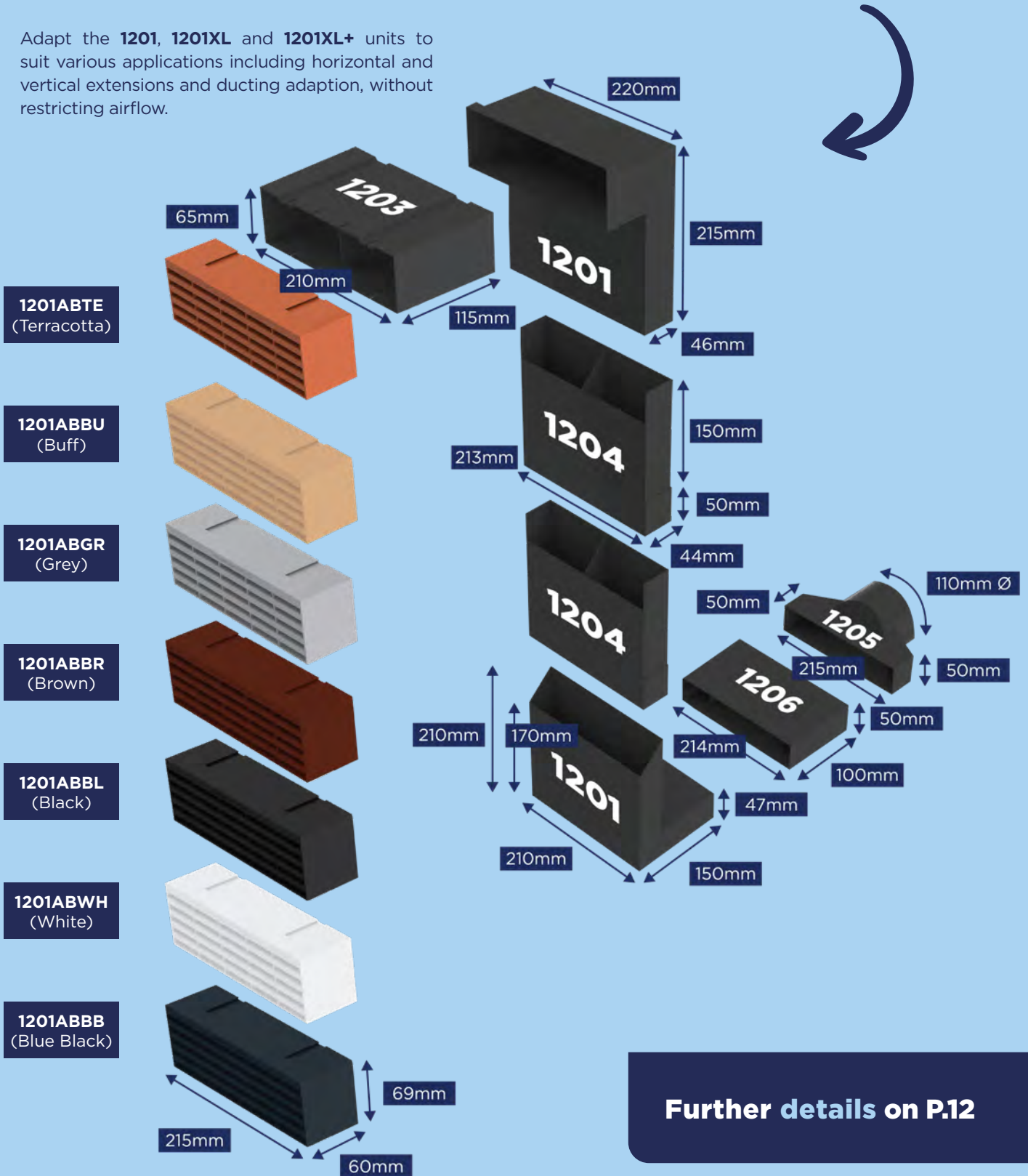

Further details on P.12

TELESCOPIC UNDERFLOOR VENTS

ACCESSORIES

Designed for use with telescopic underfloor vents, these easy-to-fit accessories provide flexible horizontal or vertical extensions to accommodate varying wall, cavity, or brick courses. Multiple units can be combined to achieve greater depths and heights, or used to connect the ventilator directly to a duct.



1203

HORIZONTAL FRONT EXTENSION

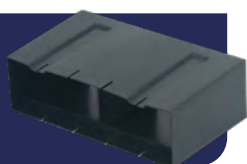

- Provides +115mm horizontal extension
- Fits between airbrick & upper front of vent
- Accommodates external walls more than 102.5mm thickness, up to a maximum of 215mm

1204

VERTICAL EXTENSION



- Provides +150mm vertical extension
- Fits between upper & lower parts of vent
- Multiple units can be added to achieve greater heights

1205

DUCT ADAPTER

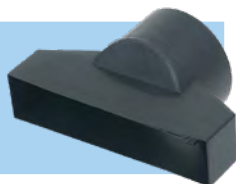

- Enables connection to 110mm Ø plastic drainage pipe
- Fits to lower rear of vent
- To be connected via a coupling connection

1206

HORIZONTAL REAR EXTENSION

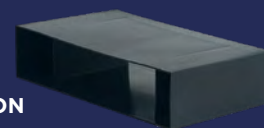

- Provides +100mm horizontal extension
- Fits to lower rear of vent
- Accommodates cavity widths between 50-150mm
- Accommodates internal walls of 100-200mm thickness

PRODUCT CODE	DESCRIPTION	DIMENSIONS	PACK QTY	LEAD TIME
1203	Horizontal Front Extension	65mm (H) x 115mm (W) x 210mm (L)	20	Next Working Day
1204	Vertical Extension	200mm (H) x 44mm (W) x 213mm (L)	20	Next Working Day
1205	Duct Adapter 110mm Ø	50mm (H) x 50mm (W) x 215mm (L)	1	Next Working Day
1206	Horizontal Rear Extension	50mm (H) x 100mm (W) x 214mm (L)	20	Next Working Day

AIRBRICKS



COLOUR	PACK QTY	PRODUCT CODE	LEAD TIME
Black	20	1201ABBL	Next Working Day
Blue Black	20	1201ABBB	Next Working Day
Brown	20	1201ABBR	Next Working Day
Buff	20	1201ABBU	Next Working Day
Grey	20	1201ABGR	Next Working Day
Terracotta	20	1201ABTE	Next Working Day
White	20	1201ABWH	Next Working Day

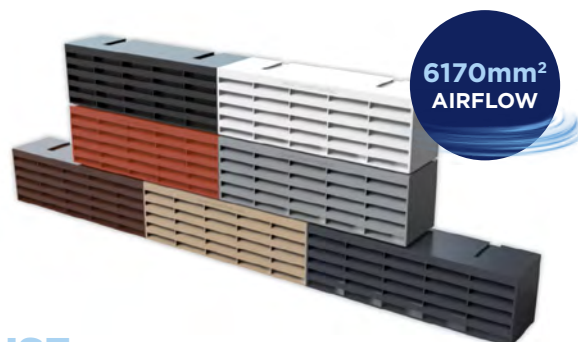

USE

- Robust plastic airbrick for use with cavity sleeves and telescopic underfloor vents
- Integral clips enable multiple airbricks to be stacked together

timloc

building products

MANUFACTURING TO THE HIGHEST STANDARDS.

Setting the standard on certification and quality with extensive 3rd party testing and compliance.



THROUGH WALL VENTILATION

EXTERNAL COWLS	15
CAVITY SLEEVES	15
ADAPT-AIR	16
AERO CORE	18
INTERNAL PLASTIC GRILLES	20
INTERNAL METAL GRILLES	20

SCAN TO VIEW
THE RANGE ONLINE



EXTERNAL COWLS

USE

- To provide an external cowl over the airbrick to help reduce draughts caused by wind blasts



PRODUCT CODE	DESCRIPTION	COLOUR	OVERALL DIMENSIONS	EQUIVALENT AREA	PACK QTY	LEAD TIME
ABC93TE	9 x 3 external cowl	Terracotta	255mm x 96mm	8,700mm ²	1	Next Working Day
ABC93BR	9 x 3 external cowl	Brown	255mm x 96mm	8,700mm ²	1	Next Working Day
ABC96TE	9 x 6 external cowl	Terracotta	255mm x 154mm	16,000mm ²	1	Next Working Day
ABC96BR	9 x 6 external cowl	Brown	255mm x 154mm	16,000mm ²	1	Next Working Day
ABC99TE	9 x 9 external cowl	Terracotta	274mm x 235mm	23,900mm ²	1	Next Working Day
ABC99BR	9 x 9 external cowl	Brown	274mm x 235mm	23,900mm ²	1	Next Working Day



1202/1



1202/2

CAVITY SLEEVES

USE

- Cavity sleeves, baffle and extension accessories to provide ventilation through external walls to the building interior

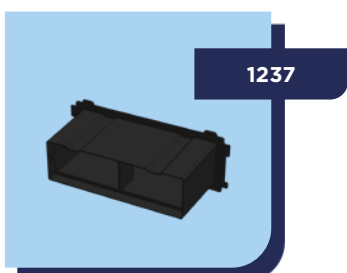

1237

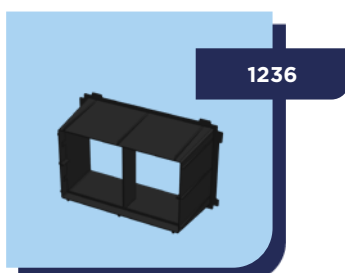

1236

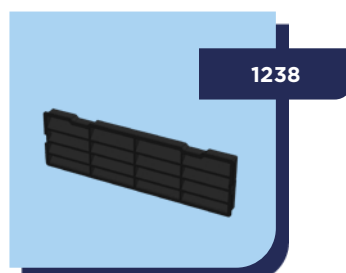

1238



PRODUCT CODE	DESCRIPTION	TO SUIT	PACK QTY	LEAD TIME
1202/1	9 x 3 cavity sleeve	Single airbrick	20	Next Working Day
1202/2	9 x 6 cavity sleeve	2 x stacked airbricks	1	Next Working Day
1237	9 x 3 telescopic extension	+90mm	1	Next Working Day
1236	9 x 6 telescopic extension	+90mm	1	Next Working Day
1238	9 x 3 baffle	Single airbrick	1	Next Working Day



Adapt-Air

Pre-assembled **ducting to airbrick adapter** designed to be built in as part of the brickwork package.



SAVES TIME

build in as part of brickwork package



HELPS TO MEET

Building Regulation Part F



SAFER INSTALLATION

no need for core drilling



COST SAVING

no need for external fitters



CHOICE

of 7 different airbrick colours



PRE-ASSEMBLED

ready to install





Adapt-Air has been designed to be built in as part of the brickwork package and terminates at an external airbrick, removing the need to use unsightly gravity flap vents and avoiding the unsightly re-works of cutting a hole through brickwork.

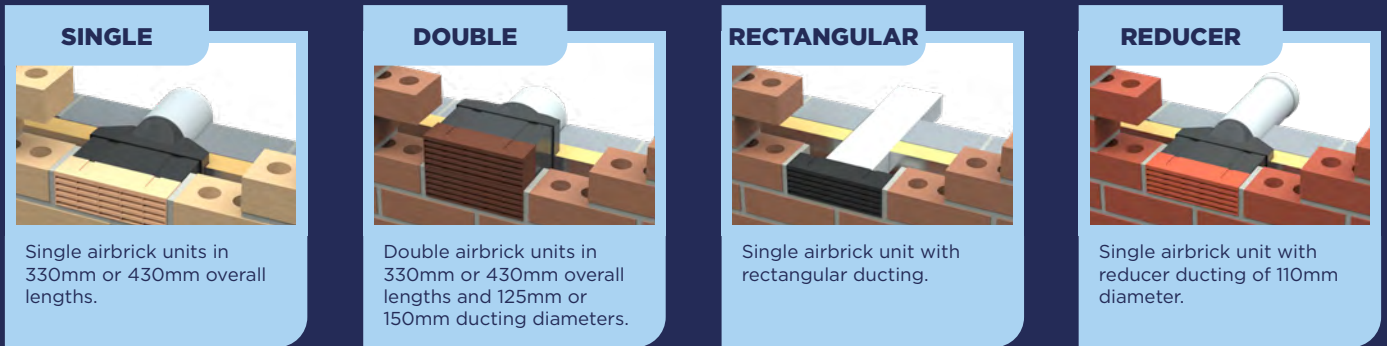

Use the chart below to establish the Adapt-Air model to suit your specification

	6500	6520	3511	6510	6512	6525	6515	6550
SINGLE OR DOUBLE AIRBRICK	SINGLE	SINGLE	SINGLE	SINGLE	DOUBLE	DOUBLE	DOUBLE	DOUBLE
DUCT SIZE	100MM Ø	100MM Ø	110MM Ø	100MM X54MM	125MM Ø	125MM Ø	150MM Ø	150MM Ø
OVERALL LENGTH	330MM	430MM	450MM	450MM	330MM	430MM	330MM	430MM
DUCTING SHAPE								
SUITED FOR	BATHROOM, WC, UTILITY OR KITCHEN	BATHROOM, WC, UTILITY OR KITCHEN	BATHROOM, WC, UTILITY OR KITCHEN	BATHROOM, WC, UTILITY OR KITCHEN	BATHROOM, WC, UTILITY OR KITCHEN	BATHROOM, WC, UTILITY OR KITCHEN	BATHROOM, WC, UTILITY OR KITCHEN	BATHROOM, WC, UTILITY OR KITCHEN
REDUCER								
SUITED CAVITY SIZE	UP TO 100MM	UP TO 150MM	UP TO 150MM	UP TO 150MM	UP TO 100MM	UP TO 150MM	UP TO 100MM	UP TO 150MM

DESCRIPTION	DUCT SIZE	OVERALL LENGTH	PRODUCT CODE	PACK QTY	LEAD TIME
Adapt-Air Single Airbrick 330mm x 100mm	100mm Ø	330mm	6500 + colour	1	Next Working Day
Adapt-Air Single Airbrick 430mm x 100mm	100mm Ø	430mm	6520 + colour	1	Next Working Day
Adapt-Air Single Airbrick 450mm x 100mm	110mm Ø	450mm	3511 + colour	1	Next Working Day
Adapt-Air Single Airbrick Rectangular 450mm x 100mm x 54mm	100mm x 54mm	450mm	6510 + colour	1	Next Working Day
Adapt-Air Double Airbrick 330mm x 125mm	125mm Ø	330mm	6512 + colour	1	Next Working Day
Adapt-Air Double Airbrick 430mm x 125mm	125mm Ø	430mm	6525 + colour	1	Next Working Day
Adapt-Air Double Airbrick 330mm x 150mm	150mm Ø	330mm	6515 + colour	1	Next Working Day
Adapt-Air Double Airbrick 430mm x 150mm	150mm Ø	430mm	6550 + colour	1	Next Working Day

State required colour at the end of the product code: Terracotta: **TE**, Buff: **BU**, Grey: **GR**, Brown: **BR**, Black: **BL**, White: **WH**

ANTI-DRAUGHT VENTILATORS

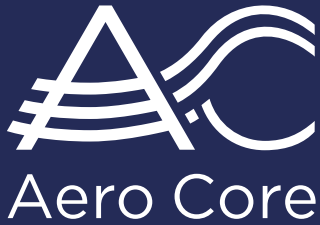

Combination ventilator sets for background venting and heat producing appliances. Aesthetically pleasing and simple to install system that is ideal for refurbishment, remedial work, and new build projects.

Available in fixed and adjustable formats and various external colour finishes.



GRILLE



FIXED



ADJUSTABLE

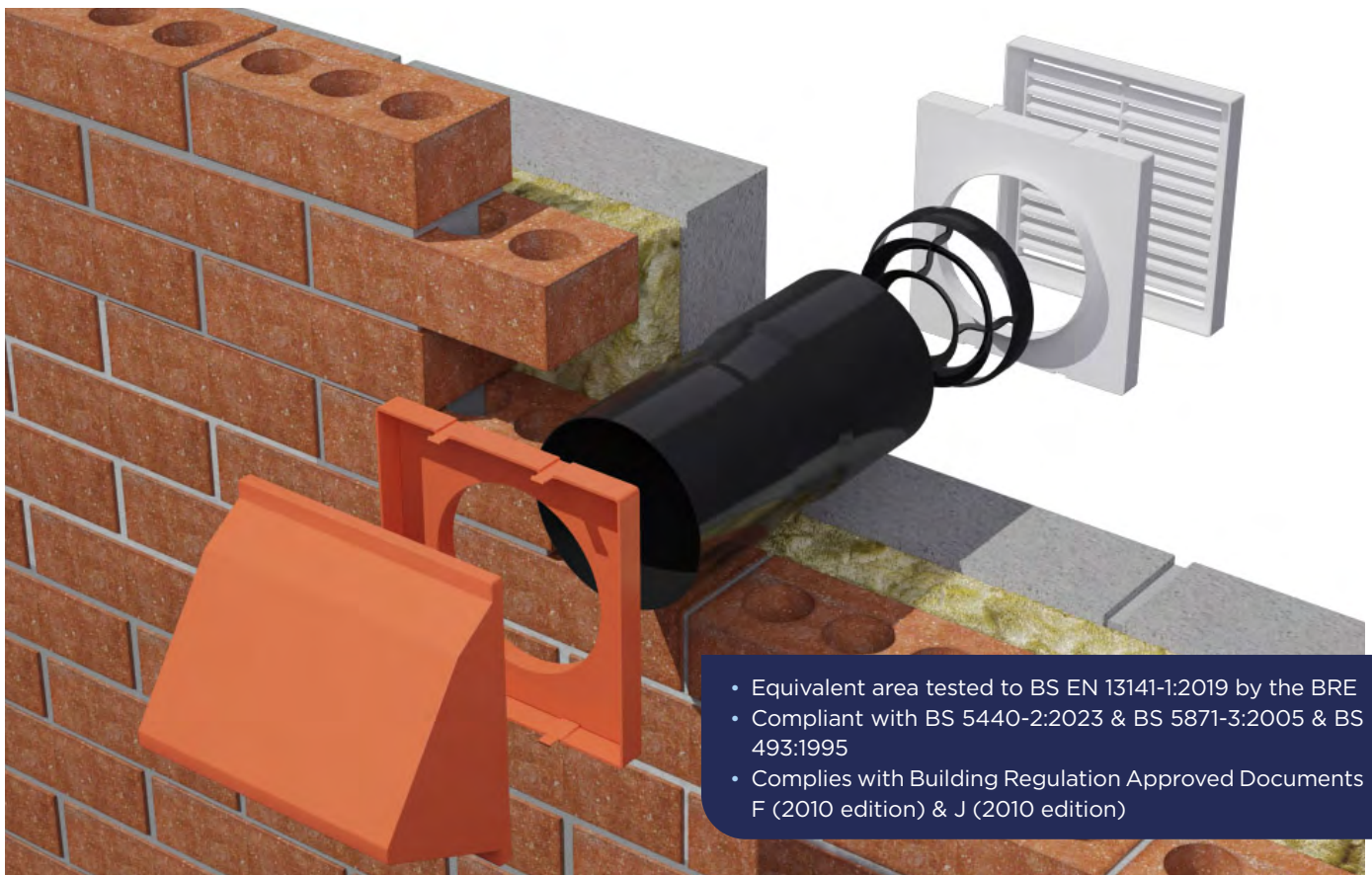

- Equivalent area tested to BS EN 13141-1:2019 by the BRE
- Compliant with BS 5440-2:2023 & BS 5871-3:2005 & BS 493:1995
- Complies with Building Regulation Approved Documents F (2010 edition) & J (2010 edition)

FIXED VENT

DESCRIPTION	EQUIVALENT AREA	APPLIANCE RATED INPUT	EXTERNAL	COLOUR	PACK QTY	PRODUCT CODE	LEAD TIME
5" (127mm) Aero Core Fixed Vent - Baffle	8,000mm ²	23kW (78,500 Btu)	Grille	Terracotta	1	7500TE	Next Working Day
5" (127mm) Aero Core Fixed Vent - Baffle	8,000mm ²	23kW (78,500 Btu)	Grille	Brown	1	7500BR	Next Working Day
5" (127mm) Aero Core Fixed Vent - Baffle	8,000mm ²	23kW (78,500 Btu)	Grille	Buff	1	7500BU	Next Working Day
5" (127mm) Aero Core Fixed Vent - Baffle	8,000mm ²	23kW (78,500 Btu)	Grille	White	1	7500WH	Next Working Day
5" (127mm) Aero Core Fixed Vent - Baffle	8,000mm ²	23kW (78,500 Btu)	Cowl	Terracotta	1	7510TE	Next Working Day
5" (127mm) Aero Core Fixed Vent - Baffle	8,000mm ²	23kW (78,500 Btu)	Cowl	Brown	1	7510BR	Next Working Day
5" (127mm) Aero Core Fixed Vent - Baffle	8,000mm ²	23kW (78,500 Btu)	Cowl	Buff	1	7510BU	Next Working Day
5" (127mm) Aero Core Fixed Vent - Baffle	8,000mm ²	23kW (78,500 Btu)	Cowl	White	1	7510WH	Next Working Day

ADJUSTABLE VENT

DESCRIPTION	EQUIVALENT AREA	APPLIANCE RATED INPUT	EXTERNAL	COLOUR	PACK QTY	PRODUCT CODE	LEAD TIME
5" (127mm) Aero Core Adjustable Vent - Baffle	Up to 8,000mm ²	NA	Grille	Terracotta	1	7520TE	Next Working Day
5" (127mm) Aero Core Adjustable Vent - Baffle	Up to 8,000mm ²	NA	Grille	Brown	1	7520BR	Next Working Day
5" (127mm) Aero Core Adjustable Vent - Baffle	Up to 8,000mm ²	NA	Grille	Buff	1	7520BU	Next Working Day
5" (127mm) Aero Core Adjustable Vent - Baffle	Up to 8,000mm ²	NA	Grille	White	1	7520WH	Next Working Day
5" (127mm) Aero Core Adjustable Vent - Baffle	Up to 8,000mm ²	NA	Cowl	Terracotta	1	7530TE	Next Working Day
5" (127mm) Aero Core Adjustable Vent - Baffle	Up to 8,000mm ²	NA	Cowl	Brown	1	7530BR	Next Working Day
5" (127mm) Aero Core Adjustable Vent - Baffle	Up to 8,000mm ²	NA	Cowl	Buff	1	7530BU	Next Working Day
5" (127mm) Aero Core Adjustable Vent - Baffle	Up to 8,000mm ²	NA	Cowl	White	1	7530WH	Next Working Day

GRILLE VENT

DESCRIPTION	EQUIVALENT AREA	APPLIANCE RATED INPUT	EXTERNAL	COLOUR	PACK QTY	PRODUCT CODE	LEAD TIME
5" (127mm) Aero Core Grille Vent - Baffle	8,000mm ²	23kW (78,500 Btu)	Grille	Terracotta	1	ACV7TE	Next Working Day
5" (127mm) Aero Core Grille Vent - Baffle	8,000mm ²	23kW (78,500 Btu)	Grille	Brown	1	ACV7BR	Next Working Day
5" (127mm) Aero Core Grille Vent - Baffle	8,900mm ²	24.8kW (84,600 Btu)	Cowl	Terracotta	1	ACV7CTE	Next Working Day
5" (127mm) Aero Core Grille Vent - Baffle	8,900mm ²	24.8kW (84,600 Btu)	Cowl	Brown	1	ACV7CBR	Next Working Day

ACCESSORIES

DESCRIPTION	COLOUR	PACK QTY	PRODUCT CODE	LEAD TIME
Aero Core Backplate Accessory	White	1	25159	Next Working Day
Aero Core Tube Accessory	Black	1	ACTUBE	Next Working Day
Aero Core Connector Accessory	White	1	6532	Next Working Day

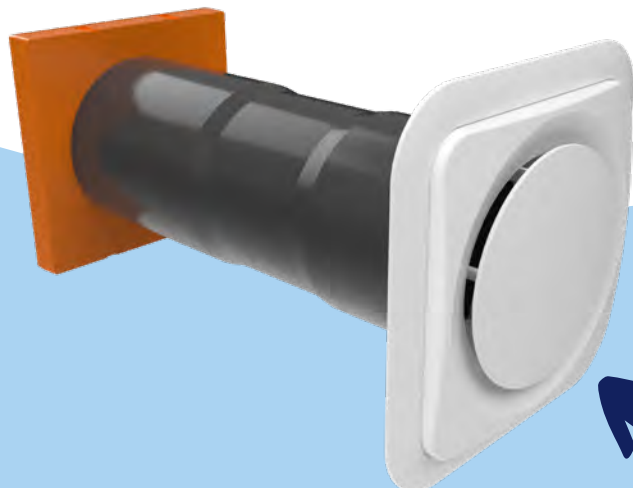

PERFORMANCE
AT ITS CORE

NEED SOMETHING
EXTRA?

Optional backplate accessory designed to cover chipped areas of internal wall during installation and after core drilling (not compatible with internal grille options).

INTERNAL PLASTIC GRILLES



USE

- To cover the inner opening on the cavity sleeve and provide a neater appearance while still maintaining a free flow of air

PRODUCT CODE	DESCRIPTION	COLOUR	OVERALL DIMENSIONS	EQUIVALENT AREA	PACK QTY	LEAD TIME
1207W	9 x 3 louvre vent	White	260mm x 194mm	7,600mm ²	1	Next Working Day
1211W	9 x 6 louvre vent	White	260mm x 170mm	11,300mm ²	1	Next Working Day
1212W	9 x 9 louvre vent	White	260mm x 235mm	16,500mm ²	1	Next Working Day
1207WF	9 x 3 louvre vent with flyscreen	White	260mm x 104mm	3,750mm ²	1	Next Working Day
1211WF	9 x 6 louvre vent with flyscreen	White	260mm x 170mm	7,150mm ²	1	Next Working Day
1212WF	9 x 9 louvre vent with flyscreen	White	260mm x 235mm	8,190mm ²	1	Next Working Day
1208W	9 x 3 hit & miss louvre vent	White	260mm x 104mm	3,750mm ²	1	Next Working Day
1209W	9 x 6 hit & miss louvre vent	White	260mm x 170mm	7,150mm ²	1	Next Working Day
1210W	9 x 9 hit & miss louvre vent	White	260mm x 235mm	8,190mm ²	1	Next Working Day



INTERNAL METAL GRILLES

USE

- To cover the inner opening on the cavity sleeve and provide a neater appearance while still maintaining a free flow of air



PLAIN ALUMINIUM

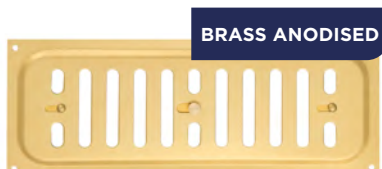

BRASS ANODISED



POLISHED BRASS

PRODUCT CODE	DESCRIPTION	COLOUR	OVERALL DIMENSIONS	EQUIVALENT AREA	PACK QTY	LEAD TIME
1220A	9 x 3 hit & miss vent	Plain aluminium	242mm x 89mm	3,741mm ²	1	Next Working Day
1220BA	9 x 3 hit & miss vent	Brass anodised	242mm x 89mm	3,741mm ²	1	Next Working Day
1220PB	9 x 3 hit & miss vent	Polished brass	242mm x 89mm	3,741mm ²	1	Next Working Day
1221A	9 x 6 hit & miss vent	Plain aluminium	242mm x 165mm	6,452mm ²	1	Next Working Day
1221BA	9 x 6 hit & miss vent	Brass anodised	242mm x 165mm	6,452mm ²	1	Next Working Day
1221PB	9 x 6 hit & miss vent	Polished brass	242mm x 165mm	6,452mm ²	1	Next Working Day
1222A	9 x 9 hit & miss vent	Plain aluminium	242mm x 242mm	11,250mm ²	1	Next Working Day
1222BA	9 x 9 hit & miss vent	Brass anodised	242mm x 242mm	11,250mm ²	1	Next Working Day
1222PB	9 x 9 hit & miss vent	Polished brass	242mm x 242mm	11,250mm ²	1	Next Working Day
1223A	9 x 3 louvre vent	Plain aluminium	242mm x 89mm	3,973mm ²	1	Next Working Day
1223BA	9 x 3 louvre vent	Brass anodised	242mm x 89mm	3,973mm ²	1	Next Working Day
1223PB	9 x 3 louvre vent	Polished brass	242mm x 89mm	3,973mm ²	1	Next Working Day
1224A	9 x 6 louvre vent	Plain aluminium	242mm x 165mm	7,946mm ²	1	Next Working Day
1224BA	9 x 6 louvre vent	Brass anodised	242mm x 165mm	7,946mm ²	1	Next Working Day
1224PB	9 x 6 louvre vent	Polished brass	242mm x 165mm	7,946mm ²	1	Next Working Day
1225A	9 x 9 louvre vent	Plain aluminium	242mm x 242mm	12,770mm ²	1	Next Working Day
1225BA	9 x 9 louvre vent	Brass anodised	242mm x 242mm	12,770mm ²	1	Next Working Day
1225PB	9 x 9 louvre vent	Polished brass	242mm x 242mm	12,770mm ²	1	Next Working Day
1226A	25.2 x 2 return air grille	Plain aluminium	648mm x 60mm	9,774mm ²	1	Next Working Day
1226BA	25.2 x 2 return air grille	Brass anodised	648mm x 60mm	9,774mm ²	1	Next Working Day

CAVITY TRAYS

EVERDRY STEPPED - BRICKWORK	24
EVERDRY STEPPED - STONWORK	25
EVERDRY STEPPED - BLOCKWORK	26
EVERDRY STEPPED - BRICKWORK - LEADED	27
EVERDRY STEPPED - STONWORK - LEADED	28
EVERDRY STEPPED - BLOCKWORK - LEADED	29
INTER-LOC HORIZONTAL	30
INTER-LOC HORIZONTAL - LEADED	31
SYSTEM 2000 HORIZONTAL	32
SYSTEM 2000E HORIZONTAL - REFURBISHMENT	33
SYSTEM 2000 HORIZONTAL - LEADED	34
GENERAL PURPOSE TRAYS	35
HORIZONTAL PARAPET TRAYS	35
LINTEL TRAYS	36
THRESHOLD TRAYS	36
DOOR & WINDOW TRAYS	37
PURPOSE MADE TRAYS	37



**SCAN TO VIEW
THE RANGE ONLINE**



CAVITY TRAYS



Use the table below to establish which Timloc cavity tray is best suited to your project specification. If you require any further assistance please contact Technical via the details below: Phone: **01405 782 769** | Email: technical@timloc.co.uk

CAVITY TRAY → APPLICATION ↓	EVERDRY	INTER-LOC	SYSTEM 2000	SYSTEM 2000E	OVER LINTEL	GENERAL PURPOSE	PARAPET HORIZONTAL	PURPOSE MADE	DOOR & WINDOW	LINTEL STOPEND
PITCHED ROOF	✓									
FLAT ROOF		✓	✓	✓						
LEAN-TO		✓	✓	✓						
MONO-PITCH		✓	✓	✓						
CONCRETE RING BEAMS		✓	✓			✓				
AIRBRICKS, DUCTS, LINERS, METER BOXES ETC.		✓	✓	✓		✓				
EXISTING WALLS (REMEDIAL WORK)		✓		✓						
STEEL LINTELS					✓					✓
PARAPET WALLS							✓			
DPC APPLICATIONS								✓		
DOOR & WINDOW ARCHES									✓	
CIRCULAR WINDOWS									✓	
LEADED OPTIONS	✓	✓	✓							

Timloc Building Products offers a wide range of preformed cavity trays to meet almost any application requirement and type of masonry. Here is a brief overview of the cavity trays available:

EVERDRY STEPPED



Stepped cavity tray system with variable bed thickness options for brick, block and stone work. Available leaded and unleaded.

INTER-LOC HORIZONTAL



Pre-formed horizontal cavity tray system for new build and existing walls. Leaded and unleaded options available.

SYSTEM 2000 HORIZONTAL



Horizontal cavity tray system suitable for new build brick/block/stone work constructions.

SYSTEM 2000E HORIZONTAL



Horizontal cavity trays suitable for remedial work on existing brick, block or stone work.

LINTEL TRAYS



For installation directly above modern steel lintels in external cavity walls.

THRESHOLD TRAYS

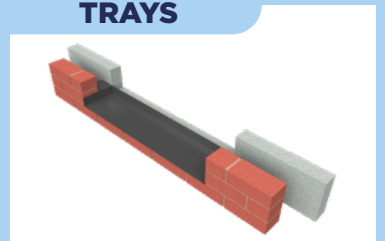

Preformed DPC threshold protection trays to suit standard openings.

GENERAL PURPOSE



For installation in various applications such as above floor beams, roof abutments and meter boxes.

HORIZONTAL PARAPET



For installation directly into the internal wall of parapet wall applications.

PURPOSE MADE



Special made-to-measure damp proof course units for DPC applications.

DOOR & WINDOW



Made-to-measure for all types of door and window arches and circular windows.

PLOT-SPECIFIC DELIVERY

Plot delivery is available for leaded, unleaded and polystrip cavity trays. There will be a 25% surcharge for unleaded and polystrip tray plot deliveries.

Please specify on your order if you require this service.

EVERDRY STEPPED CAVITY TRAYS **BRICKWORK**



USE

- At the abutment of a pitched roof with a cavity wall
- On external walls - not exceeding 120mm thickness - built from standard brickwork or similar sized components with regular course heights, including mortar of approx. 75mm
- On roof pitches of 10° and above



Intermediate tray (LH)



Stopend starter tray (LH/RH)

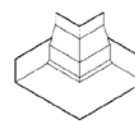

Corner starter tray (LH/RH)



Ridge tray

PRODUCTS IN THE RANGE

Intermediate trays: Forms main tray run with one tray on each course of brickwork running the full length of the abutting roof slope.

Stopend starters: Suits all roof pitches - first component to be installed and fitted at the lowest point on a standard abutment. Collects water gathered by the rest of the system and discharges it from the wall through a weep hole.

Corner starter trays: Suits all roof pitches - has same function as stopend starter tray but is used where the abutting roof comes up to, or beyond, the corner of the main building. Designed to return around the corner of the building to provide complete protection.

Ridge trays: Suits all roof pitches - used where a right hand and left hand roof slope come together at an apex to straddle the top two intermediate trays.

STEPPED CAVITY TRAYS SLOPING MEASUREMENT ROOF PITCH	COURSING HEIGHT 75MM BRICK
10°	2.3
12.5°	2.9
15°	3.5
17.5°	4.0
20°	4.6
22.5°	5.1
25°	5.6
27.5°	6.2
30°	6.7
32.5°	7.2
35°	7.7
37.5°	8.1
40°	8.6
42.5°	9.0
45°	9.4

STEPPED CAVITY TRAYS HORIZONTAL MEASUREMENT ROOF PITCH	COURSING HEIGHT 75MM BRICK
10°	2.4
12.5°	3.0
15°	3.6
17.5°	4.2
20°	4.9
22.5°	5.5
25°	6.2
27.5°	7.0
30°	7.7
32.5°	8.5
35°	9.3
37.5°	10.2
40°	11.2
42.5°	12.2
45°	13.3

DESCRIPTION	LENGTH	HANDING	75MM BRICK COURSING PRODUCT CODES TO SUIT CLEAR CAVITY WIDTHS OF 50-110MM	LEAD TIME
Intermediate tray	225mm	RH	10001	Next Working Day
Intermediate tray	225mm	LH	10002	Next Working Day
Intermediate tray	420mm*	RH	10011	Next Working Day
Intermediate tray	420mm*	LH	10012	Next Working Day
Stopend starter tray	225mm	RH/LH	10031	Next Working Day
Corner starter tray	225mm	RH/LH	10041	Next Working Day
Ridge tray	225mm	N/A	10061	Next Working Day
Ridge tray	420mm	N/A	10062	Next Working Day

N.B * For roof pitches 15°- 22.5°. Stopend starter, corner starter and ridge trays suit all roof pitches. 525mm long tray available "fixed cavity" for roof pitches 10°-15°

For trays featuring the polystyrene strip mortar barrier insert 'P' at the end of the required product code. This may incur an additional charge.

EVERDRY STEPPED CAVITY TRAYS **STONEMWORK**



USE

- At the abutment of a pitched roof with a cavity wall
- On external walls - not exceeding 150mm thickness - built from natural or reconstituted stone with regular course heights, including mortar of approx. 150mm
- On roof pitches of 7.5° and above
- Contact Timloc Technical for larger cavity widths



Intermediate tray (LH)



Stopend starter tray (LH/RH)



Corner starter tray (RH)



Ridge tray

PRODUCTS IN THE RANGE

Intermediate trays: Forms main tray run with one tray on each course of stonework running the full length of the abutting roof slope.

Stopend starters: Suits all roof pitches - first component to be installed and fitted at the lowest point on a standard abutment. Collects water gathered by the rest of the system and discharges it from the wall through a weep hole.

Corner starter trays: Suits all roof pitches - has same function as stopend starter tray but is used where the abutting roof comes up to, or beyond, the corner of the main building. Designed to return around the corner of the building to provide complete protection.

Ridge trays: Suits all roof pitches. Used where a right hand and left hand roof slope come together at an apex to straddle the top two intermediate trays.

150MM STONE COURSING 100MM EXTERNAL WALL THICKNESS (BED)	DESCRIPTION	LENGTH	PRODUCT CODES TO SUIT CLEAR CAVITY WIDTHS OF:					
			50-74MM	LEAD TIME	75-99MM	LEAD TIME	100-125MM	LEAD TIME
	Intermediate tray RH	450mm	7101	Next Working Day	7103	3-5 Working Days	7105	3-5 Working Days
	Intermediate tray LH	450mm	7102	Next Working Day	7104	3-5 Working Days	7106	3-5 Working Days
	Intermediate tray RH	625mm	7111	3-5 Working Days	7113	3-5 Working Days	7115	3-5 Working Days
	Intermediate tray LH	625mm	7112	3-5 Working Days	7114	3-5 Working Days	7116	3-5 Working Days
	Intermediate tray RH	1250mm	7121	3-5 Working Days	7123	3-5 Working Days	7125	3-5 Working Days
	Intermediate tray LH	1250mm	7122	3-5 Working Days	7124	3-5 Working Days	7126	3-5 Working Days
	Stopend starter RH/LH	450mm	7131	Next Working Day	7133	3-5 Working Days	7135	3-5 Working Days
	Corner starter tray RH	550mm	7141	Next Working Day	7143	3-5 Working Days	7145	3-5 Working Days
	Corner starter tray LH	550mm	7142	Next Working Day	7144	3-5 Working Days	7146	3-5 Working Days
	Ridge tray	450mm	7161	Next Working Day	7162	3-5 Working Days	7163	3-5 Working Days

150MM STONE COURSING 125MM EXTERNAL WALL THICKNESS (BED)	DESCRIPTION	LENGTH	PRODUCT CODES TO SUIT CLEAR CAVITY WIDTHS OF:					
			50-74MM	LEAD TIME	75-99MM	LEAD TIME	100-125MM	LEAD TIME
	Intermediate tray RH	450mm	7103	3-5 Working Days	7105	3-5 Working Days	7107	3-5 Working Days
	Intermediate tray LH	450mm	7104	3-5 Working Days	7106	3-5 Working Days	7108	3-5 Working Days
	Intermediate tray RH	625mm	7113	3-5 Working Days	7115	3-5 Working Days	7117	3-5 Working Days
	Intermediate tray LH	625mm	7114	3-5 Working Days	7116	3-5 Working Days	7118	3-5 Working Days
	Intermediate tray RH	1250mm	7123	3-5 Working Days	7125	3-5 Working Days	7127	3-5 Working Days
	Intermediate tray LH	1250mm	7124	3-5 Working Days	7126	3-5 Working Days	7128	3-5 Working Days
	Stopend starter RH/LH	450mm	7133	3-5 Working Days	7135	3-5 Working Days	7137	3-5 Working Days
	Corner starter tray RH	550mm	7143	3-5 Working Days	7145	3-5 Working Days	7147	3-5 Working Days
	Corner starter tray LH	550mm	7144	3-5 Working Days	7146	3-5 Working Days	7148	3-5 Working Days
	Ridge tray	450mm	7162	Next Working Day	7163	3-5 Working Days	7164	3-5 Working Days

150MM STONE COURSING 150MM EXTERNAL WALL THICKNESS (BED)	DESCRIPTION	LENGTH	PRODUCT CODES TO SUIT CLEAR CAVITY WIDTHS OF:					
			50-74MM	LEAD TIME	75-99MM	LEAD TIME	100-125MM	LEAD TIME
	Intermediate tray RH	450mm	7105	3-5 Working Days	7107	3-5 Working Days	7109	3-5 Working Days
	Intermediate tray LH	450mm	7106	3-5 Working Days	7108	3-5 Working Days	7110	3-5 Working Days
	Intermediate tray RH	625mm	7115	3-5 Working Days	7117	3-5 Working Days	7119	3-5 Working Days
	Intermediate tray LH	625mm	7116	3-5 Working Days	7118	3-5 Working Days	7120	3-5 Working Days
	Intermediate tray RH	1250mm	7125	3-5 Working Days	7127	3-5 Working Days	7129	3-5 Working Days
	Intermediate tray LH	1250mm	7126	3-5 Working Days	7128	3-5 Working Days	7130	3-5 Working Days
	Stopend starter RH/LH	450mm	7135	3-5 Working Days	7137	3-5 Working Days	7139	3-5 Working Days
	Corner starter tray RH	550mm	7145	3-5 Working Days	7147	3-5 Working Days	7149	3-5 Working Days
	Corner starter tray LH	550mm	7146	3-5 Working Days	7148	3-5 Working Days	7150	3-5 Working Days
	Ridge tray	450mm	7163	Next Working Day	7164	3-5 Working Days	7165	3-5 Working Days

For trays featuring the polystyrene strip mortar barrier insert 'P' at the end of the required product code. This may incur an additional charge.

EVERDRY STEPPED CAVITY TRAYS **BLOCKWORK**



USE

- At the abutment of a pitched roof with a cavity wall
- On external walls - not exceeding 150mm thickness - built from blockwork or stone with regular course heights, including mortar of approx. 225mm
- On roof pitches of 12.5° and above
- Contact Timloc Technical for larger cavity widths



Intermediate tray (LH)

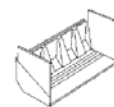

Stopend starter tray (LH/RH)

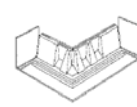

Corner starter tray (RH)



Ridge tray

PRODUCTS IN THE RANGE

Intermediate trays: Forms main tray run with one tray on each course of blockwork/stonework running the full length of the abutting roof slope.

Stopend starters: Suits all roof pitches - first component to be installed and fitted at the lowest point on a standard abutment. Collects water gathered by the rest of the system and discharges it from the wall through a weep hole.

Corner starter trays: Suits all roof pitches - has same function as stopend starter tray but is used where the abutting roof comes up to, or beyond, the corner of the main building. Designed to return around the corner of the building to provide complete protection.

Ridge trays: Suits all roof pitches - used where a right hand and left hand roof slope come together at an apex to straddle the top two intermediate trays.

225MM BLOCK COURSING 100MM EXTERNAL WALL THICKNESS (BED)

DESCRIPTION	LENGTH	PRODUCT CODES TO SUIT CLEAR CAVITY WIDTHS OF:					
		50-74MM	LEAD TIME	75-99MM	LEAD TIME	100-125MM	LEAD TIME
Intermediate tray RH	625mm	7201	Next Working Day	7203	3-5 Working Days	7205	3-5 Working Days
Intermediate tray LH	625mm	7202	Next Working Day	7204	3-5 Working Days	7206	3-5 Working Days
Intermediate tray RH	1250mm	7211	3-5 Working Days	7213	3-5 Working Days	7215	3-5 Working Days
Intermediate tray LH	1250mm	7212	3-5 Working Days	7214	3-5 Working Days	7216	3-5 Working Days
Stopend starter RH/LH	450mm	7231	Next Working Day	7233	3-5 Working Days	7235	3-5 Working Days
Corner starter tray RH	550mm	7241	3-5 Working Days	7243	3-5 Working Days	7245	3-5 Working Days
Corner starter tray LH	550mm	7242	3-5 Working Days	7244	3-5 Working Days	7246	3-5 Working Days
Ridge tray	625mm	7261	Next Working Day	7262	3-5 Working Days	7263	3-5 Working Days

225MM BLOCK COURSING 125MM EXTERNAL WALL THICKNESS (BED)

DESCRIPTION	LENGTH	PRODUCT CODES TO SUIT CLEAR CAVITY WIDTHS OF:					
		50-74MM	LEAD TIME	75-99MM	LEAD TIME	100-125MM	LEAD TIME
Intermediate tray RH	625mm	7203	3-5 Working Days	7205	3-5 Working Days	7207	3-5 Working Days
Intermediate tray LH	625mm	7204	3-5 Working Days	7206	3-5 Working Days	7208	3-5 Working Days
Intermediate tray RH	1250mm	7213	3-5 Working Days	7215	3-5 Working Days	7217	3-5 Working Days
Intermediate tray LH	1250mm	7214	3-5 Working Days	7216	3-5 Working Days	7218	3-5 Working Days
Stopend starter RH/LH	450mm	7233	3-5 Working Days	7235	3-5 Working Days	7237	3-5 Working Days
Corner starter tray RH	550mm	7243	3-5 Working Days	7245	3-5 Working Days	7247	3-5 Working Days
Corner starter tray LH	550mm	7244	3-5 Working Days	7246	3-5 Working Days	7248	3-5 Working Days
Ridge tray	625mm	7262	3-5 Working Days	7263	3-5 Working Days	7264	3-5 Working Days

225MM BLOCK COURSING 150MM EXTERNAL WALL THICKNESS (BED)

DESCRIPTION	LENGTH	PRODUCT CODES TO SUIT CLEAR CAVITY WIDTHS OF:					
		50-74MM	LEAD TIME	75-99MM	LEAD TIME	100-125MM	LEAD TIME
Intermediate tray RH	625mm	7205	3-5 Working Days	7207	3-5 Working Days	7209	3-5 Working Days
Intermediate tray LH	625mm	7206	3-5 Working Days	7208	3-5 Working Days	7210	3-5 Working Days
Intermediate tray RH	1250mm	7215	3-5 Working Days	7217	3-5 Working Days	7219	3-5 Working Days
Intermediate tray LH	1250mm	7216	3-5 Working Days	7218	3-5 Working Days	7220	3-5 Working Days
Stopend starter RH/LH	450mm	7235	3-5 Working Days	7237	3-5 Working Days	7239	3-5 Working Days
Corner starter tray RH	550mm	7245	3-5 Working Days	7247	3-5 Working Days	7249	3-5 Working Days
Corner starter tray LH	550mm	7246	3-5 Working Days	7248	3-5 Working Days	7250	3-5 Working Days
Ridge tray	625mm	7263	3-5 Working Days	7264	3-5 Working Days	7265	3-5 Working Days

For trays featuring the polystyrene strip mortar barrier insert 'P' at the end of the required product code. This may incur an additional charge.

EVERDRY STEPPED CAVITY TRAYS **BRICKWORK** LEADED



USE

- At the abutment of a pitched roof with a cavity wall
- On external walls - not exceeding 120mm thickness - built from standard brickwork or similar sized components with regular course heights, including mortar of approx. 75mm
- On roof pitches of 10° and above



Intermediate tray (LH) Short Lead

Intermediate tray (LH) Long Lead

Stopend starter tray (LH) Short Lead

Corner starter tray (LH) Long Lead

Ridge tray

PRODUCTS IN THE RANGE

Intermediate trays: Forms main tray run with one tray on each course of brickwork running the full length of the abutting roof slope.

Stopend starters: Suits all roof pitches - first component to be installed and fitted at the lowest point on a standard abutment. Collects water gathered by the rest of the system and discharges it from the wall through a weep hole.

Corner starter trays: Suits all roof pitches - has same function as stopend starter tray but is used where the abutting roof comes up to, or beyond, the corner of the main building. Designed to return around the corner of the building to provide complete protection.

Ridge trays: Suits all roof pitches - used where a right hand and left hand roof slope come together at an apex to straddle the top two intermediate trays.

STEPPED CAVITY TRAYS SLOPING MEASUREMENT ROOF PITCH	COURSING HEIGHT 75MM BRICK
10°	2.3
12.5°	2.9
15°	3.5
17.5°	4.0
20°	4.6
22.5°	5.1
25°	5.6
27.5°	6.2
30°	6.7
32.5°	7.2
35°	7.7
37.5°	8.1
40°	8.6
42.5°	9.0
45°	9.4

STEPPED CAVITY TRAYS HORIZONTAL MEASUREMENT ROOF PITCH	COURSING HEIGHT 75MM BRICK
10°	2.4
12.5°	3.0
15°	3.6
17.5°	4.2
20°	4.9
22.5°	5.5
25°	6.2
27.5°	7.0
30°	7.7
32.5°	8.5
35°	9.3
37.5°	10.2
40°	11.2
42.5°	12.2
45°	13.3

DESCRIPTION	LENGTH	HANDING	75MM BRICK COURSING PRODUCT CODES TO SUIT CLEAR CAVITY WIDTHS OF 50-110MM	LEAD TIME
Intermediate tray	Varies	RH	20001	3-5 Working Days for 10° - 22.5°. Next Working Day available on 25° and above only.
Intermediate tray	Varies	LH	20002	
Stopend starter tray	225mm	RH/LH	20031/32	
Corner starter tray	225mm	RH/LH	20041/42	
Ridge tray	225mm	N/A	20061	
Ridge tray	420mm	N/A	20062	

When ordering, please state roof pitch and whether long or short leads are required.

N.B Intermediate trays are 225mm in length at roof pitches of 27.5 degrees and above. Below this pitch the length increases to 420mm and 525mm.

EVERDRY STEPPED CAVITY TRAYS **STONEWORK** LEADED



USE

- At the abutment of a pitched roof with a cavity wall
- On external walls - not exceeding 150mm thickness - built from natural or reconstituted stone with regular course heights, including mortar of approx. 150mm
- On roof pitches of 15° and above



Intermediate tray (LH) Long Lead



Stopend starter tray (LH) Long Lead



Ridge tray

PRODUCTS IN THE RANGE

Intermediate trays: Forms main tray run with one tray on each course of stonework running the full length of the abutting roof slope.

Stopend starters: Suits all roof pitches - first component to be installed and fitted at the lowest point on a standard abutment. Collects water gathered by the rest of the system and discharges it from the wall through a weep hole.

Corner starter trays: Suits all roof pitches. Same function as stopend starter tray but is used where the abutting roof comes up to, or beyond, the corner of the main building. Designed to return around the corner of the building for complete protection. Corner starter trays are not supplied with factory fitted lead flashings due to the size and weight of lead flashing required. Flashing in this area should be dealt with separately in the traditional way.

Ridge trays: Suits all roof pitches. Used where a right hand and left hand roof slope come together at an apex to straddle the top two intermediate trays.

DESCRIPTION	LENGTH	PRODUCT CODES TO SUIT CLEAR CAVITY WIDTHS OF:					
		50-74MM	LEAD TIME	75-99MM	LEAD TIME	100-125MM	LEAD TIME
Intermediate tray RH	Varies	8101	3-5 Working Days	8103	3-5 Working Days	8105	3-5 Working Days
Intermediate tray LH	Varies	8102	3-5 Working Days	8104	3-5 Working Days	8106	3-5 Working Days
Stopend starter RH	450mm	8131	3-5 Working Days	8133	3-5 Working Days	8135	3-5 Working Days
Stopend starter LH	450mm	8132	3-5 Working Days	8134	3-5 Working Days	8136	3-5 Working Days
Corner starter tray RH*	550mm	7141	Next Working Day	7143	3-5 Working Days	7145	3-5 Working Days
Corner starter tray LH*	550mm	7142	Next Working Day	7144	3-5 Working Days	7146	3-5 Working Days
Ridge tray	450mm	8161	3-5 Working Days	8162	3-5 Working Days	8163	3-5 Working Days

DESCRIPTION	LENGTH	PRODUCT CODES TO SUIT CLEAR CAVITY WIDTHS OF:					
		50-74MM	LEAD TIME	75-99MM	LEAD TIME	100-125MM	LEAD TIME
Intermediate tray RH	Varies	8103	3-5 Working Days	8105	3-5 Working Days	8107	3-5 Working Days
Intermediate tray LH	Varies	8104	3-5 Working Days	8106	3-5 Working Days	8108	3-5 Working Days
Stopend starter RH	450mm	8133	3-5 Working Days	8135	3-5 Working Days	8137	3-5 Working Days
Stopend starter LH	450mm	8134	3-5 Working Days	8136	3-5 Working Days	8138	3-5 Working Days
Corner starter tray RH*	550mm	7143	3-5 Working Days	7145	3-5 Working Days	7147	3-5 Working Days
Corner starter tray LH*	550mm	7144	3-5 Working Days	7146	3-5 Working Days	7148	3-5 Working Days
Ridge tray	450mm	8162	3-5 Working Days	8163	3-5 Working Days	8164	3-5 Working Days

DESCRIPTION	LENGTH	PRODUCT CODES TO SUIT CLEAR CAVITY WIDTHS OF:					
		50-74MM	LEAD TIME	75-99MM	LEAD TIME	100-125MM	LEAD TIME
Intermediate tray RH	Varies	8105	3-5 Working Days	8107	3-5 Working Days	8109	3-5 Working Days
Intermediate tray LH	Varies	8106	3-5 Working Days	8108	3-5 Working Days	8110	3-5 Working Days
Stopend starter RH	450mm	8135	3-5 Working Days	8137	3-5 Working Days	8139	3-5 Working Days
Stopend starter LH	450mm	8136	3-5 Working Days	8138	3-5 Working Days	8140	3-5 Working Days
Corner starter tray RH*	550mm	7145	3-5 Working Days	7147	3-5 Working Days	7149	3-5 Working Days
Corner starter tray LH*	550mm	7146	3-5 Working Days	7148	3-5 Working Days	7150	3-5 Working Days
Ridge tray	450mm	8163	3-5 Working Days	8164	3-5 Working Days	8165	3-5 Working Days

When ordering, please state roof pitch and whether long or short leads are required.

N.B *Not supplied with factory fitted lead flashings.

EVERDRY STEPPED CAVITY TRAYS **BLOCKWORK** LEADED



USE

- At the abutment of a pitched roof with a cavity wall
- On external walls - not exceeding 150mm thickness - built from blockwork or stone with regular course heights, including mortar of approx. 225mm
- On roof pitches of 12.5° and above



Intermediate tray (LH) Long Lead



Stopend starter tray (LH) Long Lead



Ridge tray

PRODUCTS IN THE RANGE

Intermediate trays: Forms main tray run with one tray on each course of blockwork/stonework running the full length of the abutting roof slope.

Stopend starters: Suits all roof pitches - first component to be installed and fitted at the lowest point on a standard abutment. Collects water gathered by the rest of the system and discharges it from the wall through a weep hole.

Corner starter trays: Suits all roof pitches. Same function as stopend starter tray but is used where the abutting roof comes up to, or beyond, the corner of the main building. Designed to return around the corner of the building for complete protection. Corner starter trays are not supplied with factory fitted lead flashings due to the size and weight of lead flashing required. Flashing in this area should be dealt with separately in the traditional way.

Ridge trays: Suits all roof pitches. Used where a right hand and left hand roof slope come together at an apex to straddle the top two intermediate trays.

225MM BLOCK COURSING 100MM EXTERNAL WALL THICKNESS (BED)	DESCRIPTION	LENGTH	PRODUCT CODES TO SUIT CLEAR CAVITY WIDTHS OF:					
			50-74MM	LEAD TIME	75-99MM	LEAD TIME	100-125MM	LEAD TIME
	Intermediate tray RH	Varies	8201	3-5 Working Days	8203	3-5 Working Days	8205	3-5 Working Days
	Intermediate tray LH	Varies	8202	3-5 Working Days	8204	3-5 Working Days	8206	3-5 Working Days
	Stopend starter RH	450mm	8231	3-5 Working Days	8233	3-5 Working Days	8235	3-5 Working Days
	Stopend starter LH	450mm	8232	3-5 Working Days	8234	3-5 Working Days	8236	3-5 Working Days
	Corner starter tray RH*	550mm	7241	3-5 Working Days	7243	3-5 Working Days	7245	3-5 Working Days
	Corner starter tray LH*	550mm	7242	3-5 Working Days	7244	3-5 Working Days	7246	3-5 Working Days
	Ridge tray	450mm	8261	3-5 Working Days	8262	3-5 Working Days	8263	3-5 Working Days

225MM BLOCK COURSING 125MM EXTERNAL WALL THICKNESS (BED)	DESCRIPTION	LENGTH	PRODUCT CODES TO SUIT CLEAR CAVITY WIDTHS OF:					
			50-74MM	LEAD TIME	75-99MM	LEAD TIME	100-125MM	LEAD TIME
	Intermediate tray RH	Varies	8203	3-5 Working Days	8205	3-5 Working Days	8207	3-5 Working Days
	Intermediate tray LH	Varies	8204	3-5 Working Days	8206	3-5 Working Days	8208	3-5 Working Days
	Stopend starter RH	450mm	8233	3-5 Working Days	8235	3-5 Working Days	8237	3-5 Working Days
	Stopend starter LH	450mm	8234	3-5 Working Days	8236	3-5 Working Days	8238	3-5 Working Days
	Corner starter tray RH*	550mm	7243	3-5 Working Days	7245	3-5 Working Days	7247	3-5 Working Days
	Corner starter tray LH	550mm	7244	3-5 Working Days	7246	3-5 Working Days	7248	3-5 Working Days
	Ridge tray	450mm	8262	3-5 Working Days	8263	3-5 Working Days	8264	3-5 Working Days

225MM BLOCK COURSING 150MM EXTERNAL WALL THICKNESS (BED)	DESCRIPTION	LENGTH	PRODUCT CODES TO SUIT CLEAR CAVITY WIDTHS OF:					
			50-74MM	LEAD TIME	75-99MM	LEAD TIME	100-125MM	LEAD TIME
	Intermediate tray RH	Varies	8205	3-5 Working Days	8207	3-5 Working Days	8209	3-5 Working Days
	Intermediate tray LH	Varies	8206	3-5 Working Days	8208	3-5 Working Days	8210	3-5 Working Days
	Stopend starter RH	450mm	8235	3-5 Working Days	8237	3-5 Working Days	8239	3-5 Working Days
	Stopend starter LH	450mm	8236	3-5 Working Days	8238	3-5 Working Days	8240	3-5 Working Days
	Corner starter tray RH*	550mm	7245	3-5 Working Days	7247	3-5 Working Days	7249	3-5 Working Days
	Corner starter tray LH	550mm	7246	3-5 Working Days	7248	3-5 Working Days	7250	3-5 Working Days
	Ridge tray	450mm	8263	3-5 Working Days	8264	3-5 Working Days	8265	3-5 Working Days

When ordering, please state roof pitch and whether long or short leads are required.

N.B *Not supplied with factory fitted lead flashings.

INTER-LOC HORIZONTAL CAVITY TRAYS

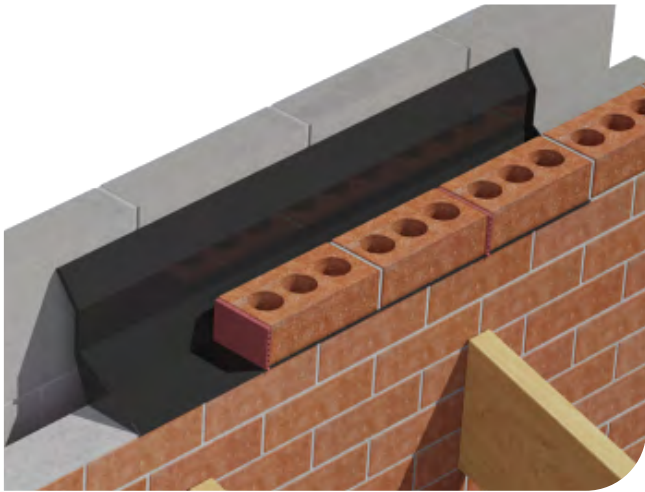

USE

- At the abutment of a flat roof with a cavity wall
- At the abutment of a lean-to or mono pitch roof with a cavity wall
- Over concrete ring beams
- Over airbricks, cavity liners, ducts, meter boxes, etc.
- On external walls - not exceeding 102.5mm in thickness - built from standard brick, block or stone
- Clear cavity widths of between 50-125mm



Existing build horizontal tray IL2/E



New build horizontal tray IL4



New build external corner EXT90

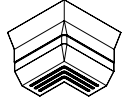

New build internal corner INT90

PRODUCTS IN THE RANGE

Horizontal Inter-loc cavity trays: The main cavity tray component sections join together by means of a lapped interlocking joint, to form the main cavity tray run. Water is gathered by the cavity tray and is discharged from the wall through a series of weep holes - one weep hole per Inter-loc tray is required.

Corner Units: Allows the integrity of the main cavity tray run to be maintained when it is necessary to turn a corner on a building. Available in either external or internal format.

Stopends: Fitted at the start and finish of the cavity tray run to seal off the open ends and prevent water running back into the cavity.

NEW BUILD APPLICATIONS	DESCRIPTION	EFFECTIVE LENGTH	PRODUCT CODE	LEAD TIME
	Inter-loc horizontal tray	4 brick / 900mm	IL4	Next Working Day
	Inter-loc horizontal tray	2 brick / 450mm	IL2	Next Working Day
	External 90° corner	1 brick / 220mm	EXT90	Next Working Day
	Internal 90° corner	1 brick / 220mm	INT90	Next Working Day
	External 135° corner	330mm	EXT135	3-5 Working Days
	Internal 135° corner	150mm	INT135	3-5 Working Days
	Stopend RH	-	SERH	Next Working Day
Stopend LH	-	SELH	Next Working Day	

EXISTING APPLICATIONS	DESCRIPTION	EFFECTIVE LENGTH	PRODUCT CODE	LEAD TIME
	Inter-loc horizontal tray	2 brick / 450mm	IL2/E	Next Working Day
	External 90° corner	1 brick / 220mm	EXT90/E	Next Working Day
	Internal 90° corner	1 brick / 220mm	INT90/E	Next Working Day
	External 135° corner	330mm	EXT135/E	3-5 Working Days
	Internal 135° corner	150mm	INT135/E	3-5 Working Days
	Stopend RH	-	SERH	Next Working Day
	Stopend LH	-	SELH	Next Working Day

For trays featuring the polystyrene strip mortar barrier insert 'P' at the end of the required product code. This may incur an additional charge.

INTER-LOC HORIZONTAL CAVITY TRAYS

LEADED

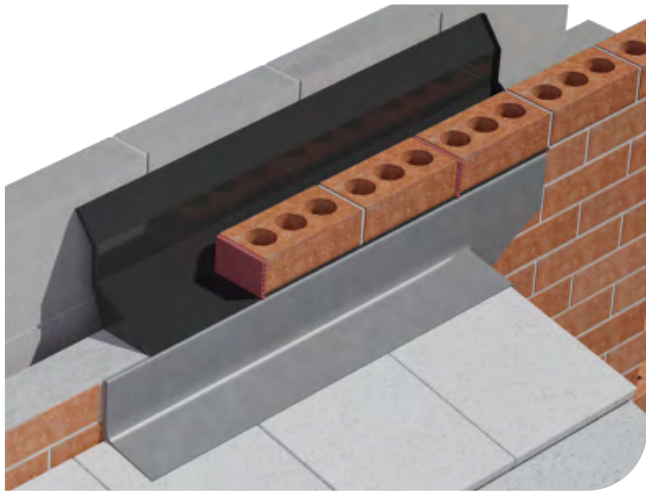

USE

- At the abutment of a flat roof with a cavity wall
- At the abutment of a lean-to or mono pitch roof with a cavity wall
- On external walls - not exceeding 102.5mm in thickness - built from standard brick, block or stone
- Clear cavity widths of between 50-125mm

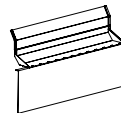

4 brick
300mm drop
lead IL4

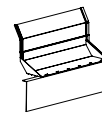

2 brick tray
150mm drop
lead IL2

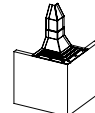

External corner
300mm drop
lead EXT90

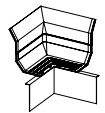

Internal corner
150mm drop
lead INT90

PRODUCTS IN THE RANGE

Horizontal Inter-loc cavity trays: The main cavity tray component sections join together by means of a lapped interlocking joint, to form the main cavity tray run. Water is gathered by the cavity tray and is discharged from the wall through a series of weep holes - one weep hole per Inter-loc tray is required.

Corner Units: Allows the integrity of the main cavity tray run to be maintained when it is necessary to turn a corner on a building. Available in either external or internal format.

Stopends: Fitted at the start and finish of the cavity tray run to seal off the open ends and prevent water running back into the cavity.

NEW BUILD APPLICATIONS 150MM DROP LEAD	DESCRIPTION	EFFECTIVE LENGTH	PRODUCT CODE	LEAD TIME
	Inter-loc horizontal tray	4 brick / 900mm	IL4L150	Next Working Day
Inter-loc horizontal tray	2 brick / 450mm	IL2L150	Next Working Day	
External 90° corner	1 brick / 220mm	EXT90L150	Next Working Day	
Internal 90° corner	1 brick / 220mm	INT90L150	Next Working Day	
External 135° corner	330mm	EXT135L150	3-5 Working Days	
Internal 135° corner	150mm	INT135L150	3-5 Working Days	
Stopend RH	-	SERH	Next Working Day	
Stopend LH	-	SELH	Next Working Day	

NEW BUILD APPLICATIONS 300MM DROP LEAD	DESCRIPTION	EFFECTIVE LENGTH	PRODUCT CODE	LEAD TIME
	Inter-loc horizontal tray	4 brick / 900mm	IL4L300	Next Working Day
Inter-loc horizontal tray	2 brick / 450mm	IL2L300	Next Working Day	
External 90° corner	1 brick / 220mm	EXT90L300	Next Working Day	
Internal 90° corner	1 brick / 220mm	INT90L300	Next Working Day	
External 135° corner	330mm	EXT135L300	3-5 Working Days	
Internal 135° corner	150mm	INT135L300	3-5 Working Days	
Stopend RH	-	SERH	Next Working Day	
Stopend LH	-	SELH	Next Working Day	

SYSTEM 2000 HORIZONTAL CAVITY TRAYS

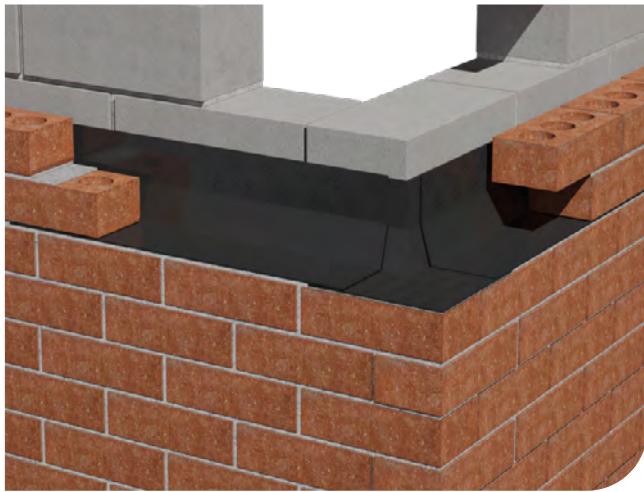

USE

- At the abutment of a flat roof with a cavity wall
- At the abutment of a lean-to or mono pitch roof with a cavity wall
- Over concrete ring beams
- Over airbricks, cavity liners, ducts, meter boxes, etc.
- Clear cavity widths of between 50-150mm



Horizontal tray

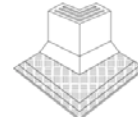

External corner



Internal corner

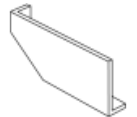

Stopend (LH)

PRODUCTS IN THE RANGE

Horizontal cavity trays: The main cavity tray component sections join together by means of a lapped joint, sealed with factory applied butyl masking tape, to form the main cavity tray run. Water is gathered by the cavity tray and is discharged from the wall through a series of weep holes.

Corner Units: Allows the integrity of the main cavity tray run to be maintained when it is necessary to turn a corner on a building. Available in either external or internal format.

Stopends: Fitted at the start and finish of the cavity tray run to seal off the open ends and prevent water running back into the cavity.

SYSTEM 2000 HORIZONTAL 50-99MM	DESCRIPTION	LENGTH	PRODUCT CODES TO SUIT CLEAR CAVITY WIDTHS OF:			
			50-74MM	LEAD TIME	75-99MM	LEAD TIME
			Horizontal tray	880/830mm	2075/880/50	Next Working Day
Horizontal tray	460/410mm	2075/460/50	Next Working Day	2075/460/75	Next Working Day	
External 90° corner	-	2010/50	Next Working Day	2010/75	Next Working Day	
Internal 90° corner	-	2011/50	Next Working Day	2011/75	Next Working Day	
External 135° corner	-	2012/50	3-5 Working Days	2012/75	3-5 Working Days	
Internal 135° corner	-	2013/50	3-5 Working Days	2013/75	3-5 Working Days	
Stopend RH	-	2003/50	Next Working Day	2003/75	Next Working Day	
Stopend LH	-	2004/50	Next Working Day	2004/75	Next Working Day	

SYSTEM 2000 HORIZONTAL 100-150MM	DESCRIPTION	LENGTH	PRODUCT CODES TO SUIT CLEAR CAVITY WIDTHS OF:			
			100-124MM	LEAD TIME	125-150MM	LEAD TIME
			Horizontal tray	880/830mm	2075/880/100	Next Working Day
Horizontal tray	460/410mm	2075/460/100	Next Working Day	2075/460/150	Next Working Day	
External 90° corner	-	2010/100	Next Working Day	2010/150	Next Working Day	
Internal 90° corner	-	2011/100	Next Working Day	2011/150	Next Working Day	
External 135° corner	-	2012/100	3-5 Working Days	2012/150	3-5 Working Days	
Internal 135° corner	-	2013/100	3-5 Working Days	2013/150	3-5 Working Days	
Stopend RH	-	2003/100	Next Working Day	2003/150	Next Working Day	
Stopend LH	-	2004/100	Next Working Day	2004/150	Next Working Day	

For trays featuring the polystyrene strip mortar barrier insert 'P' at the end of the required product code. This may incur an additional charge.

SYSTEM 2000E HORIZONTAL CAVITY TRAYS

REFURBISHMENT



USE

- For remedial work where a horizontal cavity tray must be inserted into an existing wall
- At the abutment of a flat roof with a cavity wall
- At the abutment of a lean-to or mono pitch roof with a cavity wall
- Over airbricks, cavity liners, ducts, meter boxes, etc.
- On external walls - not exceeding 102.5mm in thickness - built from standard brick, block or stone
- Clear cavity widths of between 50-125mm



E-Horizontal tray



External corner

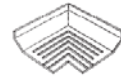

Internal corner



Stopend (LH)

PRODUCTS IN THE RANGE

Horizontal cavity trays: The main cavity tray component. Sections join together by means of a lapped joint, sealed with factory applied butyl mastic tape, to form the main cavity tray run. Water is gathered by the cavity tray and is discharged from the wall through a series of weep holes.

Corner Units: Allows the integrity of the main cavity tray run to be maintained when it is necessary to turn a corner on a building. Available in either external or internal format.

Stopends: Fitted at the start and finish of the cavity tray run to seal off the open ends and prevent water running back into the cavity.

SYSTEM 2000 HORIZONTAL 50-125MM	DESCRIPTION	LENGTH	PRODUCT CODES TO SUIT CLEAR CAVITY WIDTHS OF:					
			50-74MM	LEAD TIME	75-99MM	LEAD TIME	100-125MM	LEAD TIME
			Horizontal tray	460/440mm	2005/50	Next Working Day	2005/75	Next Working Day
External 90° corner	-	2006E/50	3-5 Working Days	2006E/75	3-5 Working Days	2006E/100	3-5 Working Days	
Internal 90° corner	-	2007E/50	3-5 Working Days	2007E/75	3-5 Working Days	2007E/100	3-5 Working Days	
Stopend RH	-	2003/50	Next Working Day	2003/75	Next Working Day	2003/100	Next Working Day	
Stopend LH	-	2004/50	Next Working Day	2004/75	Next Working Day	2004/100	Next Working Day	

SYSTEM 2000 HORIZONTAL CAVITY TRAYS

LEADED



USE

- At the abutment of a lean-to, flat or mono pitch roof and cavity wall
- On external walls - not exceeding 102.5mm in thickness - built from standard brickwork, blockwork or stone
- Clear cavity widths of between 50-125mm



Horizontal tray

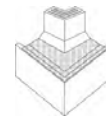

External corner



Internal corner



Stopend (LH)

PRODUCTS IN THE RANGE

Horizontal cavity trays: The main cavity tray component. Sections join together by means of a lapped joint, sealed with factory applied butyl mastic tape, to form the main cavity tray run. Water is gathered by the cavity tray and is discharged from the wall through a series of weep holes.

Corner Units: Allows the integrity of the main cavity tray run to be maintained when it is necessary to turn a corner on a building. Available in either external or internal format.

Stopends: Fitted at the start and finish of the cavity tray run to seal off the open ends and prevent water running back into the cavity.

DESCRIPTION	LENGTH	PRODUCT CODES TO SUIT CLEAR CAVITY WIDTHS OF:					
		50-74MM	LEAD TIME	75-99MM	LEAD TIME	100-125MM	LEAD TIME
Horizontal tray	880/830mm Short lead	2075/880/50/L150	3-5 Working Days	2075/880/75/L150	3-5 Working Days	2075/880/100/L150	3-5 Working Days
Horizontal tray	880/830mm Long lead	2075/880/50/L300	3-5 Working Days	2075/880/75/L300	3-5 Working Days	2075/880/100/L300	3-5 Working Days
Horizontal tray	460/410mm Short lead	2075/460/50/L150	3-5 Working Days	2075/460/75/L150	3-5 Working Days	2075/460/100/L150	3-5 Working Days
Horizontal tray	460/440mm Long lead	2075/460/50/L300	3-5 Working Days	2075/460/75/L300	3-5 Working Days	2075/460/100/L300	3-5 Working Days
External 90° corner	Short lead	2010L150/50	3-5 Working Days	2010L150/75	3-5 Working Days	2010L150/100	3-5 Working Days
External 90° corner	Long lead	2010L300/50	3-5 Working Days	2010L300/75	3-5 Working Days	2010L300/100	3-5 Working Days
Internal 90° corner	Short lead	2011L150/50	3-5 Working Days	2011L150/75	3-5 Working Days	2011L150/100	3-5 Working Days
Internal 90° corner	Long lead	2011L300/50	3-5 Working Days	2011L300/75	3-5 Working Days	2011L300/100	3-5 Working Days
External 135° corner	Long lead	2012L300/50	3-5 Working Days	2012L300/75	3-5 Working Days	2012L300/100	3-5 Working Days
Internal 135° corner	Long lead	2013L300/50	3-5 Working Days	2013L300/75	3-5 Working Days	2013L300/100	3-5 Working Days
Stopend RH	-	2003/50	Next Working Day	2003/75	Next Working Day	2003/100	Next Working Day
Stopend LH	-	2004/50	Next Working Day	2004/75	Next Working Day	2004/100	Next Working Day

GENERAL PURPOSE TRAYS



USE

- For installation in various applications
- Above floor beams
- Roof abutments
- Meter boxes

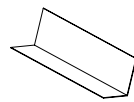

Horizontal tray

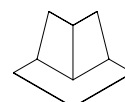

External corner

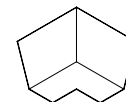

Internal corner

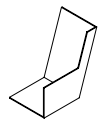

Stopend

PRODUCTS IN THE RANGE

Horizontal cavity trays: The main cavity tray component. Sections can be joined together by means of a sealing tape, such as Timloc's GTAPE01 (available separately) to form the main cavity tray run. Water is gathered by the cavity tray and is discharged from the wall through a series of weep holes.

Corner Units: Allows the integrity of the main cavity tray run to be maintained when it is necessary to turn a corner on a building. Available in either external or internal format.

Stopends: Fitted at the start and finish of the cavity tray run to seal off the open ends and prevent water running back into the cavity.

DESCRIPTION	LENGTH	PRODUCT CODES TO SUIT CLEAR CAVITY WIDTHS OF:					
		50-74MM	LEAD TIME	75-99MM	LEAD TIME	100-125MM	LEAD TIME
Horizontal tray	2500mm	5201	3-5 Working Days	5202	3-5 Working Days	5203	3-5 Working Days
External 90° corner	NA	5210	3-5 Working Days	5212	3-5 Working Days	5214	3-5 Working Days
Internal 90° corner	NA	5211	3-5 Working Days	5213	3-5 Working Days	5215	3-5 Working Days
Stopend RH	NA	5220	3-5 Working Days	5222	3-5 Working Days	5224	3-5 Working Days
Stopend LH	NA	5221	3-5 Working Days	5223	3-5 Working Days	5225	3-5 Working Days

HORIZONTAL PARAPET TRAYS

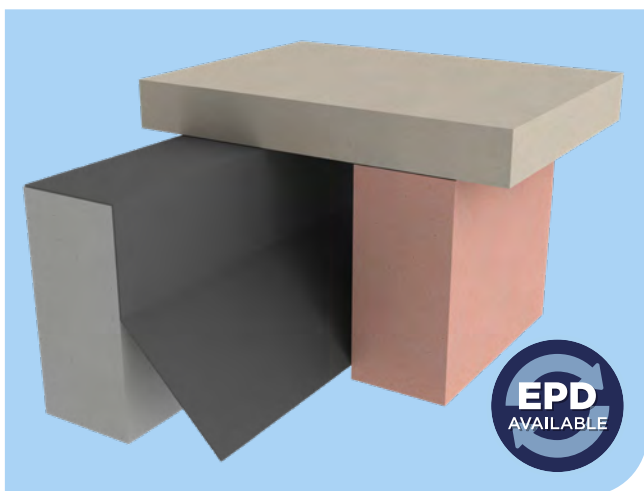

USE

- For installation directly into the internal wall of parapet wall applications

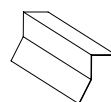

Horizontal tray

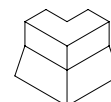

External corner

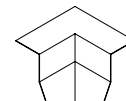

Internal corner

PRODUCTS IN THE RANGE

Horizontal parapet trays: The main cavity tray component. Sections can be joined together by means of a sealing tape, such as Timloc's GTAPE01 (available separately) to form the main cavity tray run. Water is gathered by the cavity tray and is discharged from the wall through a series of weep holes.

Corner Units: Allows the integrity of the main cavity tray run to be maintained when it is necessary to turn a corner on a building. Available in either external or internal format.

DESCRIPTION	LENGTH	PRODUCT CODES TO SUIT CLEAR CAVITY WIDTHS OF:					
		50-74MM	LEAD TIME	75-99MM	LEAD TIME	100-125MM	LEAD TIME
Horizontal parapet tray	2500mm	5301	3-5 Working Days	5302	3-5 Working Days	5303	3-5 Working Days
External 90° corner	NA	5310	3-5 Working Days	5312	3-5 Working Days	5314	3-5 Working Days
Internal 90° corner	NA	5311	3-5 Working Days	5313	3-5 Working Days	5315	3-5 Working Days

LINTEL TRAYS

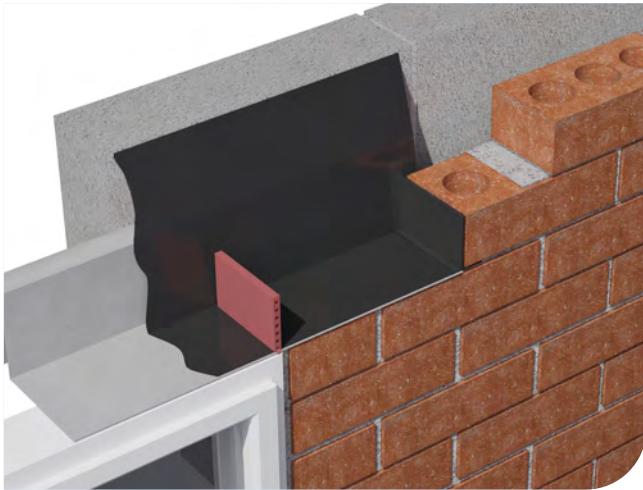

USE

- On steel lintels situated in external walls
- On external walls - not exceeding 102.5mm in thickness - built in standard brick, block or stone

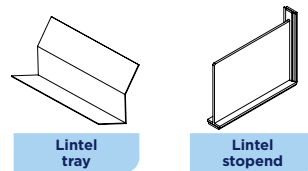

Lintel tray

Lintel stopend

PRODUCTS IN THE RANGE

Lintel trays: The main cavity tray component to be built over window and door openings. Allow 150mm overbearing either side, to be trimmed or joined when longer than 2500mm openings. Water is gathered by the cavity tray and is discharged from the wall through a series of weep holes.

Stopends: Fitted at the start and finish of the cavity tray run to seal off the open ends and prevent water running back into the cavity.

DESCRIPTION	RISE	LENGTH	PRODUCT CODES TO SUIT CLEAR CAVITY WIDTHS OF:					
			50-74MM	LEAD TIME	75-99MM	LEAD TIME	100-125MM	LEAD TIME
Lintel tray	100mm	2500mm	5001	3-5 Working Days	5002	3-5 Working Days	5003	3-5 Working Days
Lintel tray	150mm	2500mm	5004	3-5 Working Days	5005	3-5 Working Days	5006	3-5 Working Days
Lintel tray	225mm	2500mm	5007	3-5 Working Days	5008	3-5 Working Days	5009	3-5 Working Days

DESCRIPTION	PRODUCT CODE	LEAD TIME
Lintel stopend	LS01	Next Working Day

THRESHOLD TRAYS

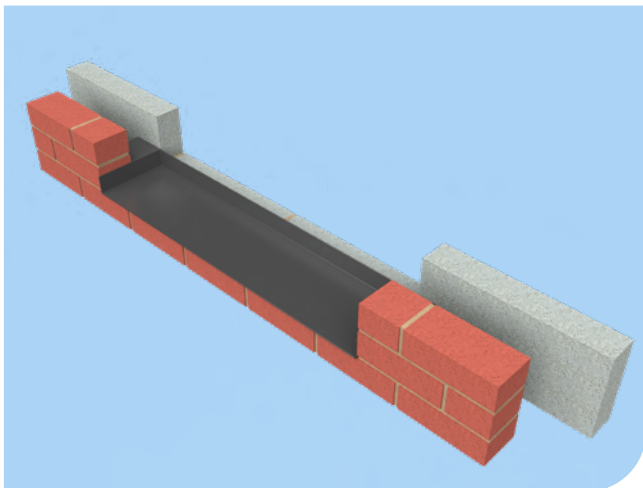

USE

- Preformed DPC threshold protection trays to suit standard openings



Threshold tray

PRODUCTS IN THE RANGE

Threshold protection trays: Pre-shaped, waterproof barrier fitted at low-level door openings to stop moisture from entering the building. It channels any water within the cavity safely outward and keeps the junction between inside and outside materials, like flooring, insulation and damp-proof layers protected. By providing reliable damp control at door thresholds, it supports compliance with building regulations for level access installations.

DESCRIPTION	LENGTH	PRODUCT CODE	LEAD TIME
DPC Threshold protection tray	Various	TPT01	3-5 Working Days

DOOR & WINDOW TRAYS

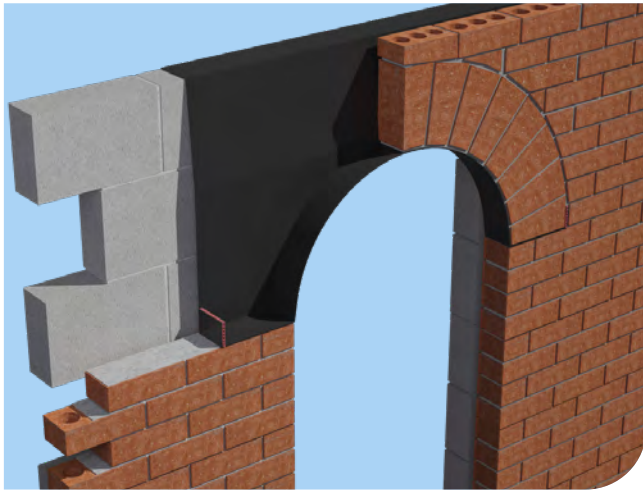

USE

- Around the opening of an external door or window with an arched top or a circular external window
- On external walls - built from brick, block or stone as well as timber frame constructions - of any thickness and any cavity width

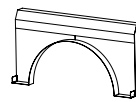

Arched door

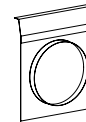

Circular window

HOW TO ORDER

Arch cavity trays are made to order, so please supply full construction details. Ideally these will include a fully dimensioned drawing showing door/window opening size and wall construction details. If this is not possible the minimum information required is:

- Thickness of outer leaf and cavity width
- Clear opening width and height of door/window opening
- Radius of curvature
- Position of spring line

With this data Timloc will be able to produce and despatch a dimensioned drawing for your approval.

PURPOSE MADE TRAYS

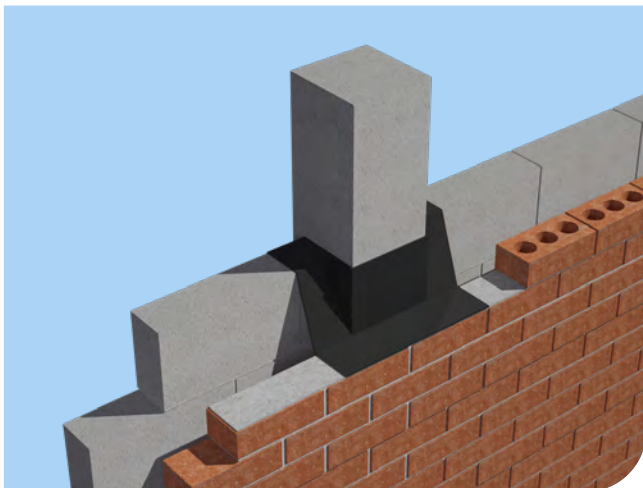

USE

- Made-to-measure trays for wherever DPC is used to form a horizontal cavity tray
- To substitute the cutting, moulding and sealing of a DPC when forming cavity trays, angles, stop ends etc.

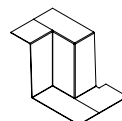

Door closer cloak (RH/LH)

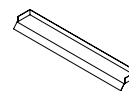

Threshold tray

PRODUCTS IN THE RANGE

- Cavity trays for brick support systems
- Parapet cavity tray systems
- Pier, column and corner cloaks
- Threshold trays
- Change of level units
- Radius units
- Stop end and junction cappings
- Ring beam cavity tray systems

HOW TO ORDER

These products are made to order, so please supply full construction details, ideally including fully dimensioned drawings.

TOP HATS, DPC & GAS BARRIERS

TOP HAT	39
FLEXIBLE TOP HATS	39
1201 TOP HAT	39
DAMP PROOF COURSING	40
RADON SUMP	41
ACCESSORIES	41



SCAN TO VIEW
THE RANGE ONLINE

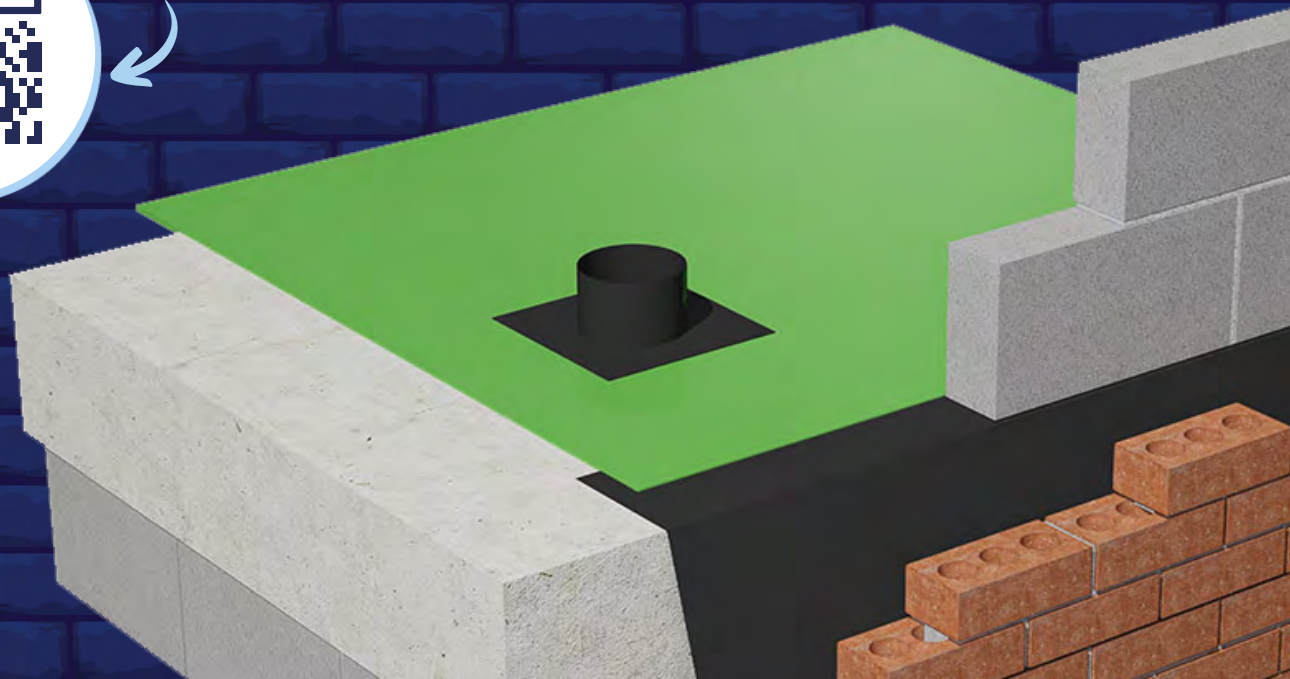

TOP HATS



USE

- In areas outlined in BRE document 'Radon' guidance on protective measures in new dwellings
- When gas protection is required across the building footprint
- Suitable for Radon, Hydrocarbon, Methane and CO₂

COLLAR SIZE	PACK QTY	PRODUCT CODE	LEAD TIME
55mm	1	TH055	3-5 Working Days
82mm	1	TH082	3-5 Working Days
110mm	1	TH110	Next Working Day
135mm	1	TH135	Next Working Day
160mm	1	TH160	Next Working Day

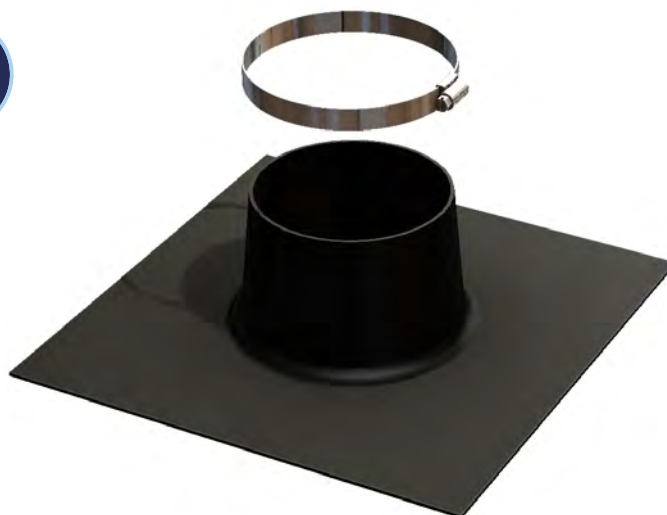

FLEXIBLE TOP HATS

USE

- In areas outlined in BRE document 'Radon' guidance on protective measures in new dwellings
- When gas protection is required across the building footprint
- Suitable for Radon, Hydrocarbon, Methane and CO₂

COLLAR SIZE	PACK QTY	PRODUCT CODE	LEAD TIME
110mm	1	77110	Next Working Day
135mm	1	77135	Next Working Day

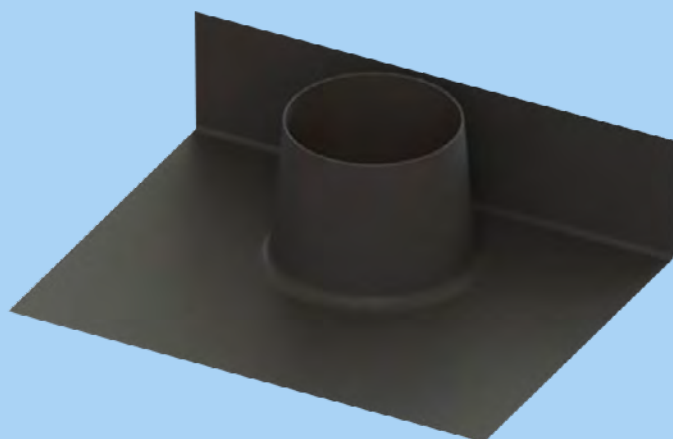

1201 TOP HATS

USE

- For sealing 1201 range of telescopic underfloor vents
- When gas protection is required
- Suitable for Radon, Hydrocarbon, Methane and CO₂

COLLAR SIZE	PACK QTY	PRODUCT CODE	LEAD TIME
214 x 46mm	1	77120	Next Working Day



DAMP PROOF COURSING

Preformed accessories to complete damp proof coursing (DPC) and horizontal cavity tray systems at vulnerable areas, such as corners and changes of level, to ensure protection from water ingress. **All DPC is available on a 3-5 working day turnaround.**

STOP ENDS

DESCRIPTION	HANDING	BUILT IN AT 150MM RISE			BUILT IN AT 225MM RISE		
		PRODUCT CODES TO SUIT CLEAR CAVITY WIDTHS OF:					
		50MM	75MM	100MM	50MM	75MM	100MM
Stop End - Full Height	RH	9010	9012	9014	9018	9020	9022
Stop End - Full Height	LH	9011	9013	9015	9019	9021	9023
Stop End - 75mm Height (Sloping)	RH	9045	9047	9049	9051	9053	9055
Stop End - 75mm Height (Sloping)	LH	9046	9048	9050	9052	9054	9056
Stop End - 75mm Height	Multi	9024	9024	9024	9024	9024	9024

CHANGE OF LEVEL

DESCRIPTION	HANDING	BUILT IN AT 150MM RISE			BUILT IN AT 225MM RISE		
		PRODUCT CODES TO SUIT CLEAR CAVITY WIDTHS OF:					
		50MM	75MM	100MM	50MM	75MM	100MM
Change of Level - 75mm Step	Multi	9060	9063	9066	9070	9073	9076
Change of Level - 150mm Step	Multi	9061	9064	9067	9071	9074	9067
Change of Level - 225mm Step	Multi	9062	9065	9068	9072	9075	9078

JOINT SUPPORT

DESCRIPTION	BUILT IN AT 150MM RISE			BUILT IN AT 225MM RISE		
	PRODUCT CODES TO SUIT CLEAR CAVITY WIDTHS OF:					
	50MM	75MM	100MM	50MM	75MM	100MM
Joint Support	9026	9027	9028	9030	9031	9032

DESCRIPTION	BUILT IN AT 150MM RISE			BUILT IN AT 225MM RISE		
	PRODUCT CODES TO SUIT CLEAR CAVITY WIDTHS OF:					
	50MM	75MM	100MM	50MM	75MM	100MM
Corner Unit	9001	9002	9003	9004	9005	9006

CORNER UNIT

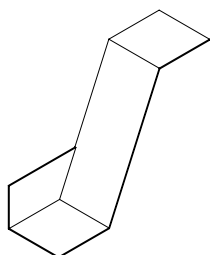

Stop ends

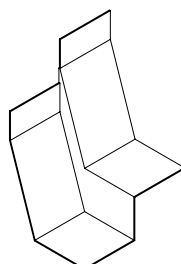

Change of level

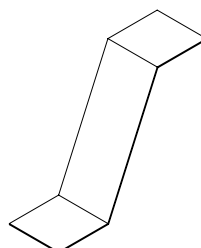

Joint support

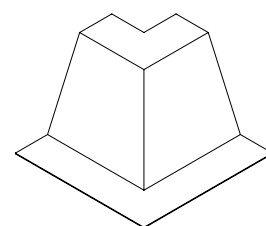

Corner unit

RADON SUMP

USE

- Where sub floor depressurisation is required under full radon protection
- Beneath the floor slab in non-suspended floor applications and vented via a 110mm drainage pipe to an external source and capped off with proprietary products i.e. airbrick, telescopic underfloor vent or roof vent

PACK QTY	PRODUCT CODE	LEAD TIME
1	RSUMP01	Next Working Day



**SIZE 5
FOR TH055**



**SIZE 6
FOR TH082 & TH110**



**SIZE 7
FOR TH135 & TH160**

ACCESSORIES

USE

- GTAPE01 is to be used to make the seal between joint surfaces
- GTAPE02 is used to seal upper surface to minimise lap lifting if used in concrete floors

DESCRIPTION	PACK QTY	PRODUCT CODE	LEAD TIME
Jubilee Clip 5	1	JCLIP5	Next Working Day
Jubilee Clip 6	1	JCLIP6	Next Working Day
Jubilee Clip 7	1	JCLIP7	Next Working Day
Gastite Sealing Tape	1	GTAPE01	Next Working Day
Girth Tape	1	GTAPE02	Next Working Day

CAVITY CLOSERS & STOP SOCKS

Fire-rated cavity closers & stop socks | Non-fire-rated cavity closers

THERMO-LOC MULTI CAVITY CLOSER	44
THERMO-LOC + CAVITY CLOSER	45
THERMO-LOC + FX CAVITY CLOSER	46
FR30 30-MINUTE FIRE RATED CAVITY CLOSER	47
FR60 60-MINUTE FIRE RATED CAVITY CLOSER	48
FR60+ 60-MINUTE FIRE RATED CAVITY CLOSER	48
FRSTOP CAVITY STOP SOCK MASONRY-MASONRY	50
TIMFRSTOP CAVITY STOP SOCK TIMBER-MASONRY	51
TTFRSTOP CAVITY STOP SOCK TIMBER-TIMBER	52
PWFRSTOP PARTY WALL CAVITY STOP SOCK MASONRY-MASONRY	53
PWTIMFRSTOP PARTY WALL CAVITY STOP SOCK TIMBER-MASONRY	54



SCAN TO VIEW
THE RANGE ONLINE



CAVITY CLOSERS & STOP SOCKS

Cavity closers and stop socks are fundamental elements of any cavity wall to help reduce condensation, cold bridging and mould growth. The range offers thermal, acoustic and fire protection depending on your requirements.

The Thermo-loc range is designed to lock warmth inside a building; offering greater protection against the risk of condensation, at a lower material thickness, when compared to standard cavity closers.

THERMO-LOC

Use the table below to help establish the cavity closer that suits your specification. Cavity stop sock table available on P.49

	THERMO-LOC MULTI	THERMO-LOC +	THERMO-LOC + FX	THERMO-LOC FR30	THERMO-LOC FR60	THERMO-LOC FR60+
PRODUCT CODE	CC2.4PPS/..	PP2.4/..	FX2.4/..	CC2.4FR/..	FR60/..	FR60/..
SHAPE	T	C	C FX	C FX	C FX	C FX
FIRE RATED	X	X	X	✓	✓	✓
CHECK REVEAL	X	✓	✓	✓	✓	X
PROFILE	50 - 100 SINGLE 100 - 150 SINGLE	50 - 100 SINGLE 105 - 150 DOUBLE	50 - 100 SINGLE 105 - 150 DOUBLE	50 - 100 SINGLE 105 - 300 DOUBLE	50 - 100 SINGLE 105 - 150 SINGLE	150 - 300 SINGLE
LENGTH	2.4M	2.4M	2.4M	2.4M	2.4M	2.4M
THICKNESS	20MM	25MM	25MM	25MM	30MM	50MM
MULTI OPTION	✓ UP TO 150MM	✓ UP TO 100MM	✓ UP TO 100MM	X	X	X
BUILDING REG. PARTS C&L COMPLIANT	✓	✓	✓	✓	✓	✓
BUILDING REG. PART B COMPLIANT	X	X	X	✓	✓	✓



TECHNICAL SUPPORT

Full product information is available on the Timloc website. If you require any further assistance please contact Technical via the details below:

Phone: **01405 782 769** | Email: **technical@timloc.co.uk**

Scan the QR code to view full product datasheets.

BUILD WITH CONFIDENCE USING BBA-APPROVED CLOSERS

Ensuring the quality and reliability of building materials is critical for safety, efficiency, and long-term durability in construction projects. A product where such assurance is vital is cavity closers.

That's why **BBA certification matters.**



Scan the QR code to read more.

Fire-rated and non fire-rated cavity closers designed to eliminate damp and cold bridging around doors, windows, and sills. Cavity closers available to suit a variety of applications on pages 44-48.

THERMO-LOC

MULTI CAVITY CLOSER

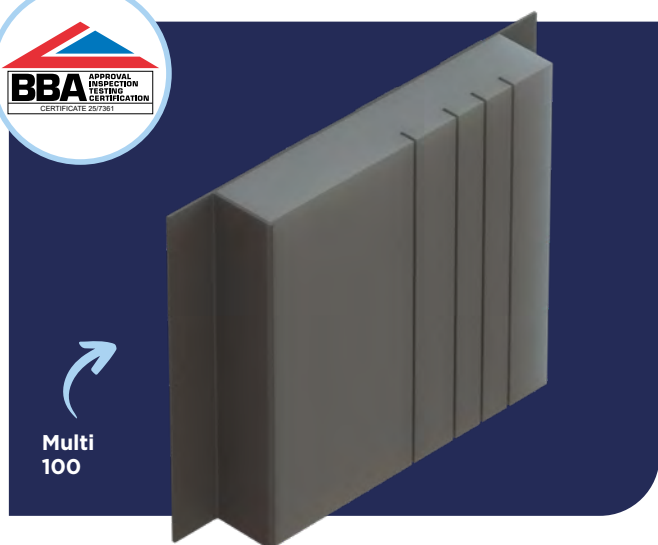

Multi 100

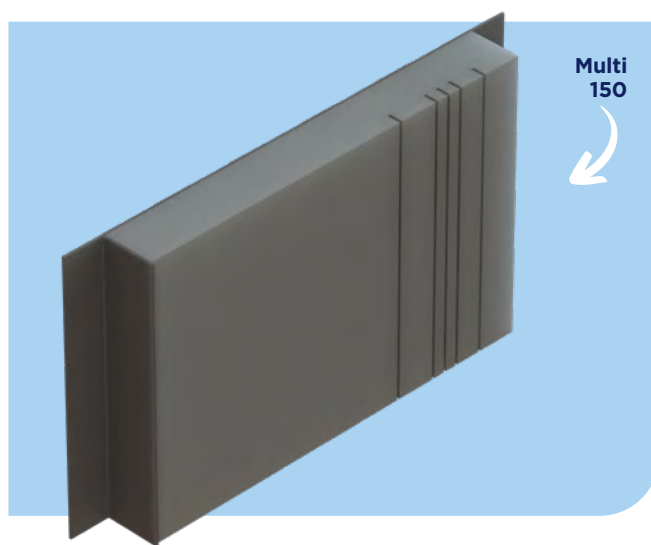

Multi 150

USE

- To close cavity at external doors, window jambs and sills
- To provide thermal insulation and prevent 'cold bridging'
- To provide DPC at external doors, window jambs or sills
- Suitable for cavities up to 150mm

Single Profile
50 - 100mm



Single Profile
100 - 150mm



Suitable for a range of cavity sizes up to 150mm by easily cutting to size using the pre-cut grooves. 20mm insulation thickness. Compliant with Building Regulation Approved Documents C, L1 and L2 and satisfies BRE document 'Thermal Insulation: avoiding risks'.

PRODUCT CODE	DESCRIPTION	CAVITY WIDTH	LENGTH	PACK QTY
CC2.4PPS/MULTI100	Thermo-loc Multi 50-100mm	50-100mm	2.4m	10
CC2.4PPS/MULTI150	Thermo-loc Multi 100-150mm	100-150mm	2.4m	10

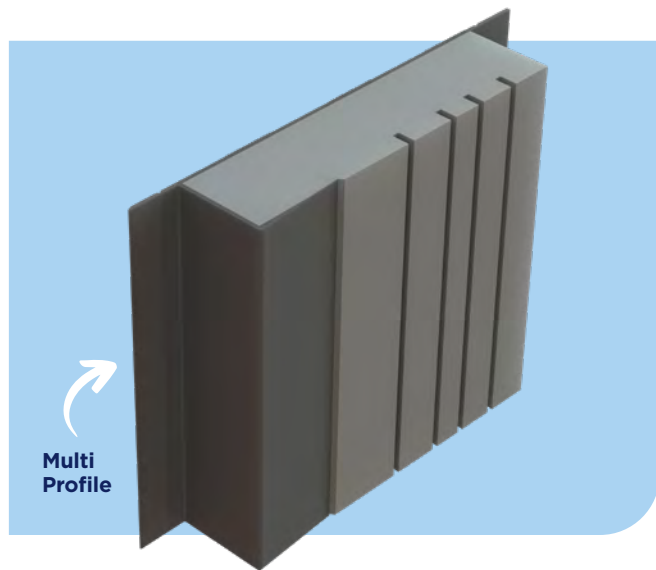
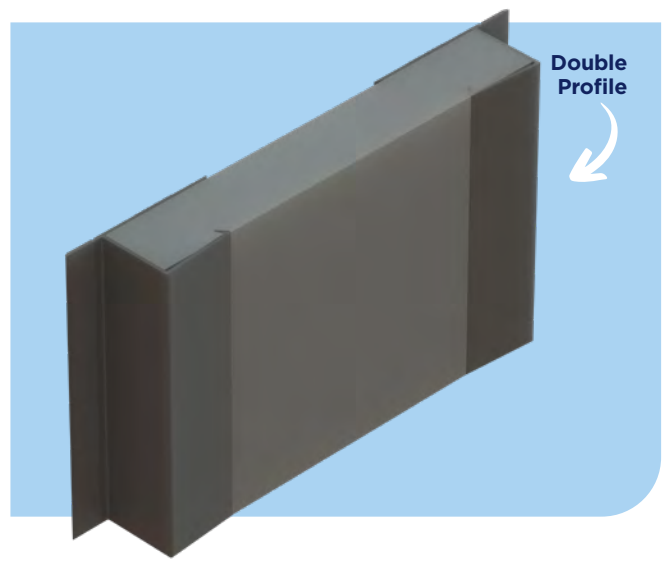
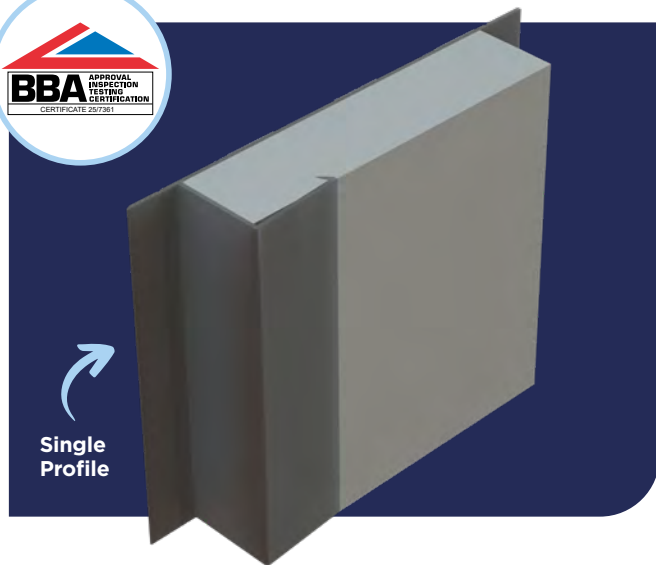

USE

- To close cavity at external doors, window jambs and sills
- To provide thermal insulation and prevent 'cold bridging'
- To provide DPC at external doors, window jambs or sills
- Suitable for cavities up to 150mm

Single Profile
50 - 100mm



Double Profile
105 - 150mm



Multi Check Reveal
Single Flange



Single profile for 50mm-100mm cavities, double profile for 105mm-150mm cavities, Multi and Check Reveal Multi options also available. 25mm insulation thickness. Compliant with Building Regulation Approved Documents C, L1 and L2 and satisfies BRE document 'Thermal Insulation: avoiding risks'.

PRODUCT CODE	DESCRIPTION	CAVITY WIDTH	LENGTH	PACK QTY
PP2.4/50	Thermo-loc +	50mm	2.4m	10
PP2.4/75	Thermo-loc +	75mm	2.4m	10
PP2.4/90	Thermo-loc +	90mm	2.4m	10
PP2.4/100	Thermo-loc +	100mm	2.4m	10
PP2.4/100MULTI	Thermo-loc + Multi	50-100mm	2.4m	10
PP2.4/120	Thermo-loc +	120mm	2.4m	10
PP2.4/125	Thermo-loc +	125mm	2.4m	10
PP2.4/130	Thermo-loc +	130mm	2.4m	10
PP2.4/150	Thermo-loc +	150mm	2.4m	10
PP2.4/CR100MULTI	Thermo-loc + CR Multi	50-100mm	2.4m	10

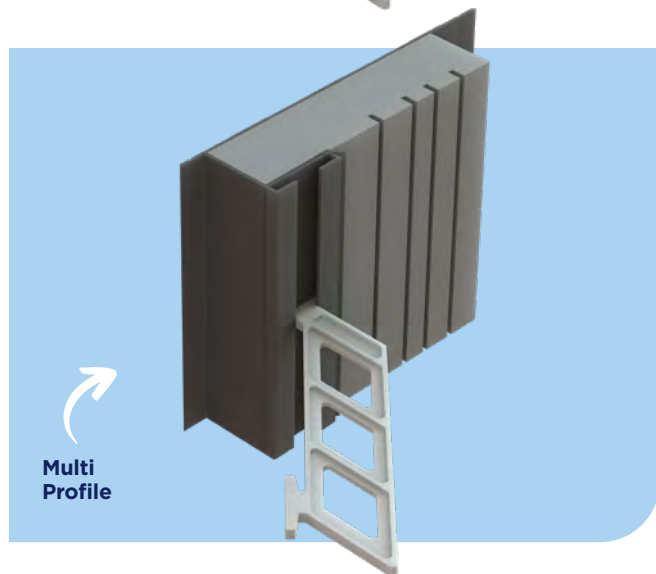
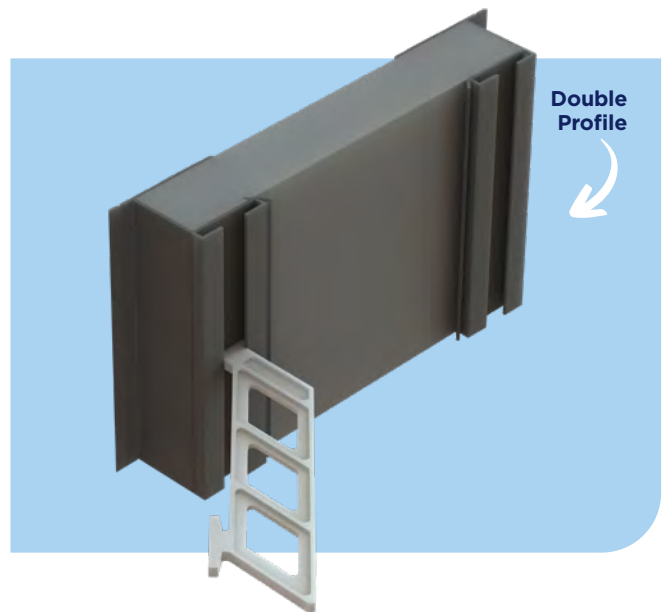
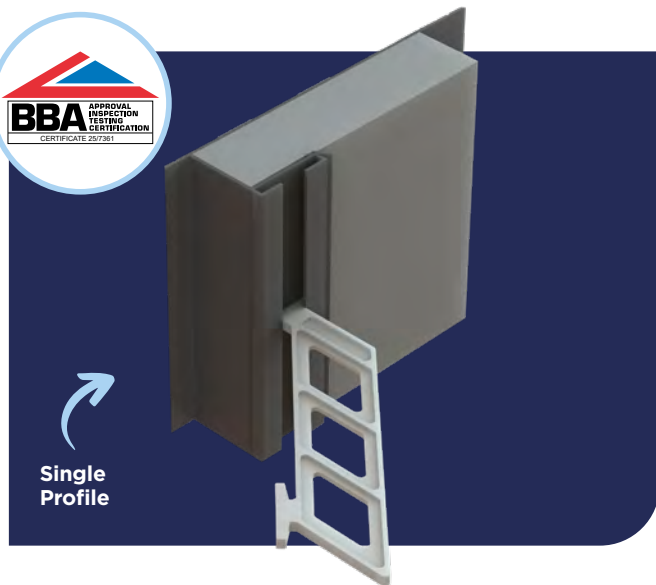

USE

- To close cavity at external doors, window jambs and sills
- To provide thermal insulation and prevent 'cold bridging'
- To provide DPC at external doors, window jambs or sills
- Suitable for cavities up to 150mm

Single Profile
50 - 100mm

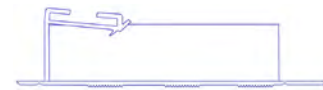

Double Profile
105 - 150mm



Multi Check Reveal
Single Flange



Single profile for 50mm-100mm cavities, double profile for 105mm-150mm cavities, Multi and Check Reveal options also available. 25mm insulation thickness. Compliant with Building Regulation Approved Documents C, L1 and L2 and satisfies BRE document 'Thermal Insulation: avoiding risks'.

PRODUCT CODE	DESCRIPTION	CAVITY WIDTH	LENGTH	PACK QTY
FX2.4/50	Thermo-loc + FX	50mm	2.4m	10
FX2.4/75	Thermo-loc + FX	75mm	2.4m	10
FX2.4/90	Thermo-loc + FX	90mm	2.4m	10
FX2.4/100	Thermo-loc + FX	100mm	2.4m	10
FX2.4/120	Thermo-loc + FX	120mm	2.4m	10
FX2.4/125	Thermo-loc + FX	125mm	2.4m	10
FX2.4/130	Thermo-loc + FX	130mm	2.4m	10
FX2.4/150	Thermo-loc + FX	150mm	2.4m	10
FX2.4/100MULTI	Thermo-loc + Multi FX	50-100mm	2.4m	10
FX2.4/CR50	Thermo-loc + FX CR	50mm	2.4m	10
FX2.4/CR100	Thermo-loc + FX CR	100mm	2.4m	10
FX2.4/CR125	Thermo-loc + FX CR	125mm	2.4m	10
FX2.4/CR150	Thermo-loc + FX CR	150mm	2.4m	10
FX2.4/CR100MULTI	Thermo-loc + CR Multi	50-100mm	2.4m	10
CCFIX	Fixing Ties	NA	NA	100

THERMO-LOC FIRE-RATED CAVITY CLOSERS

BUILD WITH CONFIDENCE USING BBA-APPROVED CLOSERS

Ensuring the quality and reliability of building materials is critical for safety, efficiency, and long-term durability in construction projects. A product where such assurance is vital is cavity closers.

That's why **BBA certification matters.**



Scan the QR code to read more.

Timloc Building Products offers a range of fire-rated cavity closers, each independently tested and certified by Warringtonfire in accordance with EN1366-4 principles.

Full product datasheets and test certificates are available from the Timloc website at: timloc.co.uk.

Scan the QR code to view the test certificates.



FR30

30-MINUTE FIRE-RATED CAVITY CLOSER

USE

- To close the cavity at external doors, window jambs and sills
- To provide thermal insulation and prevent 'cold bridging'
- To provide a DPC at external doors, window jambs or sills
- 30 minutes fire rating and minimum 15 minutes insulation
- Suitable for cavities up to 300mm
- Suitable for masonry walls only

FEATURES

- Single profile for 50-100mm cavities
- Double profile for 105-300mm cavities
- Supplied in 2.4m lengths
- 25mm insulation thickness
- Fully rebated and check reveal options available
- Building Reg. Approved Documents C, B, L1 and L2 compliant
- Satisfies BRE document 'Thermal Insulation: avoiding risks'

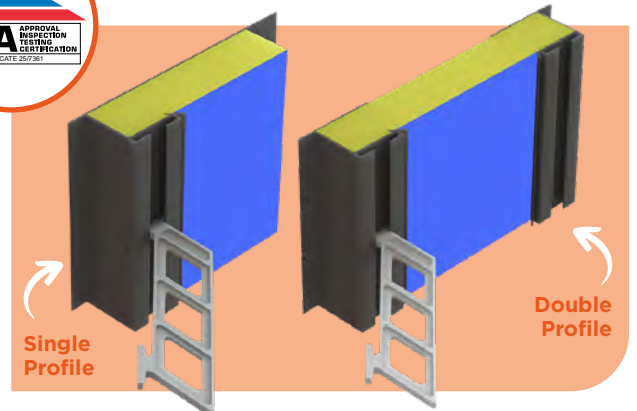

PRODUCT CODE	CAVITY WIDTH	PACK QTY
CC2.4FR/50	50mm	10
CC2.4FR/65	65mm	10
CC2.4FR/75	75mm	10
CC2.4FR/90	90mm	10
CC2.4FR/100	100mm	5
CC2.4FR/125	125mm	5
CC2.4FR/150	150mm	3

NB. Non standard cavity sizes up to 300mm are available to special order.



FR60

60-MINUTE FIRE-RATED CAVITY CLOSER



PRODUCT CODE	CR	CAVITY WIDTH	PACK QTY
FR60/50	No	50mm	5
FR60/100	No	100mm	5
FR60/125	No	125mm	5
FR60/150	No	150mm	5
FR60/CR50	Yes	50mm	5
FR60/CR100	Yes	100mm	5
FR60/CR125	Yes	125mm	5
FR60/CR150	Yes	150mm	5

USE

- To close the cavity at external doors, window jambs and sills
- To provide thermal insulation and prevent 'cold bridging'
- To provide a DPC at external doors, window jambs or sills
- 60 minutes fire rating and minimum 15 minutes insulation
- Suitable for cavities up to 150mm
- Suitable for masonry walls only

FEATURES

- Single profile for 50-100mm cavities and 105-150mm cavities
- Supplied in 2.4m lengths
- 30mm insulation thickness
- Fully rebated and check reveal options available
- Building Reg. Approved Documents C, B, L1 and L2 compliant
- Satisfies BRE document 'Thermal Insulation: avoiding risks'

FR60+

60-MINUTE FIRE-RATED CAVITY CLOSER

USE

- To close the cavity at external doors, window jambs and sills
- To provide thermal insulation and prevent 'cold bridging'
- To provide a DPC at external doors, window jambs or sills
- 60 minutes fire rating and minimum 15 minutes insulation
- Suitable for cavities over 150mm up to 300mm
- Suitable for masonry walls only

FEATURES

- Single profile for 151-300mm cavities
- 50mm insulation thickness
- Supplied with 4 metal fixing flanges to be slotted in place
- Supplied in 2.4m lengths
- Fully rebated option only
- Building Reg. Approved Documents C, B, L1 and L2 compliant
- Satisfies BRE document 'Thermal Insulation: avoiding risks'

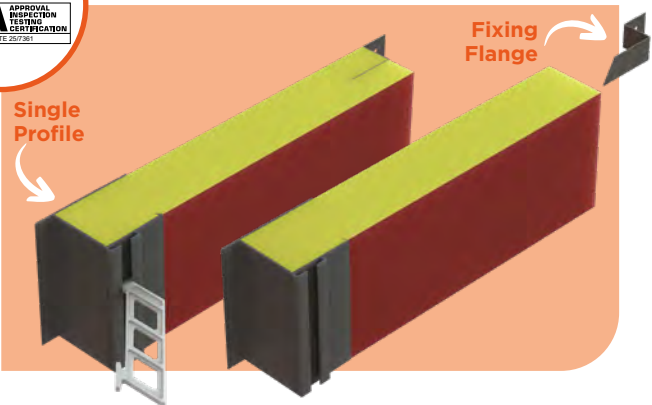

PRODUCT CODE	CAVITY WIDTH	PACK QTY
FR60/175	175mm	2
FR60/200	200mm	2
FR60/225	225mm	2
FR60/250	250mm	2
FR60/275	275mm	2
FR60/300	300mm	2

NEED SOMETHING EXTRA?

PRODUCT CODE	DESCRIPTION	PACK QTY
3322*	Fixing flanges	4
CCFIX	Fixing ties	100

*1 pack of fixing flanges supplied per length of Thermo-loc FR60 + cavity closer profile.

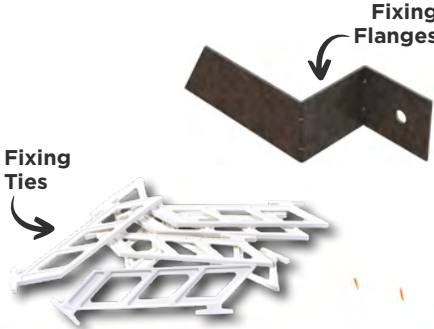

FRSTOP

CAVITY STOP SOCKS

60-minute fire-rated cavity stop socks available from Timloc Building Products suitable for a wide range of constructions and applications, including timber frame, masonry and party walls. Independently 3rd party tested and certified for 60-minute fire-rating. Available to suit various cavity widths up to either 150mm or 300mm where applicable.



60-MINUTE
FIRE-RATED



3RD PARTY
TESTED



WEATHER
PROTECTION

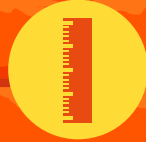

1200MM
LENGTHS



APPROVED
DOCUMENT B



ROBUST
DETAIL E



BS EN 13162
COMPLIANT



MINIMISES
NOISE

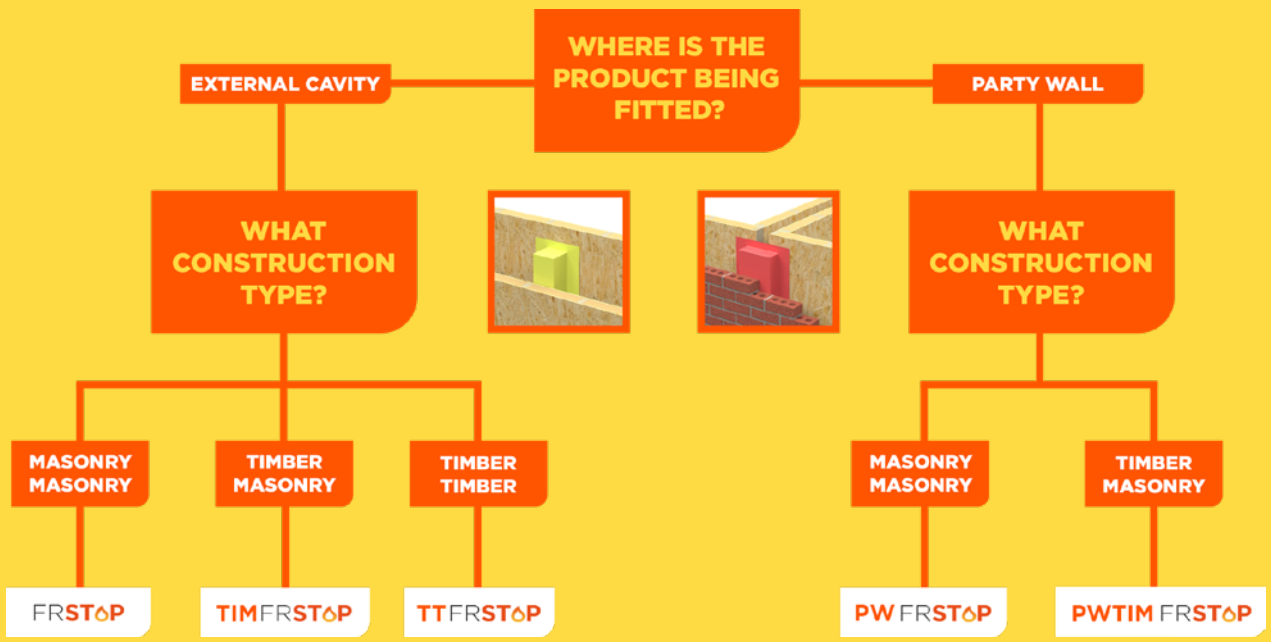

DESIGNED TO PROTECT

All fire-rated closers and stop socks are 3rd party tested by Warringtonfire in accordance with EN1366-4 principles.

Scan the QR code
to view test certificates.



FRSTOP

60-MINUTE FIRE-RATED CAVITY STOP SOCK FOR MASONRY-MASONRY



3rd party tested
by Warringtonfire
in accordance with
EN1366-4
principles

USE

- To restrict the spread of flames within external masonry-masonry cavity walls
- To further minimise the effect of flanking noise pollution at wall junctions
- To provide a cavity barrier at separating walls, separating floors and around window and door apertures



- FRSTOP cavity stop socks comprise a length of non-combustible mineral wool insulation sleeved in a polythene outer layer for on-site weather protection
- 60 minute fire integrity and minimum 15 minutes insulation
- Available to suit cavity widths from 50mm up to 300mm
- Supplied in 1.2m lengths

PRODUCT CODE	TO SUIT CAVITY WIDTH	DIMENSIONS	MIN. COMPRESSION	BAG COLOUR	PACK QUANTITY
FRSTOP50	50mm	65 x 65 x 1200mm	15mm	Yellow	20
FRSTOP75	66-75mm	85 x 85 x 1200mm	10mm	Blue	18
FRSTOP85	76-85mm	100 x 85 x 1200mm	15mm	Blue	12
FRSTOP90	86-90mm	100 x 85 x 1200mm	10mm	Blue	12
FRSTOP100	91-100mm	110 x 100 x 1200mm	10mm	Blue	1
FRSTOP115	101-115mm	130 x 100 x 1200mm	15mm	Green	1
FRSTOP125	116-125mm	140 x 100 x 1200mm	15mm	Green	1
FRSTOP150	141-150mm	160 x 120 x 1200mm	10mm	Red	1

NB. Non standard cavity sizes up to 300mm are available to special order. Bag colour may vary.

TIMFRSTOP

60-MINUTE FIRE-RATED CAVITY STOP SOCK FOR TIMBER-MASONRY

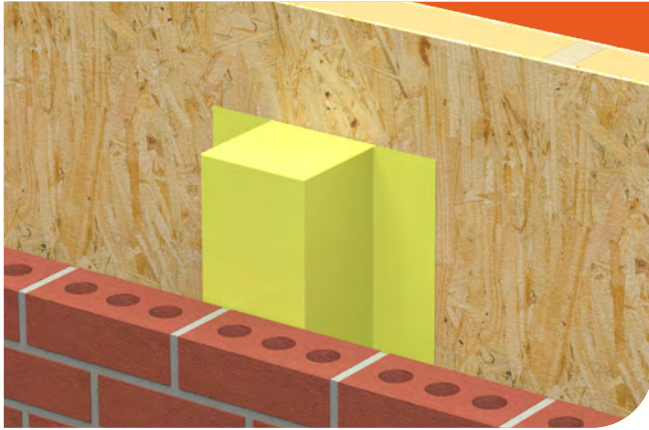

3rd party tested
by Warringtonfire
in accordance with
EN1366-4
principles



USE

- To restrict the spread of smoke and flames within external timber-masonry cavity walls
- To provide a cavity barrier at separating walls, separating floors and around window or door apertures
- To minimise heat loss and effect of flanking noise pollution through the cavity wall

- TIMFRSTOP cavity stop socks comprise a length of non-combustible mineral wool insulation sleeved in a polythene outer layer for on-site weather protection
- 60 minute fire integrity and insulation performance
- Available to suit cavity widths from 50mm up to 150mm
- Supplied in 1.2m lengths

PRODUCT CODE	TO SUIT CAVITY WIDTH	DIMENSIONS	MIN. COMPRESSION	BAG COLOUR	PACK QUANTITY	PALLET QUANTITY
TIMFRSTOP50	50mm	65 x 65 x 1200mm	15mm	Red	20	240
TIMFRSTOP65	51-65mm	85 x 75 x 1200mm	20mm	Red	18	216
TIMFRSTOP75	66-75mm	100 x 75 x 1200mm	25mm	Red	12	144
TIMFRSTOP85	76-85mm	100 x 150 x 1200mm	15mm	Yellow	NA	102
TIMFRSTOP90	86-90mm	110 x 150 x 1200mm	20mm	Yellow	NA	90
TIMFRSTOP100	91-100mm	120 x 150 x 1200mm	20mm	Yellow	NA	90
TIMFRSTOP115	101-115mm	130 x 150 x 1200mm	15mm	Yellow	NA	72
TIMFRSTOP125	116-125mm	140 x 150 x 1200mm	15mm	Yellow	NA	72
TIMFRSTOP130	126-130mm	150 x 150 x 1200mm	20mm	Yellow	NA	66
TIMFRSTOP140	131-140mm	160 x 150 x 1200mm	20mm	Yellow	NA	60
TIMFRSTOP150	141-150mm	160 x 150 x 1200mm	10mm	Yellow	NA	60

NB. Pallet quantities may vary slightly from the values stated above. Contact sales@timloc.co.uk for confirmation. Bag colour may vary.

TFRSTOP

60-MINUTE FIRE-RATED CAVITY STOP SOCK FOR TIMBER-TIMBER



3rd party tested
by Warringtonfire
in accordance with
EN1366-4
principles

USE



- To restrict the spread of smoke and flames within external timber-timber cavity walls
- To provide a cavity barrier at separating walls, separating floors and around window or door apertures
- To minimise heat loss and effect of flanking noise pollution through the cavity wall

- TFRSTOP cavity stop socks comprise a length of non-combustible mineral wool insulation sleeved in a polythene outer layer for on-site weather protection
- 60 minute fire integrity and insulation performance
- Available to suit cavity widths from 50mm up to 150mm
- Supplied in 1.2m lengths

PRODUCT CODE	TO SUIT CAVITY WIDTH	DIMENSIONS	MIN. COMPRESSION	BAG COLOUR	PALLET QUANTITY
TFRSTOP50	50mm	85 x 150 x 1200mm	35mm	Yellow	90
TFRSTOP65	51-65mm	100 x 150 x 1200mm	35mm	Yellow	102
TFRSTOP75	66-75mm	110 x 150 x 1200mm	35mm	Yellow	90
TFRSTOP85	76-85mm	120 x 150 x 1200mm	35mm	Yellow	84
TFRSTOP90	86-90mm	120 x 150 x 1200mm	30mm	Yellow	84
TFRSTOP100	91-100mm	130 x 150 x 1200mm	30mm	Yellow	78
TFRSTOP115	101-115mm	150 x 150 x 1200mm	35mm	Yellow	66
TFRSTOP125	116-125mm	160 x 150 x 1200mm	35mm	Yellow	60
TFRSTOP130	126-130mm	160 x 150 x 1200mm	30mm	Yellow	60
TFRSTOP140	131-140mm	175 x 150 x 1200mm	35mm	Yellow	54
TFRSTOP150	141-150mm	185 x 150 x 1200mm	35mm	Yellow	54

NB. Pallet quantities may vary slightly from the values stated above. Contact sales@timloc.co.uk for confirmation. Bag colour may vary.

PWFRSTOP

60-MINUTE FIRE-RATED PARTY WALL CAVITY STOP SOCK FOR MASONRY-MASONRY

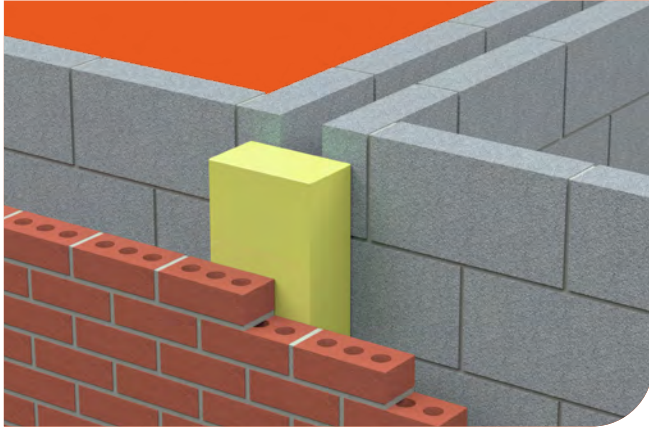

3rd party tested
by Warringtonfire
in accordance with
EN1366-4
principles

USE



- To restrict the spread of smoke and flames within external masonry-masonry cavity walls
- To provide a cavity barrier at party wall junctions
- To minimise heat loss and effect of flanking noise pollution through the cavity wall

- PWFRSTOP cavity stop socks comprise a length of non-combustible mineral wool insulation sleeved in a polythene outer layer for on-site weather protection
- 60 minute fire integrity and insulation performance
- Available to suit cavity widths from 50mm up to 300mm
- Supplied in 1.2m lengths

PRODUCT CODE	TO SUIT CAVITY WIDTH	DIMENSIONS	MIN. COMPRESSION	BAG COLOUR	PALLET QUANTITY
PWFRSTOP50	50mm	65 x 250 x 1200mm	15mm	Yellow	100
PWFRSTOP65	51-65mm	85 x 250 x 1200mm	20mm	Blue	60
PWFRSTOP75	66-75mm	85 x 250 x 1200mm	10mm	Blue	75
PWFRSTOP85	76-85mm	100 x 250 x 1200mm	15mm	Blue	68
PWFRSTOP90	86-90mm	100 x 250 x 1200mm	10mm	Blue	68
PWFRSTOP100	91-100mm	110 x 250 x 1200mm	10mm	Blue	60
PWFRSTOP115	101-115mm	130 x 250 x 1200mm	15mm	Yellow	52
PWFRSTOP125	116-125mm	140 x 250 x 1200mm	15mm	Yellow	48
PWFRSTOP130	126-130mm	150 x 250 x 1200mm	20mm	Yellow	48
PWFRSTOP140	131-140mm	160 x 250 x 1200mm	20mm	Yellow	44
PWFRSTOP150	141-150mm	160 x 250 x 1200mm	10mm	Red	40
PWFRSTOP160	151-160mm	185 x 250 x 1200mm	25mm	Red	36
PWFRSTOP170	161-170mm	195 x 250 x 1200mm	25mm	Red	32
PWFRSTOP180	171-180mm	200 x 250 x 1200mm	20mm	Red	32
PWFRSTOP190	181-190mm	210 x 250 x 1200mm	20mm	Red	32
PWFRSTOP200	191-200mm	220 x 250 x 1200mm	20mm	Red	28
PWFRSTOP210	201-210mm	230 x 250 x 1200mm	20mm	Blue	28
PWFRSTOP220	211-220mm	240 x 250 x 1200mm	20mm	Blue	28
PWFRSTOP230	221-230mm	250 x 250 x 1200mm	20mm	Blue	24
PWFRSTOP240	231-240mm	260 x 250 x 1200mm	20mm	Blue	24
PWFRSTOP250	241-250mm	270 x 250 x 1200mm	20mm	Blue	24
PWFRSTOP260	251-260mm	280 x 250 x 1200mm	20mm	Blue	24
PWFRSTOP270	261-270mm	290 x 250 x 1200mm	20mm	Blue	24
PWFRSTOP280	271-280mm	300 x 250 x 1200mm	20mm	Blue	20
PWFRSTOP290	281-290mm	310 x 250 x 1200mm	20mm	Blue	20
PWFRSTOP300	291-300mm	320 x 250 x 1200mm	20mm	Blue	20

NB. Pallet quantities may vary slightly from the values stated above. Contact sales@timloc.co.uk for confirmation. Bag colour may vary.

PWTIMFRSTOP

60-MINUTE FIRE-RATED PARTY WALL CAVITY STOP SOCK FOR TIMBER-MASONRY

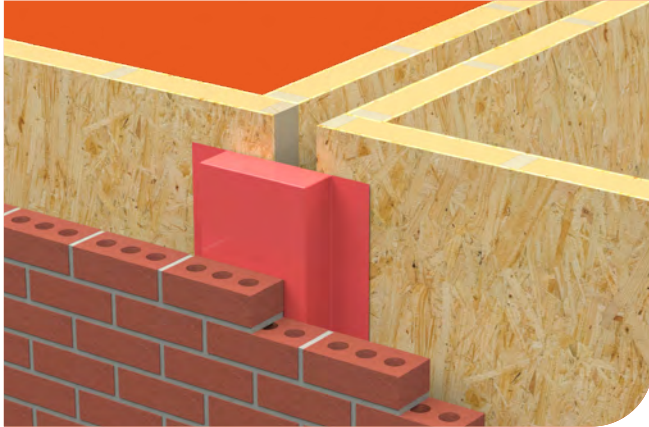

3rd party tested
by Warringtonfire
in accordance with
EN1366-4
principles

USE



- To restrict the spread of smoke and flames within external timber-masonry cavity walls
- To provide a cavity barrier at party wall junctions
- To minimise heat loss and effect of flanking noise pollution through the cavity wall

- PWTIMFRSTOP cavity stop socks comprise a length of non-combustible mineral wool insulation sleeved in a polythene outer layer for on-site weather protection
- 60 minute fire integrity and insulation performance
- Available to suit cavity widths from 50mm up to 150mm
- Supplied in 1.2m lengths

PRODUCT CODE	TO SUIT CAVITY WIDTH	DIMENSIONS	MIN. COMPRESSION	BAG COLOUR	PALLET QUANTITY
PWTIMFRSTOP50	50mm	65 x 250 x 1200mm	15mm	Red	80
PWTIMFRSTOP65	51-65mm	85 x 250 x 1200mm	20mm	Red	60
PWTIMFRSTOP75	66-75mm	85 x 250 x 1200mm	10mm	Red	60
PWTIMFRSTOP85	76-85mm	100 x 250 x 1200mm	15mm	Red	68
PWTIMFRSTOP90	86-90mm	100 x 250 x 1200mm	10mm	Red	68
PWTIMFRSTOP100	91-100mm	110 x 250 x 1200mm	10mm	Red	60
PWTIMFRSTOP115	101-115mm	130 x 250 x 1200mm	15mm	Red	52
PWTIMFRSTOP125	116-125mm	140 x 250 x 1200mm	15mm	Red	48
PWTIMFRSTOP130	126-130mm	140 x 250 x 1200mm	10mm	Red	48
PWTIMFRSTOP140	131-140mm	150 x 250 x 1200mm	10mm	Red	44
PWTIMFRSTOP150	141-150mm	160 x 250 x 1200mm	10mm	Red	40

NB. Pallet quantities may vary slightly from the values stated above. Contact sales@timloc.co.uk for confirmation. Bag colour may vary.



ACCESS PRODUCTS

Plastic, metal and fire rated loft doors and access panels

LOFTITE HINGED DROP DOWN LOFT DOOR	56
PUSH-UP PLASTIC LOFT DOOR	58
PLASTIC HINGED DROP DOWN LOFT DOOR	58
Z-SERIES 1 HOUR FIRE-RATED METAL LOFT DOOR	59
LOFT-LOC LOFT DOOR POLES	59
PLASTIC ACCESS PANELS	60
AIRTIGHT PLASTIC ACCESS PANELS	60
Z-SERIES METAL ACCESS PANELS	61
METAL 1 HOUR FIRE-RATED ACCESS PANELS	61

**SCAN TO VIEW
THE RANGE ONLINE**



OPEN UP TO THE FUTURE



SCAN TO VIEW
THE RANGE ONLINE



3x U-VALUE OPTIONS
AVAILABLE:



0.35 W/m²K



0.25 W/m²K



0.15 W/m²K

Pre-assembled **hinged drop down loft access door** designed to be easy to install and for convenient through-ceiling access to loft spaces.



**EXCEEDS BUILDING
REGULATIONS PART L1 &
L2 FOR AIRTIGHTNESS**



**TWO SEPARATE AIR
SEALS FOR MAXIMIZING
AIRTIGHTNESS**



**KEY LOCK OPTION
ALSO AVAILABLE**



**FITTING SLOTS FOR AN
EASY, SINGLE PERSON
INSTALLATION**



**AVAILABLE ON OUR
FREE NEXT DAY
DELIVERY**

**PATENT
PENDING
EASY FIT SLOT**

LOFT DOORS

Timloc loft doors are designed to be easy-to-install and provide easy through-ceiling access into the loft space, as well as insulation and draft proofing around the opening in a ceiling.



Loftite arrives pre-assembled and ready to fit, featuring a precision-engineered frame with an insulated door mounted on stainless steel hinge pins. Dual air seals ensure exceptional airtightness, while twin catches provide a secure and reliable fit.

Designed for easy, single-person installation, Loftite includes fitting slots, neat hinge caps, and requires no maintenance or painting. It offers a maximised open access area to allow easy and unobstructed entry to the loft space and is fully compatible with most loft ladders.

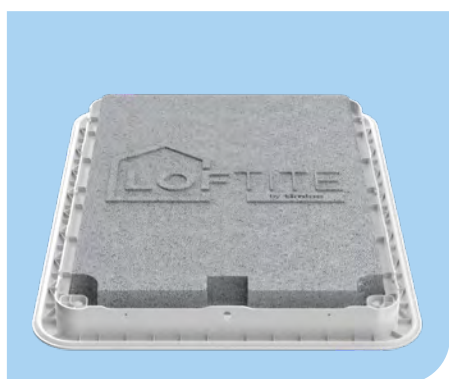

LT0035

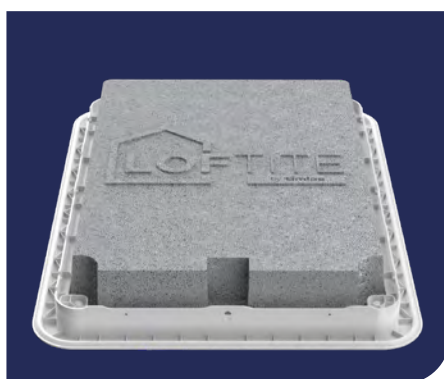

LT0025

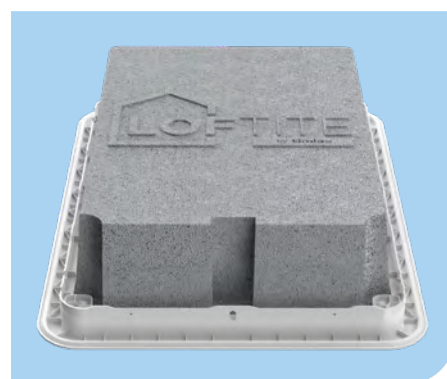

LT0015

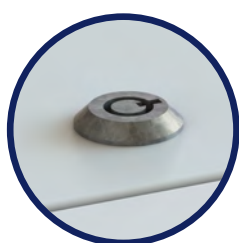

KEY LOCK OPTION
ALSO AVAILABLE



- As standard the U-0.35 insulation option helps to meet the requirements of the Robust Construction Detail.
- The U-0.25 and U-0.15 options help to achieve the higher performance levels required by the Code for Sustainable Homes and the Future Homes Standard.
- Meets and exceeds the requirements of The Building Regulations Approved Document L1 & L2 for airtightness.
- Independently performance tested by BRE for airtightness to BS EN 13141-1 2019 and BS 5250 2021.
- Helps to reduce acoustic noise transmission between the ceiling and loft space.

DESCRIPTION	FRAME FITTING SIZE	CLEAR OPENING SIZE	INSULATION U-VALUE	INSULATION DEPTH	PRODUCT CODES	LEAD TIME
Loftite Hinged Drop Down Loft Door	560 x 740mm	522 x 704mm	0.15 W/m ² K	185mm	LT0015	Next Working Day
Loftite Hinged Drop Down Loft Door with key lock	560 x 740mm	522 x 704mm	0.15 W/m ² K	185mm	LT0015KL	Next Working Day
Loftite Hinged Drop Down Loft Door	560 x 740mm	522 x 704mm	0.25 W/m ² K	110mm	LT0025	Next Working Day
Loftite Hinged Drop Down Loft Door with key lock	560 x 740mm	522 x 704mm	0.25 W/m ² K	110mm	LT0025KL	Next Working Day
Loftite Hinged Drop Down Loft Door	560 x 740mm	522 x 704mm	0.35 W/m ² K	75mm	LT0035	Next Working Day
Loftite Hinged Drop Down Loft Door with key lock	560 x 740mm	522 x 704mm	0.35 W/m ² K	75mm	LT0035KL	Next Working Day



PUSH-UP PLASTIC LOFT DOOR



USE

- Push-up loft door designed to provide easy through-ceiling access into the loft space
- Ready to fit straight out of the box with two twist-operated catches to secure the door in place
- Available in 3 U-value options

PRODUCT CODE	FRAME FITTING SIZE	CLEAR OPENING SIZE	INSULATION U-VALUE	PACK QUANTITY	LEAD TIME
1168	562 x 665mm	526 x 626mm	0.82 W/m ² k	1	Next Working Day
1168/35	562 x 665mm	526 x 626mm	0.35 W/m ² k	1	Next Working Day
1168/25	562 x 665mm	526 x 626mm	0.25 W/m ² k	1	Next Working Day

HINGED PLASTIC LOFT DOOR



USE

- Hinged drop-down loft door designed to provide easy through-ceiling access into the loft space
- Ready to fit straight out of the box with a twist-operated catch to secure the door in place
- Available in 3 U-values and key lock options



PRODUCT CODE	KEY LOCK	FRAME FITTING SIZE	CLEAR OPENING SIZE	INSULATION U-VALUE	PACK QUANTITY	LEAD TIME
1169	No	562 x 662mm	526 x 626mm	0.82 W/m ² k	1	Next Working Day
1169KL	Yes	562 x 662mm	526 x 626mm	0.82 W/m ² k	1	Next Working Day
1169/35	No	562 x 662mm	526 x 626mm	0.35 W/m ² k	1	Next Working Day
1169/35KL	Yes	562 x 662mm	526 x 626mm	0.35 W/m ² k	1	Next Working Day
1169/25	No	562 x 662mm	526 x 626mm	0.25 W/m ² k	1	Next Working Day
1169/25KL	Yes	562 x 662mm	526 x 626mm	0.25 W/m ² k	1	Next Working Day

Z-SERIES



BUDGET LOCK

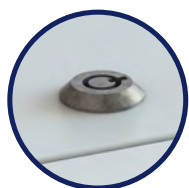

KEY LOCK

1-HOUR FIRE-RATED METAL LOFT DOOR

USE

- Hinged metal loft door for use where fire protection is required
- Twist operated catch to release a hinged, downward opening door. Available in 2 lock options and 2 insulation u-values

Determine the required product by using the table below:

LOCK TYPE		U-VALUE	
		0.82 W/m ² k	0.35 W/m ² k
BUDGET LOCK	Z800...	Z800...	Z900...
	KEY LOCK	ZKL800...	ZKL900...

BUDGET LOCK CODE	KEY LOCK CODE	FRAME FITTING SIZE	CLEAR OPENING SIZE	OVERALL FRAME SIZE	INSULATION U-VALUE	PACK QUANTITY	LEAD TIME
Z8001	ZKL8001	555 x 555mm	528 x 500mm	598 x 598mm	0.82 W/m ² k	1	Next Working Day
Z8002	ZKL8002	560 x 805mm	533 x 750mm	603 x 848mm	0.82 W/m ² k	1	Next Working Day
Z8003	ZKL8003	542 x 630mm	520 x 580mm	590 x 680mm	0.82 W/m ² k	1	Next Working Day
Z8004	ZKL8004	542 x 745mm	520 x 695mm	590 x 795mm	0.82 W/m ² k	1	Next Working Day
Z8005	ZKL8005	605 x 605mm	578 x 550mm	648 x 648mm	0.82 W/m ² k	1	Next Working Day
Z8006	ZKL8006	605 x 905mm	578 x 850mm	648 x 948mm	0.82 W/m ² k	1	Next Working Day
Z8007*	ZKL8007*	905 x 605mm	850 x 578mm	948 x 648mm	0.82 W/m ² k	1	Next Working Day
Z8008*	ZKL8008*	1205 x 605mm	1178 x 550mm	1248 x 648mm	0.82 W/m ² k	1	Next Working Day

BUDGET LOCK CODE	KEY LOCK CODE	FRAME FITTING SIZE	CLEAR OPENING SIZE	OVERALL FRAME SIZE	INSULATION U-VALUE	PACK QUANTITY	LEAD TIME
Z9001	ZKL9001	555 x 555mm	528 x 500mm	598 x 598mm	0.35 W/m ² k	1	Next Working Day
Z9002	ZKL9002	560 x 805mm	533 x 750mm	603 x 848mm	0.35 W/m ² k	1	Next Working Day
Z9003	ZKL9003	542 x 630mm	520 x 580mm	590 x 680mm	0.35 W/m ² k	1	Next Working Day
Z9004	ZKL9004	542 x 745mm	520 x 695mm	590 x 795mm	0.35 W/m ² k	1	Next Working Day
Z9005	ZKL9005	605 x 605mm	578 x 550mm	648 x 648mm	0.35 W/m ² k	1	Next Working Day
Z9006	ZKL9006	605 x 905mm	578 x 850mm	648 x 948mm	0.35 W/m ² k	1	Next Working Day
Z9007*	ZKL9007*	905 x 605mm	850 x 578mm	948 x 648mm	0.35 W/m ² k	1	Next Working Day
Z9008*	ZKL9008*	1205 x 605mm	1178 x 550mm	1248 x 648mm	0.35 W/m ² k	1	Next Working Day

*Hinged on long side

LOFT-LOC LOFT DOOR POLES

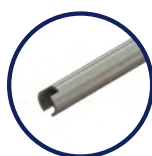

Z1170 SLOTTED KEY

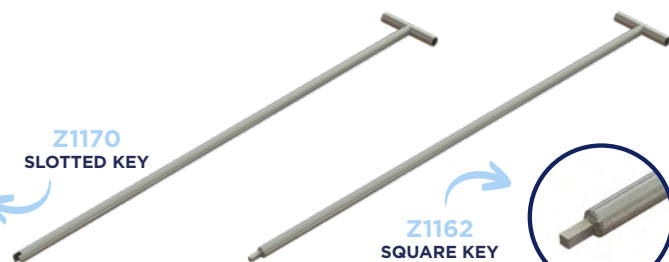

Z1162 SQUARE KEY



PRODUCT CODE	DESCRIPTION	USE	DIMENSIONS	PACK QUANTITY	LEAD TIME
Z1162	Square T-Key	Metal Hinged Loft Access Door	600 x 12 x 75mm	1	Next Working Day
Z1170	Slotted	Plastic Push-Up or Hinged Loft Access Door	600 x 12 x 75mm	1	Next Working Day

ACCESS PANELS

PLASTIC ACCESS PANELS



USE

- Solution for providing access to services and connections behind dry lined walls, ducts, cupboards and ceilings (ex. AP450 & AP450KL)
- Ideal for meeting gas safety industry and Building Regulation Part J's concealed boiler flue inspection access requirements (non-fire rated applications)



PRODUCT CODE	DOOR TYPE	KEY LOCK	FRAME FITTING SIZE	CLEAR OPENING SIZE	OVERALL FRAME SIZE	PACK QUANTITY	LEAD TIME
AP110	Clip fit	No	115 x 165mm	100 x 150mm	135 x 185mm	1	Next Working Day
AP150	Hinged	No	155 x 235mm	140 x 220mm	195 x 275mm	1	Next Working Day
AP200	Clip fit	No	205 x 205mm	190 x 190mm	245 x 245mm	1	Next Working Day
AP300	Hinged	No	305 x 305mm	290 x 290mm	345 x 345mm	1	Next Working Day
AP450*	Hinged	No	470 x 470mm	455 x 455mm	510 x 510mm	1	Next Working Day
AP150KL	Hinged	Yes	155 x 235mm	140 x 220mm	195 x 275mm	1	Next Working Day
AP300KL	Hinged	Yes	305 x 305mm	290 x 290mm	345 x 345mm	1	Next Working Day
AP450KL*	Hinged	Yes	470 x 470mm	455 x 455mm	510 x 510mm	1	Next Working Day

*Not suitable for ceiling installations



Airtight seal reduces air permeability to 0.00/h.m at +50pa

AIRTIGHT PLASTIC ACCESS PANELS

USE

- Solution for providing access to services and connections behind dry lined walls, ducts, cupboards and ceilings
- Ideal for meeting gas safety industry and Building Regulation Part J's concealed boiler blue inspection access requirements (non-fire rated applications)

Helps to meet the requirements of:

- **Building Regulation Part L1 & L2** - Conservation of Fuel and Power (air leakage)
- **Building Regulation Part J** - Heat Producing Appliances (concealed boiler flue inspection access)
- **Building Regulation Part E** - Resistance to Sound

PRODUCT CODE	FRAME FITTING SIZE	CLEAR OPENING SIZE	OVERALL FRAME SIZE	DOOR TYPE	PACK QUANTITY	LEAD TIME
AP110AT	115 x 165mm	100 x 150mm	135 x 185mm	Clip fit	1	Next Working Day
AP150AT	155 x 235mm	140 x 220mm	195 x 275mm	Clip fit	1	Next Working Day
AP200AT	205 x 205mm	190 x 190mm	245 x 245mm	Clip fit	1	Next Working Day
AP300AT	305 x 305mm	290 x 290mm	345 x 345mm	Clip fit	1	Next Working Day
AP450AT	470 x 470mm	455 x 455mm	510 x 510mm	Clip fit	1	Next Working Day

Z-SERIES METAL ACCESS PANELS

USE

- To provide access to services and connections
- For applications where plastic access panels are not suitable and a fire rating is not required
- Ideal for meeting the gas safety industry and Building Regulation Part J's concealed boiler flue inspection access requirements (non-fire rated applications)



PRODUCT CODE	FRAME FITTING SIZE	CLEAR OPENING SIZE	OVERALL PANEL & FRAME SIZE	PACK QUANTITY	LEAD TIME
Z2001	155 x 155mm	128 x 110mm	198 x 198mm	1	Next Working Day
Z2002	155 x 235mm	110 x 208mm	198 x 278mm	1	Next Working Day
Z2003	205 x 205mm	178 x 160mm	248 x 248mm	1	Next Working Day
Z2004	305 x 305mm	278 x 260mm	348 x 348mm	1	Next Working Day
Z2005	355 x 355mm	328 x 310mm	398 x 398mm	1	Next Working Day
Z2006	455 x 455mm	428 x 410mm	498 x 498mm	1	Next Working Day
Z2007	555 x 555mm	528 x 518mm	598 x 598mm	1	Next Working Day
Z2008	605 x 305mm	578 x 260mm	648 x 348mm	1	Next Working Day
Z2009	605 x 605mm	578 x 560mm	648 x 648mm	1	Next Working Day



METAL 1-HOUR FIRE-RATED ACCESS PANELS

USE

- Provides access to services and connections behind dry lined walls and ceilings where a 1-hour fire rating is required
- Projects requiring additional reduced air leakage and/or acoustic performance requirements
- Ideal solution for meeting Part J and the gas safety industry's concealed boiler flue inspection access requirements (1 hour fire-rated applications)

PRODUCT CODE	FRAME FITTING SIZE	CLEAR OPENING SIZE	OVERALL FRAME SIZE	DOOR TYPE	PACK QUANTITY	LEAD TIME
APC150x150CR	155 x 155mm	110 x 110mm	200 x 200mm	T-key lock	1	Next Working Day
APC150x230CR	155 x 235mm	110 x 190mm	200 x 280mm	T-key lock	1	Next Working Day
APC200x200CR	205 x 205mm	160 x 160mm	250 x 250mm	T-key lock	1	Next Working Day
APC300x300CR	305 x 305mm	260 x 260mm	350 x 350mm	T-key lock	1	Next Working Day
APC450x450CR	455 x 455mm	410 x 410mm	500 x 500mm	T-key lock	1	Next Working Day
APC550x550CR	555 x 555mm	510 x 510mm	600 x 600mm	T-key lock	1	Next Working Day
APC600x600CR	605 x 605mm	560 x 560mm	650 x 650mm	T-key lock	1	Next Working Day
APC150x150CRKCL	155 x 155mm	110 x 110mm	200 x 200mm	Key lock	1	Next Working Day
APC150x230CRKCL	155 x 235mm	110 x 190mm	200 x 280mm	Key lock	1	Next Working Day
APC200x200CRKCL	205 x 205mm	160 x 160mm	250 x 250mm	Key lock	1	Next Working Day
APC300x300CRKCL	305 x 305mm	260 x 260mm	350 x 350mm	Key lock	1	Next Working Day
APC450x450CRKCL	455 x 455mm	410 x 410mm	500 x 500mm	Key lock	1	Next Working Day
APC550x550CRKCL	555 x 555mm	510 x 510mm	600 x 600mm	Key lock	1	Next Working Day
APC600x600CRKCL	605 x 605mm	560 x 560mm	650 x 650mm	Key lock	1	Next Working Day

RAD-SEAL

by **timloc**

RADIATOR PIPE GUIDE & SEALS

Rad-Seal is the effective **radiator pipe guide and seal** designed to help reduce air leakage in homes. Rad-Seal is available in two options: Rad-Seal Recessed and Rad-Seal Face-Fix.



SCAN TO VIEW
THE RANGE ONLINE



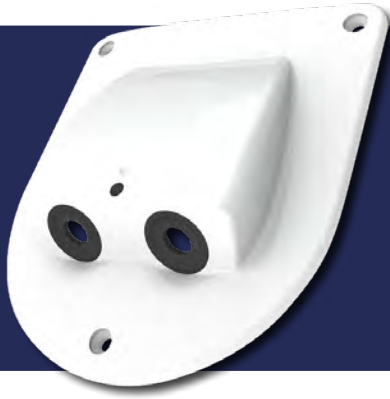

RAD-SEAL 10



Face-fix radiator pipe guide and seal for 10mm pipework.

PRODUCT CODE	HEIGHT	WIDTH	DEPTH	PACK QUANTITY	LEAD TIME
2221	140mm	126mm	23.5mm	20	Next Working Day

RAD-SEAL 15



Face-fix radiator pipe guide and seal for 15mm pipework.

PRODUCT CODE	HEIGHT	WIDTH	DEPTH	PACK QUANTITY	LEAD TIME
2222	140mm	126mm	23.5mm	20	Next Working Day



RAD-SEAL RECESSED

Recessed radiator pipe guide and seal for 10mm pipework.

PRODUCT CODE	DIAMETER	DEPTH	PACK QUANTITY	LEAD TIME
1115	140mm	5mm	10	Next Working Day



EVERYTHING UNDER ONE ROOF

The Roofline by Timloc range encompasses the ancillary products required within a roofing application. Products range from ventilation systems for roofs, eaves and soffits to one-kit solutions for dry ridge and hip installations.

VENTILATION	66
LEAD-FREE FLASHING	71
RIDGE & HIP KITS	72
DRY VERGE	75
SOAKERS	78
ROOF TILE & SLATE VENTS	80



**SCAN TO VIEW
THE RANGE ONLINE**



ROOFLINE

by **timloc**



VENTILATION

ALLOWING ROOFS TO BREATHE

Ventilation is important, it helps to mitigate condensation, regulate moisture levels, and maintain thermal balance. Continuous circulation helps protect structural timbers, insulation and internal finishes from long-term damage caused by trapped heat or humidity. Our comprehensive range of roof ventilation, ancillary and dry fix installation solutions is engineered to meet industry standards, providing the assurance of proven quality, reliability and durability.

PUSH-IN SOFFIT VENT

USE

- For roof eaves ventilation
- For remedial work on existing roofs
- On roofs where the eaves incorporate a soffit board
- On roofs requiring ventilation equivalent to a 10mm continuous opening



PRODUCT CODE	COLOUR	FREE AIRFLOW	PACK QUANTITY	LEAD TIME
1139	Grey	10,000mm ²	10	Next Working Day
1140	White	10,000mm ²	10	Next Working Day
1141	Black	10,000mm ²	10	Next Working Day
1142	Brown	10,000mm ²	10	Next Working Day



SOFFIT VENT STRIP

USE

- For roof eaves ventilation
- On roofs where the eaves incorporate a soffit board
- With soffit boards of between 6mm and 9mm in thickness

PRODUCT CODE	LENGTH	COLOUR	FREE AIRFLOW	PACK QUANTITY	LEAD TIME
1137WH	2.4m	White	10,000mm ²	10	Next Working Day
1137BR	2.4m	Brown	10,000mm ²	10	Next Working Day
1137BL	2.4m	Black	10,000mm ²	10	Next Working Day
1138WH	2.4m	White	25,000mm ²	10	Next Working Day
1138BR	2.4m	Brown	25,000mm ²	10	Next Working Day

2-IN-1/3-IN-1 EAVES VENT



USE

- For roof eaves ventilation
- On roofs where the eaves incorporate a fascia board
- On roofs which do not incorporate a soffit board or where an unbroken soffit board is required

PRODUCT CODE	EAVES COMB	FREE AIRFLOW	LENGTH	PACK QUANTITY	LEAD TIME
3014	No	10,000mm ²	1m	20	Next Working Day
3014C	Yes	10,000mm ²	1m	10	Next Working Day

FELT SUPPORT TRAY

USE

- At the eaves of a roof to support and protect roofing felt
- For remedial work to replace worn or perished roofing felt



PRODUCT CODE	LENGTH	PACK QUANTITY	LEAD TIME
3017	1500mm	10	Next Working Day
1128	600mm	20	Next Working Day

PRODUCT CODE	LENGTH	PALLET QUANTITY	LEAD TIME
4017	1500mm	1000 Unbagged	Next Working Day



EAVES BIRD COMB FILLER

USE

- At the eaves of a roof
- Below profiled roof tiles to exclude birds and vermin

PRODUCT CODE	LENGTH	DEPTH OF COMB	PACK QTY	LEAD TIME
1136	1m	55mm	50	Next Working Day



All of our ventilation products are designed with ease of installation in mind, ensuring quick, straightforward fitting without compromising on performance.

Scan the QR code to view the installation advice.

300MM OVER FASCIA VENT

USE

- For roof eaves ventilation
- For flat roof abutment ventilation
- On roofs where the eaves incorporate a fascia board
- On roofs which do not incorporate a soffit board, or where an unbroken soffit board is required



PRODUCT CODE	FREE AIRFLOW	LENGTH	COLOUR	PACK QUANTITY	LEAD TIME
3011BL	10,000mm ²	300mm	Black	10	Next Working Day
3011WH	10,000mm ²	300mm	White	10	Next Working Day
3011/25BL	25,000mm ²	300mm	Black	10	Next Working Day
3011/25WH	25,000mm ²	300mm	White	10	Next Working Day



1M OVER FASCIA VENT

USE

- For roof eaves ventilation
- For flat roof abutment ventilation
- On roofs where the eaves incorporate a fascia board
- On roofs which do not incorporate a soffit board, or where an unbroken soffit board is required

PRODUCT CODE	COLOUR	FREE AIRFLOW	LENGTH	PACK QUANTITY	LEAD TIME
OF1BL	Black	10,000mm ²	1m	25	Next Working Day
OF2BL	Black	25,000mm ²	1m	20	Next Working Day

CORBEL VENT

USE

- For roof eaves ventilation
- On roofs where ventilation equivalent to a continuous 10mm opening is required
- On roofs where the eaves are corbelled masonry finish
- On roofs which do not incorporate a soffit board or fascia board



PRODUCT CODE	LENGTH	FREE AIRFLOW	PACK QUANTITY	LEAD TIME
3012	2.4m	10,000mm ² per metre	10	Next Working Day

ENGINEERED FOR EFFICIENCY



RAFTER ROLL

USE

- For pitched roof eaves ventilation
- On standard pitched roofs where the pitch is 15° or more and the roof void is an attic or loft space
- On roofs with rafter spacings between 400mm and 600mm centres

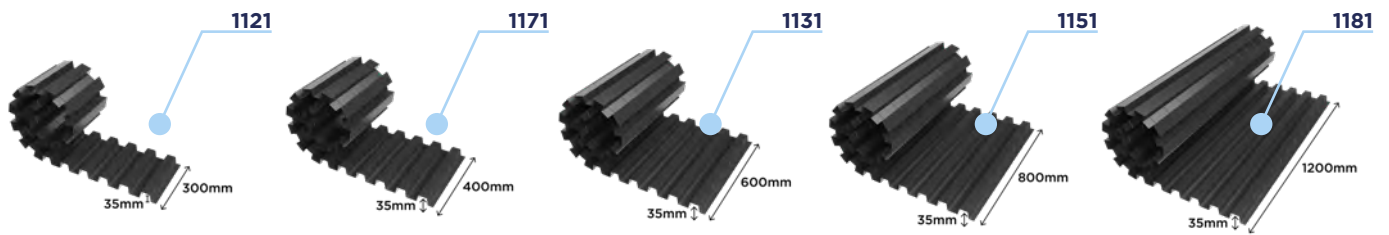

PRODUCT CODE	LENGTH	WIDTH	PACK QUANTITY	LEAD TIME
1121	6m	300mm	10	Next Working Day
1171	6m	400mm	12	Next Working Day
1131	6m	600mm	5	Next Working Day
1151	6m	800mm	6	Next Working Day
1181	6m	1200mm	5	Next Working Day

6M EAVES VENT PACK

USE

- For pitched roof eaves ventilation
- On standard pitched roofs
- On roofs with rafter spacings of between 400mm and 600mm



1 x Rafter Roll (300mm or 600mm width) | 6 x 1m Over Fascia Vent (10,000mm² or 25,000mm² airflow) | 10 x Felt Support Tray (600mm)

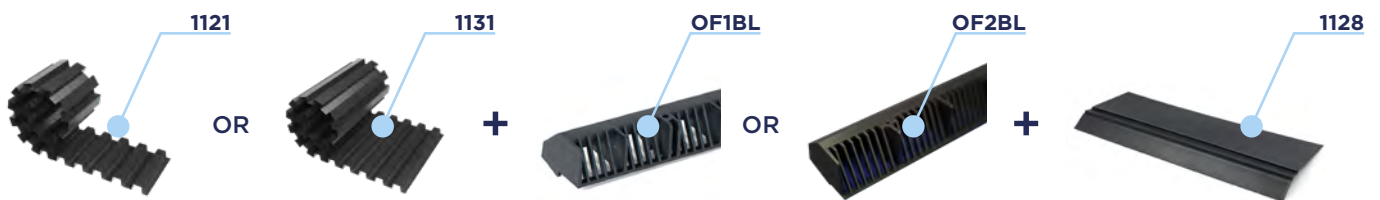

PRODUCT CODE	FREE AIRFLOW	ROLL FORM VENT WIDTH	LEAD TIME
EVP6	10,000mm ²	300mm	Next Working Day
EVP6/25	25,000mm ²	300mm	Next Working Day
EVP6/600	10,000mm ²	600mm	Next Working Day
EVP6/25600	25,000mm ²	600mm	Next Working Day

Cooler temperatures increase the risk of

CONDENSATION

in the loft space



SOLVE IT
with

LAP VENT

A remedial solution for combating condensation in cold roof voids by separating lap joints in the roofing felt/membrane and can be fitted retrospectively after increased loft insulation.



PRODUCT CODE

5560

FREE AIRFLOW

3,000mm²

PACK QUANTITY

10

LEAD TIME

Next Working Day

82

Pb FREE

LEAD-FREE FLASHING

USE

- Same applications as traditional lead flashing including flat roof connection, dormers, valley gutters, step and cover flashing, cavity walls and apron flashing
- Can be used in any climate worldwide (-40°C/+90°C)

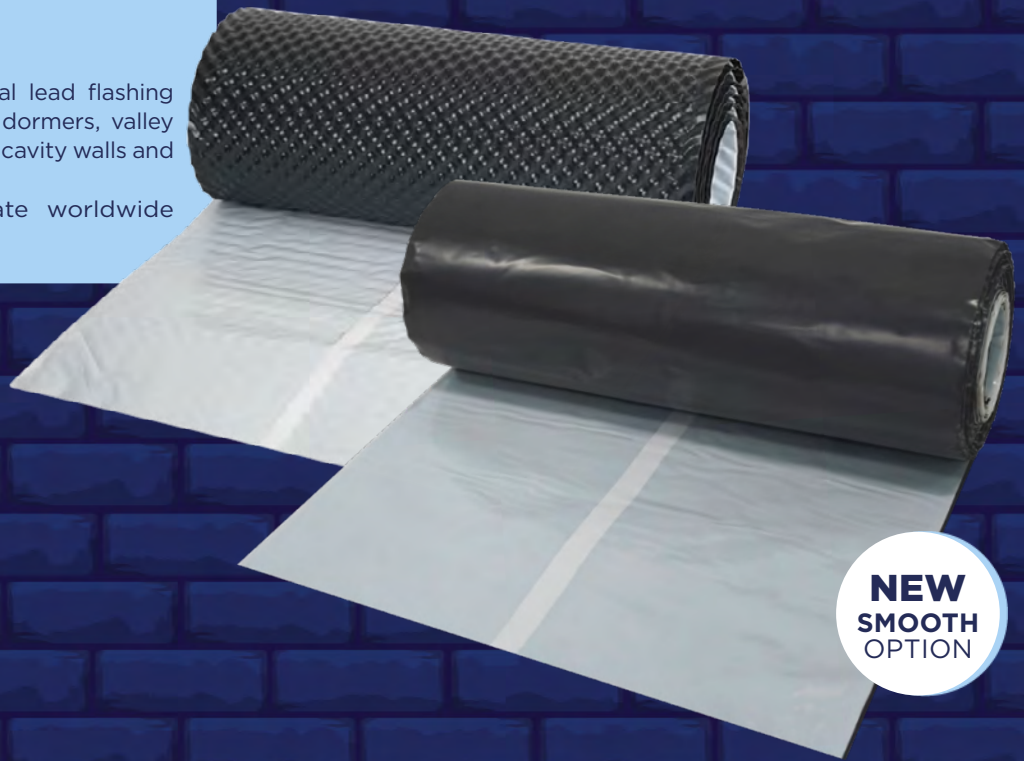

**NEW
SMOOTH
OPTION**



The lead alternative, high-performance aluminium flashing. For the same applications as traditional lead flashing including flat roof connection, dormers, valley gutters, step and cover flashing, cavity walls and apron flashing.

PRODUCT CODE	DESCRIPTION	ROLL WIDTH	LENGTH	PACK QUANTITY	LEAD TIME
LF150	PbFree Lead-free Flashing	150mm	5m	1	Next Working Day
LF300	PbFree Lead-free Flashing	300mm	5m	1	Next Working Day
LF450	PbFree Lead-free Flashing	450mm	5m	1	Next Working Day
SLF150	Smooth PbFree Lead-free Flashing	150mm	5m	1	Next Working Day
SLF300	Smooth PbFree Lead-free Flashing	300mm	5m	1	Next Working Day
SLF450	Smooth PbFree Lead-free Flashing	450mm	5m	1	Next Working Day

DRY FIX RIDGE KITS



**DRY FIX
RIDGE KIT**

For use with most types of slate, concrete or clay roof ridge tiles on roof pitches between 15-55°. The ridge union has adjustable clips positions compatible with ridge tiles up to 30mm thickness.

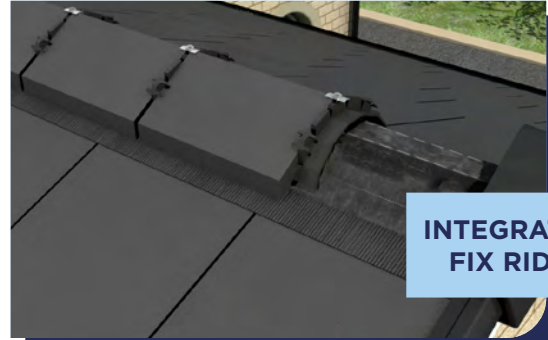

**INTEGRATED DRY
FIX RIDGE KIT**

For use with most types of slate, concrete or clay roof ridge tiles on roof pitches between 15-55°. The ridge union has integrated clips compatible with ridge tiles up to 18mm thickness.

DRY FIX RIDGE KIT

USE

- Most types of slate, concrete or clay roof tiles
- Round or angled ridge tiles
- Most pitched roof types from 15-55°
- New build and retro-fit projects

6M PACK:

- 1 x 6m ridge roll with self-adhesive flashing*
- 13 x fixing screws, washers and clamping plates*
- 13 x ridge unions
- 26 x ridge clips
- 10 x ridge batten straps



10M PACK:

- 1 x 10m ridge roll with self-adhesive flashing*
- 26 x fixing screws, washers and clamping plates*
- 26 x ridge unions
- 52 x ridge clips
- 20 x ridge batten straps

PRODUCT CODE	DESCRIPTION	COLOUR	LEAD TIME
54700	6m Dry Fix Ridge Kit	Black	Next Working Day
51700	10m Dry Fix Ridge Kit	Black	Next Working Day

* Please note, roll flashing and clamping plate colours may vary.

**INTEGRATED
RIDGE CLIPS**
for easy
installation



INTEGRATED DRY FIX RIDGE KIT

USE

- Most types of slate, concrete or clay roof tiles
- Round or angled ridge tiles
- Most pitched roof types from 15-55°
- New build and retro-fit projects

3M PACK:

- 1 x** 3m ridge roll with self-adhesive flashing*
- 7 x** fixing screws, washers and clamping plates*
- 7 x** ridge unions with integrated clips
- 5 x** ridge batten straps

6M PACK:

- 1 x** 6m ridge roll with self-adhesive flashing*
- 13 x** fixing screws, washers and clamping plates*
- 13 x** ridge unions with integrated clips
- 10 x** ridge batten straps

PRODUCT CODE	DESCRIPTION	COLOUR	LEAD TIME
53700	3m Integrated Dry Fix Ridge Kit	Black	Next Working Day
54703	6m Integrated Dry Fix Ridge Kit	Black	Next Working Day

* Please note, roll flashing and clamping plate colours may vary.

DRY FIX CLAY RIDGE KIT

USE

- Most types of clay roof tiles
- Round or angled ridge tiles
- Most pitched roof types from 15-55°
- New build and retro-fit projects

PACK CONTAINS:

- 1 x** 6m ridge roll with self-adhesive flashing*
- 20 x** fixing screws, washers and clamping plates*
- 20 x** ridge unions
- 40 x** ridge union clips
- 10 x** ridge batten straps

* Please note, roll flashing and clamping plate colours may vary.



PRODUCT CODE	DESCRIPTION	LEAD TIME
54713	6m Dry Fix Clay Ridge Kit	Next Working Day

NEED SOMETHING EXTRA?



PRODUCT CODE	DESCRIPTION	LEAD TIME
54618	13x ridge unions & 26x ridge clips	Next Working Day
54626	13x fixing screws & clamping plates	Next Working Day

DRY FIX HIP KITS



DRY FIX HIP KIT

USE

- Most types of slate, concrete or clay hip tiles
- Round or angled hip tiles
- Most pitched roof types from 15-55°
- New build and retro-fit projects

PACK CONTAINS:

- 1 x 6m ridge roll with self-adhesive flashing*
- 6 x hip trays
- 13 x fixing screws, washers and clamping plates*
- 13 x ridge unions
- 26 x ridge union clips
- 10 x ridge batten straps

PRODUCT CODE	DESCRIPTION	COLOUR	LEAD TIME
54710	6m Dry Fix Hip Kit	Black	Next Working Day
54618	13 x Ridge Unions & 26 x Ridge Clips	Black	Next Working Day
54626	13 x Fixing Screws & Clamping Plates	N/A	Next Working Day

* Please note, roll flashing and clamping plate colours may vary.

HIP TRAY PACK

USE

- Most types of slate, concrete or clay hip tiles
- Round or angled hip tiles
- Most pitched roof types from 15-55°
- New build and retro-fit projects



PRODUCT CODE	DESCRIPTION	PACK QTY	LEAD TIME
44623	Hip Trays Pack	6	Next Working Day

PRODUCT CODE	DESCRIPTION	PALLET QTY	LEAD TIME
44625	Hip Trays Unbagged	1000	Next Working Day



PRODUCT CODE	DESCRIPTION	LEAD TIME
44630	Top & Tail clips (20x large & 20x small) Kit	Next Working Day

HIP CLIPS KIT

USE

- Most types of slate, concrete or clay hip tiles
- Round or angled hip tiles
- Most pitched roof types from 15-55°
- New build and retro-fit projects

DRY FIX VERGE

UNIVERSAL CAPS & BRACKETS



USE

- With Ambi-Verge, Handed, Interlocking Plain and Thin Leading Edge verge systems from Timloc Building Products.

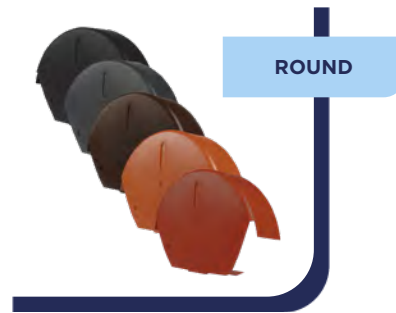
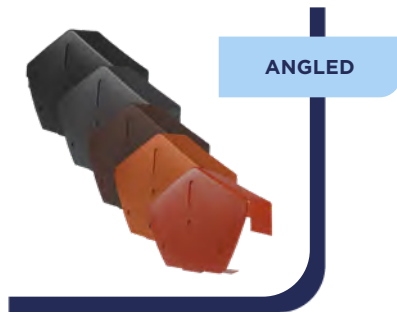

PRODUCT CODE					DESCRIPTION	PACK QUANTITY	LEAD TIME
GREY	BROWN	BLACK	TERRACOTTA	RED			
99109	99108	99107	99110	99183	Universal angled ridge cap	10	Next Working Day
99113	99112	99136	99114	99184	Universal round ridge cap	10	Next Working Day

PRODUCT CODE	DESCRIPTION	PACK QUANTITY	LEAD TIME
99124	Universal end grain batten bracket	20	Next Working Day

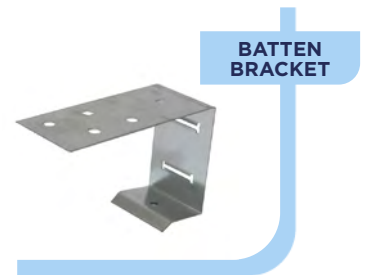

AMBI-VERGE

A universal dry fix verge system for profiled roof tiles is a robust, attractive, and weather-resistant alternative to traditional wet mortar bedding.

USE

- Large format and interlocking concrete profiled tiles
- Most pitched roof types from 15-55°
- Verges with or without bargeboards
- New build and refurbishment projects

PRODUCT CODE				DESCRIPTION	PACK QUANTITY	LEAD TIME
GREY	BROWN	BLACK	TERRACOTTA			
99141	99142	99143	99144	Ambi-Verge dry fix verge piece	20	Next Working Day
99153	99155	99154	99156	Ambi-Verge eaves starter	8	Next Working Day

HANDED DRY FIX VERGE



A premium and weather-resistant verge system alternative to traditional wet mortar bedding. Designed to be strong but flexible for easy flexing and sliding along roof tiles.

USE

- Large format, interlocking concrete and clay profiled tiles
- Batten gauges between 260-345mm
- Most pitched roof types from 15-55°
- Verges with or without bargeboards
- New build and refurbishment projects

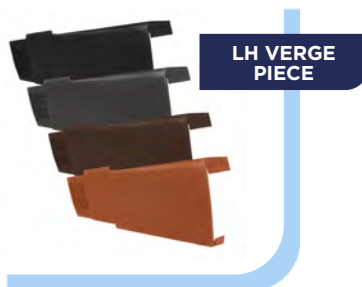

PRODUCT CODE				DESCRIPTION	PACK QUANTITY	LEAD TIME
GREY	BROWN	BLACK	TERRACOTTA			
99117	99116	99137	99118	Dry fix verge right hand piece	20	Next Working Day
99121	99120	99138	99122	Dry fix verge left hand piece	20	Next Working Day
99126	99125	99130	99127	Dry fix verge eaves starter pack (L+R)	1 + 1	Next Working Day



INTERLOCKING PLAIN DRY FIX VERGE

A robust, attractive and weather resistant verge system alternative to wet mortar bedding for Interlocking Plain tiles.

USE

- Developed for Interlocking Plain concrete tiles
- Suitable for most pitched roof types from 15-55°
- Verges with or without bargeboards
- New build and refurbishment projects



PRODUCT CODE					DESCRIPTION	PACK QUANTITY	LEAD TIME
GREY	BROWN	BLACK	TERRACOTTA	RED			
99174	99176	99173	99175	99182	Interlocking Plain verge	40	Next Working Day
99178	99180	99177	99179	99181	Interlocking Plain eaves starter	10	Next Working Day

THIN LEADING EDGE DRY FIX VERGE



USE

- Developed for Thin Leading Edge roof tiles
- Suitable for most pitched roof types from 15-55°
- Verges with or without bargeboards
- New build and refurbishment projects



A robust, attractive and weather resistant verge system alternative to wet mortar bedding for Thin Leading Edge tiles.

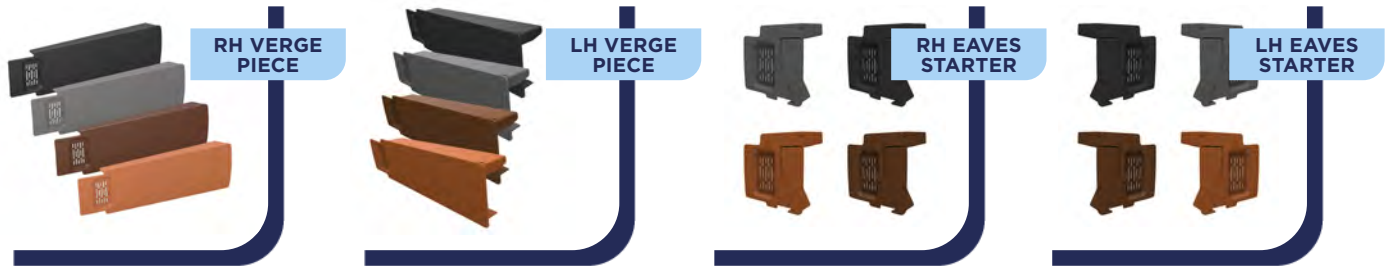

PRODUCT CODE				DESCRIPTION	PACK QUANTITY	LEAD TIME
GREY	BROWN	BLACK	TERRACOTTA			
99158	99160	99157	99159	Thin Leading Edge verge (LH)	20	Next Working Day
99162	99164	99161	99163	Thin Leading Edge verge (RH)	20	Next Working Day
99166	99168	99165	99167	Thin Leading Edge eaves starter (LH)	10	Next Working Day
99170	99172	99169	99171	Thin Leading Edge eaves starter (RH)	10	Next Working Day

A continuous verge system, for slate and flat tiles, that presents a clean flush finish and an effective and virtually maintenance free alternative to wet mortar bedding.



CONTINUOUS DRY FIX VERGE

USE

- Slate and tile thickness between 4 - 13mm slate and slate-effect tiles



PRODUCT CODE	DESCRIPTION	PACK QTY	LEAD TIME
66101	Continuous verge 3m piece - New build	4	Next Working Day
66105	Continuous verge 3m piece - Refurbishment	4	Next Working Day
66120	Continuous Verge angled ridge cap	1	Next Working Day
66117	Continuous verge eaves starter pair (L+R)	1 + 1	Next Working Day
66124	Continuous verge joint union	1	Next Working Day

DRY FIX LEAD REPLACEMENT SOAKERS

Patented 'snip off'
soakers for universal
fixing

Soakers help to prevent any water ingress at the abutment to a wall and provide an aesthetic finish



IT'S A
SNIP



SCAN
FOR VIDEO



Simple on-site installation

Compatibility chart available

Cost-saving Lead alternative

Fitting instructions available

Easy snip tab for universal fixing

UV-protected & colourfast Polypropylene

Comprehensive chart of the compatible soakers available from Timloc Building Products to suit popular roof tiles and slates. **If the tile or slate you are using is not listed please get in touch to discuss compatible options to suit your project requirements.**

CODE	DESCRIPTION	COMPATIBILITY	IMAGE
AS-PLAIN	Plain Tiles	Most Plain tiles from major manufacturers including: • Redland Rosemary • Marley Plain • Russell Traditional Plain • Sandtoft Humber Plain	
AS-INTPLAIN	Interlocking Plain Tiles	Most Interlocking Plain tiles from major manufacturers including: • Marley Ashmore • Redland Duoplain • Forticrete Gemini	
AS-SLATE	Slates	Natural or Synthetic Slates Slate sizes 600mm x 300mm or 500mm x 250mm Product can be trimmed to suit smaller slate sizes if required	
AS-TLE	Thin Leading Edge Tiles	Most Thin Leading Edge large format tiles from major manufacturers including: • Marley Edgemere • Redland Richmond • Sandtoft TLE • Russell Galloway • Lagan Elite	
AS-FLAT	Flat Tiles	Most Flat large format tiles from major manufacturers including: • Marley Modern • Marley Duo Modern • Redland Mini Stonewold • Sandtoft Calderdale • Russell Grampian • Russell Highland • Lagan Flat	

PLAIN



USE

- Traditional Plain Clay Tiles
- Abutments between a pitched roof and a wall
- New build or refurbishment projects

INTERLOCKING PLAIN

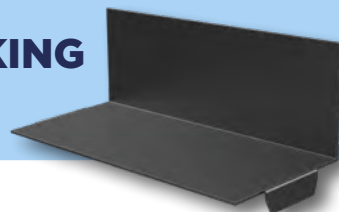

USE

- Interlocking Plain Tiles
- Abutments between a pitched roof and a wall
- New build or refurbishment projects

SLATE

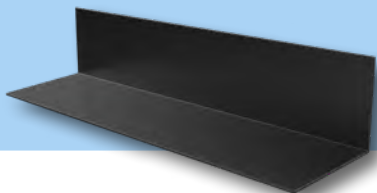

USE

- Natural or Synthetic slates
- Abutments between a pitched roof and a wall
- New build or refurbishment projects

THIN LEADING EDGE

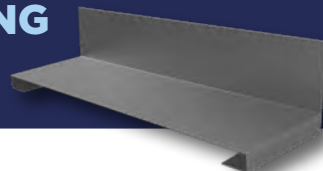

USE

- Thin Leading Edge Tiles
- Abutments between a pitched roof and a wall
- New build or refurbishment projects

FLAT

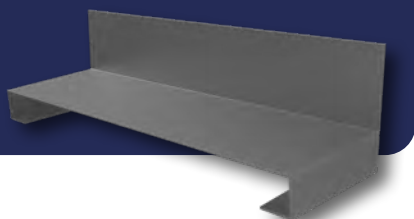

USE

- Large Format Flat Tiles
- Abutments between a pitched roof and a wall
- New build or refurbishment projects



AS

AMBI-SOAKER

PRODUCT CODE	DESCRIPTION	COLOUR	DIMENSIONS (HxLxW)	PACK QUANTITY	LEAD TIME
AS-PLAIN	Plain	Black	80 x 170 x 100mm	50	Next Working Day
AS-INTPLAIN	Interlocking Plain	Black	80 x 240 x 100mm	40	Next Working Day
AS-SLATE	Slate	Black	80 x 400 x 100mm	50	Next Working Day
AS-TLE	Thin Leading Edge	Grey	98.5 x 432 x 125mm	50	Next Working Day
AS-FLAT	Flat	Grey	114 x 432 x 125mm	30	Next Working Day

TRIED. TESTED. TRUSTED.

Timloc Building Products' InVentive range of roof tile and slate vents has successfully undergone BRE testing to PD CEN/TR 15601 for resistance to wind-driven rain, giving further assurance of quality and reliability.

Each test is a thorough evaluation of the vents' impact on roof weather tightness. The results speak for themselves — every vent tested successfully maintained the roof's weatherproof performance, providing proven protection and long-term reliability.



INVENTIVE

Roof ventilation solutions

Available in **single, pack, and pallet** quantities



Designed to suit **popular tile and slate** types

Next day delivery on the entire product range

Tested to PD CEN/TR 15601 against wind driven rain



Full range of **adapters and accessories** available

Comprehensive range of **tile and slate vents** from

timloc
building products

Available Colours: ● Terracotta | TE ● Brown | BR ● Red | RD ● Grey | GR ● Black | BL
 Add the required colour option code to the end of the product code when ordering e.g. RTV-CTE

FP MCCANN

Tile Type	Vent Code	Vent Name	Min. Pitch	Colours
Double Roman	RTV-DR	Double Roman	20°	●●●●●
Square Top	RTV-C	Castellated	20°	●●●●●
Thin Flat Tile	RTV-TE	Thin Leading Edge	20°	●●●●●●●
Duo Thin Flat Tile	RTV-TE	Thin Leading Edge	20°	●●●●●●●

FORTICRETE

Tile Type	Vent Code	Vent Name	Min. Pitch	Colours
Forticrete Gemini	RTV-IP	Interlocking Plain	22.5°	●●●●●
Forticrete V2	RTV-MC	Mini Castellated	17.5°	●●●●●

LAGAN

Tile Type	Vent Code	Vent Name	Min. Pitch	Colours
Lagan Double Roll	RTV-DR	Double Roman	20°	●●●●●
Lagan Elite	RTV-TE	Thin Leading Edge	20°	●●●●●●●
Lagan Flat	RTV-NP	Non-Profile	20°	●●●●●●●
Lagan Square Top	RTV-C	Castellated	20°	●●●●●

MARLEY

Tile Type	Vent Code	Vent Name	Min. Pitch	Colours
Marley Anglia	RTV-SP	Single Pantile	20°	●●●●●
Marley Ashmore	RTV-IP	Interlocking Plain	22.5°	●●●●●
Marley Double Roman	RTV-DR	Double Roman	20°	●●●●●
Marley Duo Modern	RTV-NP	Non-Profile	20°	●●●●●●●
Marley Edgemere	RTV-TE	Thin Leading Edge	20°	●●●●●●●
Marley Ludlow Major	RTV-C	Castellated	20°	●●●●●
Marley Ludlow Plus	RTV-MC	Mini Castellated	17.5°	●●●●●
Marley Mendip	RTV-DP	Double Pantile	20°	●●●●●
Marley Modern	RTV-NP	Non-Profile	20°	●●●●●●●
Marley Plain	RTV-P	Plain	35°	●●●●●
	RTV-LPP	Low Profile Plain		
	RTV-SLIP	Slip Plain		

RUSSELL

Tile Type	Vent Code	Vent Name	Min. Pitch	Colours
Russell Bute	RTV-TE	Thin Leading Edge	20°	●●●●●●●
Russell Cheviot	RTV-C	Castellated	20°	●●●●●
Russell Double Roman	RTV-DR	Double Roman	20°	●●●●●
Russell Galloway	RTV-TE	Thin Leading Edge	20°	●●●●●●●
Russell Grampian	RTV-NP	Non-Profile	20°	●●●●●●●
Russell Highland	RTV-NP	Non-Profile	20°	●●●●●●●
Russell Pennine	RTV-DP	Double Pantile	20°	●●●●●
Russell Traditional Plain	RTV-P	Plain	35°	●●●●●
	RTV-LPP	Low Profile Plain		
	RTV-SLIP	Slip Plain		

If the tile or slate you are using is not listed please get in touch to discuss compatible options to suit your project requirements.

QUINN

Tile Type	Vent Code	Vent Name	Min. Pitch	Colours
Quinn Locherne	RTV-DP	Double Pantile	20°	

REDLAND

Tile Type	Vent Code	Vent Name	Min. Pitch	Colours
Redland 49	RTV-MC	Mini Castellated	17.5°	
Redland 50 Double Roman	RTV-DR	Double Roman	20°	
Redland Duoplain	RTV-IP	Interlocking Plain	22.5°	
Redland Fenland Pantile	RTV-SP	Single Pantile	20°	
Redland Grovebury	RTV-DP	Double Pantile	20°	
Redland Landmark	RTV-DP	Double Pantile	20°	
Redland Mini Stonewold	RTV-NP	Non-Profile	20°	
Redland Renown	RTV-C	Castellated	20°	
Redland Richmond	RTV-TE	Thin Leading Edge	20°	
Redland Rosemary	RTV-P	Plain	35°	
	RTV-LPP	Low Profile Plain		
	RTV-SLIP	Slip Plain		

SANDTOFT

Tile Type	Vent Code	Vent Name	Min. Pitch	Colours
Sandtoft Calderdale Edge	RTV-FE	Flat Edge	20°	
Sandtoft Danum	RTV-FE	Flat Edge	20°	
Sandtoft Double Pantile	RTV-DP	Double Pantile	20°	
Sandtoft Double Roman	RTV-DR	Double Roman	20°	
Sandtoft Calderdale	RTV-NP	Non-Profile	20°	
Sandtoft Lindum	RTV-C	Castellated	20°	
Sandtoft Shire	RTV-SP	Single Pantile	20°	
Sandtoft Standard Pattern	RTV-MC	Mini Castellated	17.5°	
Sandtoft TLE	RTV-TE	Thin Leading Edge	20°	
Sandtoft Humber Plain	RTV-P	Plain	35°	
	RTV-LPP	Low Profile Plain		
	RTV-SLIP	Slip Plain		

SLATE

Slate Type	Vent Code	Vent Name	Min. Pitch	Colours
All major slates (600x300mm or 500x250mm)	RTV-IS	Inline Slate	22.5°	
All major slates in smaller sizes (300x200mm to 400x250mm)	RTV-SIS	Small Inline Slate	22.5°	
All major slates (600x300mm or 500x250mm)	RTV-HS	Hooded Slate	22.5°	
All major slates (600x300mm or 500x250mm)	4001	Universal Slate	22.5°	

UNIVERSAL

Tile or Slate Type	Vent Code	Vent Name	Min. Pitch	Colours
All major plain or profiled tiles or slates	RTV-UNI	Universal	12.5°	
All major plain or profiled tiles or slates	RTV-UNI2	Universal 22,000mm ²	12.5°	

INVENTIVE

Roof ventilation solutions

TILE VENTS

Available in single, multi and pallet quantities
Multi = X vents in 1 box (order as each using multi code)



CASTELLATED

bre



COMPATIBILITY

Castellated large format tiles from all major manufacturers including:

- Marley Ludlow Major
- Redland Renown
- Sandtoft Lindum
- Russell Cheviot
- Lagan Square Top
- FP McCann Square Top

USE

- On roofs with Castellated tiles
- For direct roof space ventilation
- Connected to a ducted ventilation system inside the building



20° min. pitch

10,000mm² free ventilation area

Replaces 1 Castellated tile

UV stabilised PP top

DESCRIPTION	COLOUR	SINGLE CODE	MULTI CODE	MULTI QUANTITY	PALLET QUANTITY	LEAD TIME
Castellated	Terracotta	RTV-CTE	RTVMULTI-CTE	8	136	Next Working Day
Castellated	Brown	RTV-CBR	RTVMULTI-CBR	8	136	Next Working Day
Castellated	Grey	RTV-CGR	RTVMULTI-CGR	8	136	Next Working Day
Castellated	Red	RTV-CRD	RTVMULTI-CRD	8	136	Next Working Day

DOUBLE PANTILE

bre



COMPATIBILITY

Double Pantile large format tiles from all major manufacturers including:

- Marley Mendip
- Redland Grovebury
- Redland Landmark
- Russell Pennine
- Quinn Locherne
- Sandtoft Double Pantile

USE

- On roofs with Double Pantile tiles
- For direct roof space ventilation
- Connected to a ducted ventilation system inside the building



20° min. pitch

10,000mm² free ventilation area

Replaces 1 Double Pantile tile

UV stabilised PP top

DESCRIPTION	COLOUR	SINGLE CODE	MULTI CODE	MULTI QUANTITY	PALLET QUANTITY	LEAD TIME
Double Pantile	Terracotta	RTV-DPTE	RTVMULTI-DPTE	6	102	Next Working Day
Double Pantile	Brown	RTV-DPBR	RTVMULTI-DPBR	6	102	Next Working Day
Double Pantile	Grey	RTV-DPGR	RTVMULTI-DPGR	6	102	Next Working Day
Double Pantile	Red	RTV-DPRD	RTVMULTI-DPRD	6	102	Next Working Day

DOUBLE ROMAN

bre



COMPATIBILITY

Double Roman large format tiles from all major manufacturers including:

- Marley Double Roman
- Redland 50 Double Roman
- Russell Double Roman
- Sandtoft Double Roman
- Lagan Double Roll
- FP McCann Double Roman

USE

- On roofs with Double Roman tiles
- For direct roof space ventilation
- Connected to a ducted ventilation system inside the building



20° min. pitch

10,000mm² free ventilation area

Replaces 1 Double Roman tile

UV stabilised PP top

DESCRIPTION	COLOUR	SINGLE CODE	MULTI CODE	MULTI QUANTITY	PALLET QUANTITY	LEAD TIME
Double Roman	Terracotta	RTV-DRTE	RTVMULTI-DRTE	6	102	Next Working Day
Double Roman	Brown	RTV-DRBR	RTVMULTI-DRBR	6	102	Next Working Day
Double Roman	Grey	RTV-DRGR	RTVMULTI-DRGR	6	102	Next Working Day
Double Roman	Red	RTV-DRRD	RTVMULTI-DRRD	6	102	Next Working Day

FLAT EDGE

bre

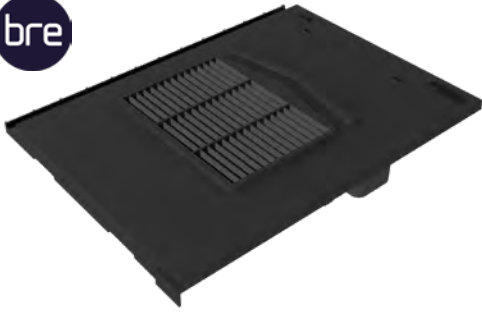

COMPATIBILITY

Flat Edge large format tiles from all major manufacturers including:

- Sandtoft Calderdale Edge
- Sandtoft Danum

USE

- On roofs with Flat Edge tiles
- For direct roof space ventilation
- Connected to a ducted ventilation system inside the building



20° min. pitch



10,000mm² free ventilation area



Replaces 1 Flat Edge tile



UV stabilised PP top

DESCRIPTION	COLOUR	SINGLE CODE	MULTI CODE	MULTI QUANTITY	PALLET QUANTITY	LEAD TIME
Flat Edge	Terracotta	RTV-FETE	RTVMULTI-FETE	8	136	Next Working Day
Flat Edge	Brown	RTV-FEBR	RTVMULTI-FEBR	8	136	Next Working Day
Flat Edge	Grey	RTV-FEGR	RTVMULTI-FEGR	8	136	Next Working Day
Flat Edge	Red	RTV-FERD	RTVMULTI-FERD	8	136	Next Working Day
Flat Edge	Black	RTV-FEBL	RTVMULTI-FEBL	8	136	Next Working Day

NON-PROFILE

bre

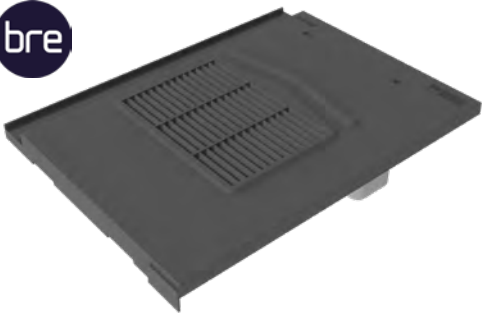

COMPATIBILITY

Non-Profile large format tiles from all major manufacturers including:

- Marley Modern
- Marley Duo Modern
- Redland Mini Stonewold
- Sandtoft Calderdale
- Russell Grampian
- Russell Highland
- Lagan Flat

USE

- On roofs with Non-Profile tiles
- For direct roof space ventilation
- Connected to a ducted ventilation system inside the building



20° min. pitch



10,000mm² free ventilation area



Replaces 1 Non-Profile tile



UV stabilised PP top

DESCRIPTION	COLOUR	SINGLE CODE	MULTI CODE	MULTI QUANTITY	PALLET QUANTITY	LEAD TIME
Non-Profile	Terracotta	RTV-NPTE	RTVMULTI-NPTE	8	136	Next Working Day
Non-Profile	Brown	RTV-NPBR	RTVMULTI-NPBR	8	136	Next Working Day
Non-Profile	Grey	RTV-NPGR	RTVMULTI-NPGR	8	136	Next Working Day
Non-Profile	Red	RTV-NPRD	RTVMULTI-NPRD	8	136	Next Working Day
Non-Profile	Black	RTV-NPBL	RTVMULTI-NPBL	8	136	Next Working Day

THIN LEADING EDGE

bre



COMPATIBILITY

Thin Leading Edge large format tiles from all major manufacturers including:

- Marley Edgemere
- Redland Richmond
- Sandtoft TLE
- Russell Bute
- Russell Galloway
- Lagan Elite
- FP McCann Thin Flat Tile
- FP McCann Duo Thin Flat Tile

USE

- On roofs with Thin Leading Edge tiles
- For direct roof space ventilation
- Connected to a ducted ventilation system inside the building



20° min. pitch



10,000mm² free ventilation area



Replaces 1 TLE tile



UV stabilised PP top

DESCRIPTION	COLOUR	SINGLE CODE	MULTI CODE	MULTI QUANTITY	PALLET QUANTITY	LEAD TIME
Thin Leading Edge	Terracotta	RTV-TETE	RTVMULTI-TETE	8	136	Next Working Day
Thin Leading Edge	Brown	RTV-TEBR	RTVMULTI-TEBR	8	136	Next Working Day
Thin Leading Edge	Grey	RTV-TEGR	RTVMULTI-TEGR	8	136	Next Working Day
Thin Leading Edge	Red	RTV-TERD	RTVMULTI-TERD	8	136	Next Working Day
Thin Leading Edge	Black	RTV-TEBL	RTVMULTI-TEBL	8	136	Next Working Day

INVENTIVE

Roof ventilation solutions

TILE VENTS

Available in single, multi and pallet quantities
Multi = X vents in 1 box (order as each using multi code)



MINI CASTELLATED



COMPATIBILITY

Mini Castellated small format tiles from all major manufacturers including:

- Marley Ludlow Plus
- Redland 49
- Sandtoft Standard Pattern
- Forticrete V2

USE

- On roofs with Mini Castellated tiles
- For direct roof space ventilation
- Connected to a ducted ventilation system inside the building



17.5° min. pitch

5,000mm² free ventilation area

Replaces 1 Mini Castellated tile

UV stabilised PP top

DESCRIPTION	COLOUR	SINGLE CODE	MULTI CODE	MULTI QUANTITY	PALLET QUANTITY	LEAD TIME
Mini Castellated	Terracotta	RTV-MCTE	RTVMULTI-MCTE	14	238	Next Working Day
Mini Castellated	Brown	RTV-MCBB	RTVMULTI-MCBB	14	238	Next Working Day
Mini Castellated	Grey	RTV-MCGR	RTVMULTI-MCGR	14	238	Next Working Day
Mini Castellated	Red	RTV-MCRD	RTVMULTI-MCRD	14	238	Next Working Day

SINGLE PANTILE



COMPATIBILITY

Single Pantile small format tiles from all major manufacturers including:

- Marley Anglia
- Redland Fenland Pantile
- Sandtoft Shire

USE

- On roofs with Single Pantile tiles
- For direct roof space ventilation
- Connected to a ducted ventilation system inside the building



20° min. pitch

5,000mm² free ventilation area

Replaces 1 Single Pantile tile

UV stabilised PP top

DESCRIPTION	COLOUR	SINGLE CODE	MULTI CODE	MULTI QUANTITY	PALLET QUANTITY	LEAD TIME
Single Pantile	Terracotta	RTV-SPTE	RTVMULTI-SPTE	11	187	Next Working Day
Single Pantile	Brown	RTV-SPBR	RTVMULTI-SPBR	11	187	Next Working Day
Single Pantile	Grey	RTV-SPGR	RTVMULTI-SPGR	11	187	Next Working Day
Single Pantile	Red	RTV-SPRD	RTVMULTI-SPRD	11	187	Next Working Day

INTERLOCKING PLAIN

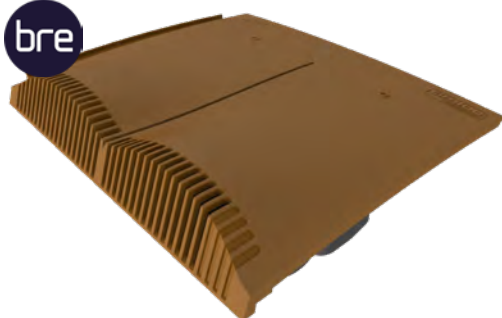

COMPATIBILITY

Interlocking Plain tiles from all major manufacturers including:

- Marley Ashmore
- Redland Duoplain
- Forticrete Gemini

USE

- On roofs with Interlocking Plain tiles
- For direct roof space ventilation
- Connected to a ducted ventilation system inside the building



22.5° min. pitch

6,000mm² free ventilation area

Replaces 1 Interlock Plain tile

UV stabilised PP top

DESCRIPTION	COLOUR	SINGLE CODE	MULTI CODE	MULTI QUANTITY	PALLET QUANTITY	LEAD TIME
Interlocking Plain	Terracotta	RTV-IPTE	RTVMULTI-IPTE	12	204	Next Working Day
Interlocking Plain	Brown	RTV-IPBR	RTVMULTI-IPBR	12	204	Next Working Day
Interlocking Plain	Grey	RTV-IPGR	RTVMULTI-IPGR	12	204	Next Working Day
Interlocking Plain	Red	RTV-IPRD	RTVMULTI-IPRD	12	204	Next Working Day

PLAIN

bre



COMPATIBILITY

Plain tiles from all major manufacturers including:

- Redland Rosemary
- Marley Plain
- Russell Traditional Plain
- Sandtoft Humber Plain

USE

- On roofs with Plain tiles
- For direct roof space ventilation
- Connected to a ducted ventilation system inside the building



35° min. pitch

7,000mm² free ventilation area

Replaces 3 Plain tiles

UV stabilised PP top

DESCRIPTION	COLOUR	SINGLE CODE	MULTI CODE	MULTI QUANTITY	PALLET QUANTITY	LEAD TIME
Plain	Terracotta	RTV-PTE	RTVMULTI-PTE	14	238	Next Working Day
Plain	Brown	RTV-PBR	RTVMULTI-PBR	14	238	Next Working Day
Plain	Grey	RTV-PGR	RTVMULTI-PGR	14	238	Next Working Day
Plain	Red	RTV-PRD	RTVMULTI-PRD	14	238	Next Working Day

LOW PROFILE PLAIN

bre

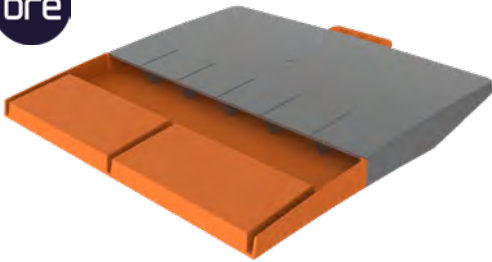

COMPATIBILITY

Plain tiles from all major manufacturers including:

- Redland Rosemary
- Marley Plain
- Russell Traditional Plain
- Sandtoft Humber Plain

USE

- On roofs with Plain tiles
- For direct roof space ventilation
- Connected to a ducted ventilation system inside the building



35° min. pitch

6,100mm² free ventilation area

Replaces 2 Plain tiles

UV stabilised PP top

DESCRIPTION	COLOUR	SINGLE CODE	MULTI CODE	MULTI QUANTITY	PALLET QUANTITY	LEAD TIME
Low Profile Plain	Terracotta	RTV-LPPTE	RTVMULTI-LPPTE	14	238	Next Working Day
Low Profile Plain	Brown	RTV-LPPBR	RTVMULTI-LPPBR	14	238	Next Working Day
Low Profile Plain	Grey	RTV-LPPGR	RTVMULTI-LPPGR	14	238	Next Working Day
Low Profile Plain	Red	RTV-LPPRD	RTVMULTI-LPPRD	14	238	Next Working Day

SLIP PLAIN

bre

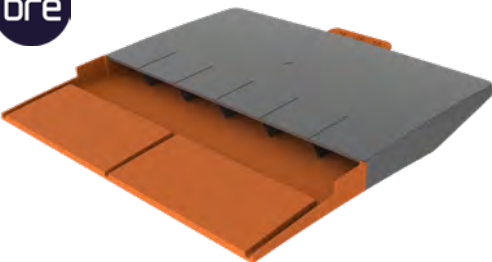

COMPATIBILITY

Plain tiles from all major manufacturers including:

- Redland Rosemary
- Marley Plain
- Russell Traditional Plain
- Sandtoft Humber Plain

USE

- On roofs with Plain tiles
- For direct roof space ventilation
- Connected to a ducted ventilation system inside the building



35° min. pitch

6,100mm² free ventilation area

Replaces 2 Plain tiles

UV stabilised PP top

DESCRIPTION	COLOUR	SINGLE CODE	MULTI CODE	MULTI QUANTITY	PALLET QUANTITY	LEAD TIME
Slip Plain	Terracotta	RTV-SLIPTE	RTVMULTI-SLIPTE	14	238	Next Working Day
Slip Plain	Brown	RTV-SLIPBR	RTVMULTI-SLIPBR	14	238	Next Working Day
Slip Plain	Grey	RTV-SLIPGR	RTVMULTI-SLIPGR	14	238	Next Working Day
Slip Plain	Red	RTV-SLIPRD	RTVMULTI-SLIPRD	14	238	Next Working Day

INVENTIVE

Roof ventilation solutions

TILE VENTS

Available in single, multi and pallet quantities
Multi = X vents in 1 box (order as each using multi code)



UNIVERSAL



COMPATIBILITY

All types of tile or slate roof covering - Alternative lead flashing.

- 170mm Ø = 20,000mm²
- 150mm Ø = 16,000mm²
- 125mm Ø = 11,000mm²
- 110mm Ø = 8,400mm²

USE

- On roofs with any tile or slate
- For direct roof space ventilation
- Connected to a ducted ventilation system inside the building



- 12.5° min. pitch
- 20,000mm² free ventilation area
- Replaces 1 tile or slate
- UV stabilised PP top

DESCRIPTION	COLOUR	SINGLE CODE	MULTI CODE	MULTI QUANTITY	PALLET QUANTITY	LEAD TIME
Universal	Terracotta	RTV-UNITE	RTVMULTI-UNITE	4	60	Next Working Day
Universal	Brown	RTV-UNIBR	RTVMULTI-UNIBR	4	60	Next Working Day
Universal	Grey	RTV-UNIGR	RTVMULTI-UNIGR	4	60	Next Working Day
Universal	Red	RTV-UNIRD	RTVMULTI-UNIRD	4	60	Next Working Day
Universal	Black	RTV-UNIBL	RTVMULTI-UNIBL	4	60	Next Working Day

UNIVERSAL 22,000



COMPATIBILITY

All types of tile or slate roof covering - Alternative lead flashing.

- 170mm Ø = 22,000mm²
- 150mm Ø = 16,000mm²
- 125mm Ø = 11,000mm²
- 110mm Ø = 8,400mm²

USE

- On roofs with any tile or slate
- For direct roof space ventilation
- Connected to a ducted ventilation system inside the building



- 12.5° min. pitch
- 22,000mm² free ventilation area
- Replaces 1 tile or slate
- UV stabilised PP top

DESCRIPTION	COLOUR	SINGLE CODE	MULTI CODE	MULTI QUANTITY	PALLET QUANTITY	LEAD TIME
Universal 22,000	Terracotta	RTV-UNI2TE	RTVMULTI-UNI2TE	4	60	Next Working Day
Universal 22,000	Brown	RTV-UNI2BR	RTVMULTI-UNI2BR	4	60	Next Working Day
Universal 22,000	Grey	RTV-UNI2GR	RTVMULTI-UNI2GR	4	60	Next Working Day
Universal 22,000	Red	RTV-UNI2RD	RTVMULTI-UNI2RD	4	60	Next Working Day
Universal 22,000	Black	RTV-UNI2BL	RTVMULTI-UNI2BL	4	60	Next Working Day

INVENTIVE

Roof ventilation solutions

SLATE VENTS

Available in single, multi and pallet quantities*
Multi = X vents in 1 box (order as each using multi code)

*Excludes 4001. Available in pack quantities only.



UNIVERSAL INLINE SLATE



COMPATIBILITY

Natural or Synthetic slates from all major manufacturers in sizes:

- 300 x 600mm (WxH)
- 250 x 500mm (WxH)

USE

- On Natural or Synthetic Slate roofs
- For direct roof space ventilation
- Connected to a ducted ventilation system inside the building



22.5° min. pitch

9,450mm² free ventilation area

Replaces 1 slate

DESCRIPTION	COLOUR	SINGLE CODE	MULTI CODE	MULTI QUANTITY	PALLET QUANTITY	LEAD TIME
Inline Slate	Black	RTV-ISBL	RTVMULTI-ISBL	5	120	Next Working Day

SMALL INLINE SLATE

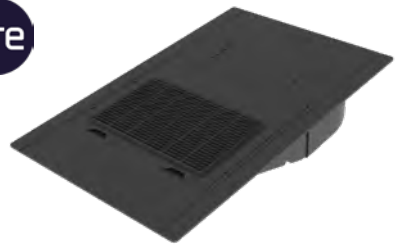

COMPATIBILITY

Natural or Synthetic slates from all major manufacturers in sizes:

- 400 x 250mm (WxH)
- 400 x 225mm (WxH)
- 400 x 200mm (WxH)
- 350 x 250mm (WxH)
- 350 x 200mm (WxH)
- 300 x 200mm (WxH)

USE

- On Natural or Synthetic Slate roofs
- For direct roof space ventilation
- Connected to a ducted ventilation system inside the building



22.5° min. pitch

9,450mm² free ventilation area

Replaces 1 slate

DESCRIPTION	COLOUR	SINGLE CODE	MULTI CODE	MULTI QUANTITY	PALLET QUANTITY	LEAD TIME
Small Inline	Black	RTV-SISBL	RTVMULTI-SISBL	5	120	Next Working Day

HOODED SLATE

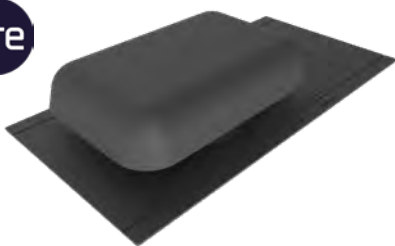

COMPATIBILITY

Natural or Synthetic slates from all major manufacturers in sizes:

- 300 x 600mm (WxH)
- 250 x 500mm (WxH)

USE

- On Natural or Synthetic Slate roofs
- For direct roof space ventilation
- Connected to a ducted ventilation system inside the building



22.5° min. pitch

22,000mm² free ventilation area

Replaces 1 slate

UV stabilised PP top

DESCRIPTION	COLOUR	SINGLE CODE	MULTI CODE	MULTI QUANTITY	PALLET QUANTITY	LEAD TIME
Hooded Slate	Black	RTV-HSBL	RTVMULTI-HSBL	4	68	Next Working Day

UNIVERSAL HOODED SLATE

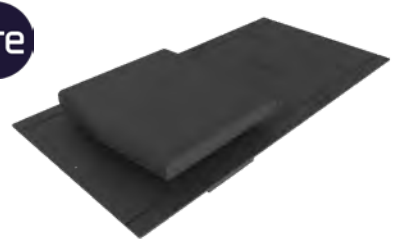

COMPATIBILITY

Natural or Synthetic slates from all major manufacturers in sizes:

- 300 x 600mm (WxH)
- 250 x 500mm (WxH)

USE

- On Natural or Synthetic Slate roofs
- For direct roof space ventilation
- Connected to a ducted ventilation system inside the building



22.5° min. pitch

10,000mm² free ventilation area

Replaces 1 slate

DESCRIPTION	COLOUR	SINGLE CODE	PACK QUANTITY	PALLET QUANTITY	LEAD TIME
Universal Hooded	Black	4001	5	120	Next Working Day

ADAPTERS & ACCESSORIES

Compatible accessories for connection to ventilation ducts or soil vent pipes.

10 YEAR
GUARANTEE

timloc

EPD
AVAILABLE

STANDARD ADAPTER RTV-ADS

110mm connection for ventilation ducts or soil vent pipes



COMPATIBILITY

- CASTELLATED
- DOUBLE PANTILE
- DOUBLE ROMAN
- FLAT EDGE
- NON-PROFILE
- THIN LEADING EDGE

PLAIN ADAPTER RTV-ADP

110mm connection for ventilation ducts or soil vent pipes



COMPATIBILITY

- INTERLOCKING PLAIN
- PLAIN
- LOW PROFILE PLAIN
- SLIP PLAIN

INLINE SLATE ADAPTER RTV-ADIS

110mm connection for ventilation ducts or soil vent pipes

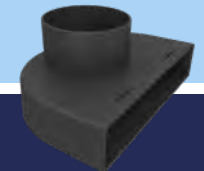

COMPATIBILITY

- INLINE SLATE
- SMALL INLINE SLATE

HOODED SLATE ADAPTER RTV-ADHS

110mm connection for ventilation ducts or soil vent pipes



COMPATIBILITY

- HOODED SLATE

MULTI STEPPED DUCT ADAPTER RTV-ADMULTI

Connection for various sizes of ventilation duct

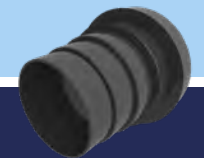

COMPATIBILITY

- STANDARD ADAPTER
- PLAIN ADAPTER
- INLINE SLATE ADAPTER
- 110MM FLEXI-PIPE

DESCRIPTION	PRODUCT CODE	BOX QUANTITY	LEAD TIME
Standard Tile Vent Adapter	RTV-ADS	12	Next Working Day
Plain Tile Vent Adapter	RTV-ADP	12	Next Working Day
Hooded Slate Vent Adapter	RTV-ADHS	10	Next Working Day
Inline Slate Vent Adapter	RTV-ADIS	10	Next Working Day
Multi Stepped Duct Adapter	RTV-ADMULTI	10	Next Working Day

Compatibility chart for the full range of accessories available in the InVentive tile and slate vent range.

Tile / Slate Vent Type		Compatible Accessory Options		
TILE / SLATE VENT	PRODUCT CODE	COMPATIBLE ACCESSORIES	PRODUCT CODE	PACK QUANTITY
Castellated	RTV-C	Standard Adapter	RTV-ADS	12
Double Pantile	RTV-DP	Multi Adapter	RTV-ADMULTI	10
Double Roman	RTV-DR			
Flat Edge	RTV-FE	Flexi-Pipe + Clamp	RTV-KIT1	1
Non-Profile	RTV-NP	Flexi-Pipe + Clamp + Standard Adapter	RTV-KIT2	1
Thin Leading Edge	RTV-TE			
Mini Castellated	RTV-MC	Multi Adapter	RTV-ADMULTI	10
Single Pantile	RTV-SP	Flexi-Pipe + Clamp	RTV-KIT1	1
Plain	RTV-P	Plain Adapter	RTV-ADP	12
Interlocking Plain	RTV-IP	Multi Adapter	RTV-ADMULTI	10
Low Profile Plain	RTV-LPP	Flexi-Pipe + Clamp	RTV-KIT1	1
Slip Plain	RTV-SLIP	Flexi-Pipe + Clamp + Plain Adapter	RTV-KIT3	1
Universal	RTV-UNI	Flexi-Pipe + Clamp	RTV-KIT1	1
Universal 22,000mm²	RTV-UNI2			
Universal Inline Slate	RTV-IS	Inline Slate Adapter	RTV-ADIS	10
		Multi Adapter	RTV-ADMULTI	10
Small Inline Slate	RTV-SIS	Flexi-Pipe + Clamp	RTV-KIT1	1
		Flexi-Pipe + Clamp + Inline Slate Adapter	RTV-KIT4	1
Hooded Slate	RTV-HS	Hooded Slate Adapter	RTV-ADHS	10
		Flexi-Pipe + Clamp	RTV-KIT1	1
Universal Hooded Slate	4001	Pipe Adapter + Flexible PVC Pipe	4101	1
		Pipe Adapter only	4102	1
		Flexible PVC Pipe only	4103	1



FLEXI-PIPE KITS

To connect vents to 110mm ventilation duct or soil vent pipe

The 110mm Flexi-Pipe Kits are also compatible with the Multi Stepped Duct Adapter (RTV-ADMULTI)

 <p>RTV-KIT1 FLEXI-PIPE ONLY</p>	 <p>RTV-KIT2 with STANDARD ADAPTER</p>	 <p>RTV-KIT3 with PLAIN ADAPTER</p>	 <p>RTV-KIT4 with INLINE SLATE ADAPTER</p>
<p>KIT CONTAINS:</p> <ul style="list-style-type: none"> • 1 x Flexi-Pipe • 1 x Screw Clamp 	<p>KIT CONTAINS:</p> <ul style="list-style-type: none"> • 1 x Flexi-Pipe • 1 x Screw Clamp • 1 x Standard Adapter 	<p>KIT CONTAINS:</p> <ul style="list-style-type: none"> • 1 x Flexi-Pipe • 1 x Screw Clamp • 1 x Plain Adapter 	<p>KIT CONTAINS:</p> <ul style="list-style-type: none"> • 1 x Flexi-Pipe • 1 x Screw Clamp • 1 x Inline Slate
<p>COMPATIBLE WITH:</p> <ul style="list-style-type: none"> • RTV-MC • RTV-SP 	<p>COMPATIBLE WITH:</p> <ul style="list-style-type: none"> • RTV-C • RTV-DR • RTV-FE 	<p>COMPATIBLE WITH:</p> <ul style="list-style-type: none"> • RTV-DP • RTV-TE • RTV-NP 	<p>COMPATIBLE WITH:</p> <ul style="list-style-type: none"> • RTV-P • RTV-IP • RTV-LPP • RTV-SLIP • RTV-IS • RTV-SIS

DESCRIPTION	PRODUCT CODE	BOX QUANTITY	LEAD TIME
Flexi-Pipe + Clamp	RTV-KIT1	1	Next Working Day
Flexi-Pipe + RTV-ADS + Clamp	RTV-KIT2	1	Next Working Day
Flexi-Pipe + RTV-ADP + Clamp	RTV-KIT3	1	Next Working Day
Flexi-Pipe + RTV-ADIS + Clamp	RTV-KIT4	1	Next Working Day

INVENTIVE PRODUCT RANGE BREAKDOWN

Roof ventilation solutions Available Colours: ● Terracotta (TE) ● Brown (BR) ● Red (RD) ● Grey (GR) ● Black (BL)

Vent	Image	Compatibility	Min. Pitch°	Free Vent Area	Colours	Accessories	Code	Page
Castellated		FP McCann Square Top Lagan Square Top Marley Ludlow Major Redland Renown Russell Cheviot Sandtoft Lindum	20°	10,000mm ²	● ● ● ● ●	RTV-ADS RTV-ADMULTI RTV-KIT1	RTV-C	84
Double Pantile		Marley Mendip Quinn Locherne Redland Grovebury Redland Landmark Russell Pennine	20°	10,000mm ²	● ● ● ● ●	RTV-ADS RTV-ADMULTI RTV-KIT1	RTV-DP	84
Double Roman		FP McCann Double Roman Lagan Double Roll Marley Double Roman Redland 50 Double Roman Russell Double Roman Sandtoft Double Roman	20°	10,000mm ²	● ● ● ● ●	RTV-ADS RTV-ADMULTI RTV-KIT1	RTV-DR	84
Flat Edge		Sandtoft Calderdale Edge Sandtoft Danum	20°	10,000mm ²	● ● ● ● ● ●	RTV-ADS RTV-ADMULTI RTV-KIT1	RTV-FE	85
Non-Profile		Lagan Flat Marley Duo Modern Marley Modern Redland Mini Stonewold Russell Grampian Russell Highland Sandtoft Calderdale	20°	10,000mm ²	● ● ● ● ● ●	RTV-ADS RTV-ADMULTI RTV-KIT1	RTV-NP	85
Thin Leading Edge		FP McCann Thin Flat Tile FP McCann Duo Thin Flat Tile Lagan Elite Marley Edgemere Redland Richmond Russell Bute Russell Galloway Sandtoft TLE	20°	10,000mm ²	● ● ● ● ● ●	RTV-ADS RTV-ADMULTI RTV-KIT1	RTV-TE	85
Mini Castellated		Forticrete V2 Marley Ludlow Plus Redland 49 Sandtoft Standard Pattern	17.5°	5,000mm ²	● ● ● ● ●	RTV-ADMULTI RTV-KIT1	RTV-MC	86
Single Pantile		Marley Anglia Redland Fenland Pantile Sandtoft Shire	20°	5,000mm ²	● ● ● ● ●	RTV-ADMULTI RTV-KIT1	RTV-SP	86
Interlocking Plain		Forticrete Gemini Marley Ashmore Redland Duoplain	22.5°	6,000mm ²	● ● ● ● ●	RTV-ADP RTV-ADMULTI RTV-KIT1	RTV-IP	86
Plain		Redland Rosemary Marley Plain Russell Traditional Plain Sandtoft Humber Plain	35°	7,000mm ²	● ● ● ● ●	RTV-ADP RTV-ADMULTI RTV-KIT1	RTV-P	87
Low Profile Plain		Redland Rosemary Marley Plain Russell Traditional Plain Sandtoft Humber Plain	35°	6,100mm ²	● ● ● ● ●	RTV-ADP RTV-ADMULTI RTV-KIT1	RTV-LPP	87
Slip Plain		Redland Rosemary Marley Plain Russell Traditional Plain Sandtoft Humber Plain	35°	6,100mm ²	● ● ● ● ●	RTV-ADP RTV-ADMULTI RTV-KIT1	RTV-SLIP	87
Universal		Customisable fit to a wide range of profiled and plain tiles using alternative flashing sheet	12.5°	20,000mm ² (170mm Ø) 16,000mm ² (150mm Ø) 11,000mm ² (125mm Ø) 8,400mm ² (110mm Ø)	● ● ● ● ● ●	RTV-KIT1	RTV-UNI	88
Universal 22,000mm ²		Customisable fit to a wide range of profiled and plain tiles using alternative flashing sheet	12.5°	22,000mm ² (170mm Ø) 16,000mm ² (150mm Ø) 11,000mm ² (125mm Ø) 8,400mm ² (110mm Ø)	● ● ● ● ● ●	RTV-KIT1	RTV-UNI2	88
Universal Inline Slate		600 x 300mm slates 500 x 250mm slates	22.5°	9,450mm ²	●	RTV-ADIS RTV-ADMULTI RTV-KIT1	RTV-IS	89
Small Inline Slate		Small slates 300 x 200mm to 400 x 250mm	22.5°	9,450mm ²	●	RTV-ADIS RTV-ADMULTI RTV-KIT1	RTV-SIS	89
Hooded Slate		600 x 300mm slates 500 x 250mm slates	22.5°	22,000mm ²	●	RTV-ADHS RTV-KIT1	RTV-HS	89
Universal Hooded Slate		600 x 300mm slates 500 x 250mm slates	22.5°	10,000mm ²	●	4101 Pipe Adapter Kit	4001	89

M E T E R

B O X E S

by **timloc**

Gas, electric, surface mounted and **recessed** meter boxes.

ELECTRIC - RECESSED	94
ELECTRIC - SURFACE MOUNTED	94
ELECTRIC - 3 PHASE RECESSED	94
ELECTRIC - 3 PHASE MOUNTED	94
GAS - RECESSED	95
GAS - SURFACE MOUNTED	95
GAS - UNIVERSAL SMART	95
HOCKEY STICKS	95
REPLACEMENT PARTS	95



**SCAN TO VIEW
THE RANGE ONLINE**



ELECTRIC

Meter Boxes by Timloc are available for domestic use and are manufactured from hot-pressed, glass-reinforced plastic, making them hard-wearing and weather-resistant.



RECESSED

USE

- Designed to house UK standard domestic electric meters
- Recessed dimensions: 530 x 363 x 150mm

SURFACE MOUNTED

USE

- Designed to house UK standard domestic electric meters



3 PHASE RECESSED

USE

- Designed to house UK 3 phase electric meters



3 PHASE SURFACE MOUNTED

USE

- Designed to house UK 3 phase electric meters



DESCRIPTION	OVERALL DIMENSIONS	PRODUCT CODE	BOX QTY	PACK QTY	LEAD TIME
Electric Meter Box - Recessed	594 x 409 x 210mm	30011	1	N/A	Next Working Day
Electric Meter Box - Surface Mounted	595 x 410 x 220mm	30012	1	N/A	Next Working Day
Electric Meter Box 3 Phase - Recessed	794 x 565 x 180mm	30002	N/A	4	Next Working Day
Electric Meter Box 3 Phase - Surface Mounted	794 x 565 x 190mm	30003	N/A	2	Next Working Day

GAS



RECESSED

USE

- Designed to house UK standard domestic single phase gas meters
- Recessed dimensions: 530 x 363 x 150mm

SURFACE MOUNTED

USE

- Designed to house UK standard domestic single phase gas meters



UNIVERSAL SMART

USE

- Designed to house UK standard domestic smart gas meters

DESCRIPTION	DIMENSIONS	PRODUCT CODE	BOX QTY	LEAD TIME
Gas Meter Box - Recessed	595 x 409 x 214mm	30013	1	Next Working Day
Gas Meter Box - Surface Mounted	510 x 408 x 242mm	30015	1	Next Working Day
Gas Meter Box - Universal Smart	500 x 474 x 303mm	30017	1	Next Working Day

ACCESSORIES & SPARES

REPAIR KITS



SPARE DOORS



HOCKEY STICKS



DESCRIPTION	DIMENSIONS	PRODUCT CODE	PACK QTY	LEAD TIME
Internal Hockey Stick	1200 x 480 x 38mm	31001	1	Next Working Day
Surface Mounted Hockey Stick	1450 x 310 x 38mm	31002	1	Next Working Day
Replacement Door - Electric Meter Box - Recessed & Surface Mounted	549 x 383mm	30008	1	Next Working Day
Replacement Door - Gas Meter Box - Recessed	549 x 383mm	30014	1	Next Working Day
Replacement Door - Gas Meter Box - Surface Mounted	340 x 380mm	30016	1	Next Working Day
Replacement Door - Universal Gas Meter Box	549 x 383mm	30018	1	Next Working Day
Gas Meter Box Repair Kit	NA	30022	1	Next Working Day
Electric Meter Box Repair Kit	NA	30027	1	Next Working Day

HEDGEHOG HIGHWAY

by **timloc**

Helping **hedgehogs** roam
from garden to garden

Hedgehogs are classified as **vulnerable to extinction** and listed as a species of principal importance. The population of hedgehogs in Great Britain is estimated below 1 million, compared to over 30 million in the 1950s. **Loss of habitat** is one of the contributing factors in their reducing numbers.

The Hedgehog Highway by Timloc is designed to connect gardens, enabling hedgehogs to roam freely and forage for food and shelter without restriction.

Timloc Building Products has **donated over £4,000** so far to hedgehog charities and rescues across the UK from proceeds of the Hedgehog Highway.

Hedgehog Highway is manufactured using recycled plastic and packaging is 100% recyclable.



SCAN TO VISIT
THE WEBSITE



USE

- To frame fence holes designed to connect gardens, enabling hedgehogs to roam freely and forage for food and shelter without restriction

DIMENSIONS

- Product: 183mm (H) x 3mm (W) x 265mm (L)
- Hole: 130mm (H) x 130mm (L)

HEDGEHOG HIGHWAY

by **timloc**



PRODUCT CODE	COLOUR	PACK QUANTITY	LEAD TIME
5552	Black	2	Next Working Day
7772	Brown	2	Next Working Day
HOGBLACK	Black	60 (unboxed)	Next Working Day
HOGBROWN	Brown	60 (unboxed)	Next Working Day



Alumasc Building Products Limited (trading as Timloc Building Products)
General Terms and Conditions for the Sales of Goods and Services

The Customer shall ensure that its employees and other staff (including contractors and staff of the Customer's suppliers, service providers and agents) are aware of Alumasc's Privacy Notices at <http://www.alumasc.co.uk/privacy-policy/> and shall ensure that the Privacy Notice is read and understood by such employees and staff before their personal data is provided to Alumasc.

1.1 All orders are accepted subject to the following terms and conditions which shall form part of and govern the Contract of Sale.

1.2 In these conditions the seller means Timloc Building Products trading as an agent for Alumasc Building Products Limited and the buyer means the party to whom this document is addressed.

1.3 These terms and conditions apply in preference to and supersede any terms and conditions referred to or offered by the seller whether in negotiation or at any stage in the dealings between the seller and buyer with reference to the goods to which this contract relates. Without prejudice to the generality of the foregoing, the seller will not be bound by any standard or printed terms furnished by the buyer in any of its documents, unless the buyer specifically states in writing separately from such terms that it intends such terms to apply and the seller acknowledges such notification in writing.

1.4 Neither the buyer nor the seller shall be bound by any variation, waiver of, or addition to these conditions except as agreed by both parties in writing and signed on their behalf.

2. Quotations

2.1 The placing of an order following the seller's quotation shall not be binding on the seller unless and until accepted by the seller in writing. An order accepted by the seller may only be cancelled or varied with the seller's consent; the giving of the seller's consent shall not in anyway prejudice the seller's right to recover from the buyer full compensation for any loss or expense arising from such cancellation or variation.

2.2 Additions or alterations to orders, however made, shall not be binding on the seller until they have been confirmed by the seller in writing.

3. Prices

3.1 The prices quoted are based on current conditions and are subject to adjustment on or after acceptance without notice. The goods will be invoiced at the price ruling on the date of despatch.

3.2 The prices quoted are exclusive of Value Added Tax, unless otherwise specifically stated in the contract. Any variation to prices resulting from taxes or levies will be for the buyer's account.

4. Delivery

4.1 Where goods are ordered by the buyer for delivery at his request:

- if a period is stated for delivery and such period is not extended by agreement in writing the buyer shall take delivery within that period.
- if no period is stated for delivery, the buyer shall take delivery of the goods as soon as they are ready.
- if the buyer does not take delivery of the goods within the period the buyer will reimburse the seller's storage and insurance costs. An invoice will be issued for the full amount of the goods plus storage costs on the last date on which delivery is due and shall be payable in accordance with the provisions of clause 11.1.

4.2 In any other case:

- any time stated in respect of delivery is given in good faith but it is by way of estimation only and is not binding on the seller.
- time for delivery, whether expressly stated or not, shall not be or be deemed to be of the essence of the contract of sale.

4.3 The seller will deliver the goods as near as possible to the delivery address as a safe hard road permits. The buyer shall provide at his own expense the labour for unloading and stacking. The buyer shall unload with utmost despatch. Damage caused to the goods due to inadequate site access or careless unloading shall be at the buyer's expense.

4.4 The seller shall not be liable for any loss or damage whether direct or indirect or consequential (including loss of profit, loss of business, the depletion of goodwill or other economic loss), or in whatsoever way arising which is or might be occasioned to the buyer or to any purchaser from his or a customer's of his arising out of, or in any way due to any delay or default in delivery of any goods under the contract however caused.

4.5 The seller shall be entitled to make partial delivery of the goods unless otherwise agreed in writing.

4.6 In the case of partial delivery of the goods the buyer will not be entitled to treat the delivery of faulty goods in any one partial delivery or the late delivery of any partial delivery as a repudiation of the whole contract.

4.7 By prior arrangement, the seller may accept the return of goods previously delivered to a buyer's branch. A credit note will be issued subject to conditions 4.7 (i) to (vi).

- The buyer must notify the seller of their intention to return the goods no later than three working days from the delivery date.
- Goods must be in their original saleable condition verified by photographic evidence may be required.
- A re-stocking charge of 25% of the original order value will be payable by the buyer.
- The buyer is responsible for returning the goods, at their own expense, to the seller.
- Goods delivered direct to a site operated by the buyer's customer cannot be returned.
- Made to order products cannot be returned.

4.8 Orders of made to order products cannot be cancelled after the order acknowledgment has been sent by the seller.

5. Packing, Consignment and Carriage

5.1 Unless otherwise stated in the contract the goods will be consigned by the method of transport chosen by the seller to the delivery address specified by the buyer for the consignment of the goods ('delivery address' or, where the delivery address is not within the United Kingdom, F.O.B. in a United Kingdom port).

5.2 If packaging is marked 'returnable' it is not included in the price, but will be charged for unless returned within one month, carriage paid and in good condition to the seller's premises.

6. Transfer of Risk

6.1 The goods shall be at the risk of the buyer as soon as they are delivered to the delivery address or where the delivery address is not within the United Kingdom immediately the goods are placed on board a ship unless otherwise agreed in writing.

7. Acceptance of Goods

7.1 The buyer will be deemed to have accepted the goods unless he rejects them within three working days after their receipt at the delivery address.

7.2 The seller shall have no liability for goods delivered in a damaged or defective condition or lost in transit or for shortages in delivery unless:

- in the case of damage or defect or shortage of delivery, details are endorsed by the buyer on the carrier's delivery note or receipt and notice in writing giving full particulars of the damage or defect or shortage is received by the seller and the carrier within three working days after receipt of the goods at the delivery address.
- in the case of goods lost in transit, notice in writing, or by email to sales@timloc.co.uk, of the non-delivery is received by the seller and by the carrier within three working days after the date of the advice note or invoice (as the case may be) issued by the seller.

7.3 If shortage of delivery does take place the buyer undertakes not to reject the goods but to accept the goods delivered as part performance of the contract.

7.4 Subject to the buyer complying with Clauses 7.1 or 7.2 of the above (as the case may be) and subject to Clause 8 below, the seller shall replace or make good any goods rejected by the buyer or delivered in a damaged or defective condition or lost in transit (or in lieu thereof, at the option of the seller, shall allow credit to the buyer of the amount of the price of the goods lost or rejected or a proportionate amount thereof in the case of goods damaged) but the seller shall have no other liability whatsoever (other than liability for death or personal injury due to the seller's negligence) including consequential loss (including loss of profit, loss of business, the depletion of goodwill or other economic loss), in respect of goods rejected by the buyer or delivered in a damaged or defective condition or lost in transit. It shall be the duty of the buyer to insure against such consequential loss and to hold the seller harmless therefore.

7.5 All warranties, conditions and other terms implied by statute or common law (save for the conditions implied by Section 12 of the Sales of Goods Act 1979) are, to the fullest extent permitted by law, excluded from the contract.

7.6 The total amount of any liability under this contract shall be limited to the value of the contract.

8. Specifications

8.1 Unless otherwise specifically stated in the contract all specifications and particulars of weights and dimensions stated in the contract and in the seller's sales literature are approximate only and where dimensions or weights are quoted in imperial measurements the seller reserves the right to supply any convenient metric equivalent or vice versa.

8.2 Whilst every effort is made for these figures to be accurate, it must be understood that the specification of goods manufactured and supplied by the seller is subject to normal trade tolerances.

8.3 The seller reserves the right to change the specification of any goods quoted in its sales literature at any time without notice.

8.4 Whilst the seller takes every precaution in the preparation of its literature, these documents are for the buyer's general guidance only and the particulars contained therein shall not constitute representations by the seller and the seller shall not be bound thereby.

9. Design

9.1 It is the buyer's responsibility to ensure that all necessary approvals have been granted before manufacture commences. The seller will assist in supplying drawings and calculations when requested to do so. No design work or calculations will be issued prior to the placing of a firm order or contract. An additional charge will be made for any design work or drawings required over and above those normally supplied by the seller. It is the buyer's responsibility to satisfy himself that the drawings, calculations and specifications are correct and that the goods are suitable and fit for purpose, as no responsibility for omissions or errors will be accepted by the seller after the buyer has approved details submitted. The placing of an order by the buyer shall be deemed to be acceptance and approval by the buyer of the details submitted. The seller's responsibility in any event is solely confined to its own manufactured components and does not extend to other products or components or overall structural or architectural considerations. Where Timloc products have been offered as "equal or approved" such products may have different features from those shown in original specifications and the purchase by the buyer of such Timloc products under these circumstances shall be deemed to be acceptance of this fact, and remain at the buyer's risk and responsibility.

10. Intellectual Property Rights

10.1 The property and any copyright or other intellectual property rights in any documents or other materials, and any data or other information provided by the Seller relating to the Goods shall (unless otherwise agreed in writing between the Buyer and the Seller) at all times be and remain exclusively in the ownership of the Seller, subject only to a licence in favour of the Buyer to use such documents or materials for the purposes of receiving the Goods.

11. Payment

11.1 Except where otherwise specifically agreed, payment must be made to the seller's address stated on his invoice not later than the last day of the month following the date of invoice.

11.2 Where partial delivery is made the buyer shall be obliged to pay for each instalment separately, if the seller so requires by invoicing him.

11.3 Time for payment is of the essence.

11.4 If payment is not made on the due date the seller shall be entitled to:

- charge interest on the outstanding amount at the rate of 4% above Lloyds Bank Plc base rate accruing daily;
- require payment in advance of delivery of undelivered goods;
- refuse to make delivery of any undelivered goods whether ordered under the contract or not and without incurring any liability whatever to the buyer for non-delivery or any delay in delivery.
- to terminate the contract.
- to enforce the terms of Clauses 11.2 and 11.3

11.5 Unless otherwise agreed in writing by the seller the buyer shall not be entitled to exercise any right of set-off or counterclaim against monies owed to the seller for goods invoiced and delivered to him.

12. Ownership of Goods

12.1 Subject to the following clauses, the goods shall remain the seller's property until payment in full of the price, interest charges and all other monies due to the seller under this contract and all other contracts between the seller and the buyer, notwithstanding any processing of the same or incorporation of the same into a larger piece of equipment or structure.

12.2 The buyer shall be entitled to sell the goods in the ordinary course of business, provided that the proceeds of the sale shall be held in trust for the seller by the buyer until payment of all sums due to the seller by the buyer under this contract and all other contracts between the seller and buyer.

12.3 Should the buyer default in any payment when due the seller will be entitled to repossess all the goods held by the buyer which are still the seller's property (without prejudice to any other right or remedy arising out of such default in payment) and for this purpose the seller will be entitled to enter upon any land or buildings on or in which the goods may be situated and to remove the same. All costs incurred by the seller in repossessing the goods shall be borne by the buyer.

13. Patents

13.1 The buyer shall indemnify the seller against all damages penalties costs and expenses to which the seller may be liable as a result of work done in accordance with the buyer's specification which involves the infringement of any letters patent or registered design.

14. Determination of Contract

14.1 If the buyer shall make default in or commit a breach of the contract or of any other of his obligations to the seller, or the Buyer has a bankruptcy order made against him or makes an arrangement or composition with his creditors, or otherwise takes the benefit of any Act for the time being in force for the relief of insolvent debtors, or (being a body corporate) convenes a meeting of creditors (whether formal or informal), or enters into liquidation (whether voluntary or compulsory) except a solvent voluntary or compulsory) except a solvent voluntary liquidation for the purpose only of reconstruction or amalgamation, or has a receiver and/or manager, administrator or administrative receiver appointed of its undertaking or any part thereof, or a resolution is passed or a petition presented to any court for the winding up of the Buyer or for the granting of an administration order in respect of the Buyer, or any proceedings are commenced relating to the insolvency or possible insolvency of the Buyer; or the Buyer suffers or allows any execution, whether legal or equitable, to be levied on his/its property or obtained against him/it, or fails to observe/performs any of his/its obligations under the Contract or any other contract between the Seller and the Buyer, or is unable to pay its debts within the meaning of section 123 of the Insolvency Act 1986 or the Buyer ceases to trade, the seller shall have the right by written notice to the buyer to determine this and/or any other contract then subsisting between the buyer and the seller, and/or suspend further deliveries of goods under this and/or any other contract between the buyer and the seller. Such right shall be without prejudice to any other claim or right the seller may otherwise make to exercise.

15. Notices

15.1 Notices required to be given to the seller must be in writing and sent by first class post to the address stated on the front of this document. Notices required to be given to the buyer will be sent by first class post to the address specified by the buyer for the consignment of the goods unless a different address is specified for this purpose by the buyer. Notices shall be deemed to have been delivered on the next business day after the day of posting. In proving service by first class post it shall only be necessary to prove that the notice was contained in an envelope which was duly addressed and posted in accordance with this clause.

16. Other Conditions

16.1 No liability will be accepted by the seller for any failure of, or delay in, performance which is due wholly or partially to restriction by Government or other competent authority, strikes, lock-outs, failure by suppliers to supply raw materials or bought in goods or components or to any other cause whatsoever outside the seller's reasonable control.

16.2 Any waiver by the seller of its rights hereunder in respect of breach by the buyer shall not affect the rights of the seller in the event of a subsequent breach by the buyer.

17. Law

17.1 These conditions and the contract shall be subject to and construed in accordance with English Law and the buyer is deemed to submit to the non-exclusive jurisdiction of the English Courts.

GUIDES

Whether you need comprehensive product information or condensed data on a specific category, we will have the guide to suit.

Scan the QR code for digital versions of the Timloc product guide, handbook, category guides and datasheets.

For print copies, please email: sales@timloc.co.uk



Compact **A5 guides** packed with key information, codes and pack quantities.

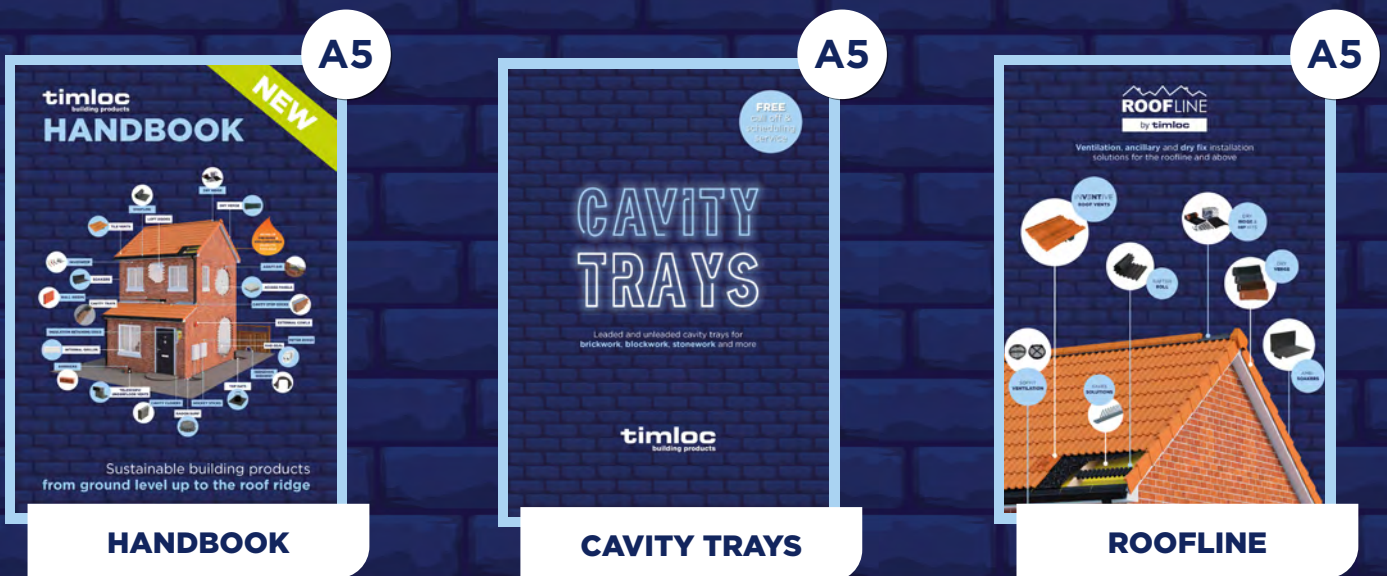

Sustainability Guide explains the steps we've taken towards sustainability.

Product Guide features detailed information, codes and pack quantities.



Timloc House, Ozone Park, Howden, East Yorkshire, DN14 7SD

T: 01405 765 567 **W:** www.timloc.co.uk

Sales: sales@timloc.co.uk

Technical: technical@timloc.co.uk

timloc

building products

2026 | Version 4

Every care has been taken to ensure that this brochure is correct at the time of printing, but Timloc Building Products does not accept responsibility for errors or misinterpretation of data. The customer should satisfy themselves that the products are suitable for their intended purpose. Following its policy of continuing product improvement, Timloc Building Products reserves the right to introduce changes to the specification and modifications of its design at any time without due notice. The customer should satisfy themselves by enquiring with Timloc Building Products if any changes have been introduced since its publication.