



Aero Core

DATASHEET

Anti-Draught Ventilators

Use

- To provide background room ventilation or ventilation for heat producing appliances up to a max input of 24.8kW (84,600 Btu).
- Ideally suited for refurbishment, remedial work or new build.

Features & Benefits

- Aesthetically pleasing and discreet vent and grille options.
- Provides excellent airflow.
- Airflow is easily adjusted by turning the inner section to increase or decrease the opening (adjustable version only).
- The supplied duct is $\varnothing 127\text{mm}$ diameter x 350mm in length and can be trimmed to suit narrower walls as required.
- Integrated baffle giving protection against draughts.
- Optional backplate accessory (code: 25159) designed to cover chipped areas of internal wall during installation and after core drilling (not compatible with internal grille options).
- Backplate dimensions: 210mm x 210mm.
- Reduced light transmission through the ventilator compared to other forms of ventilation.
- Cowl or grille external vent options available.
- The internal vents and grilles are easy to clean and paintable if required to match a coloured wall surface.
- Optional tube accessory (code: ACTUBE) and tube connector (code: 6532) allows installation into walls with a total depth above 350mm.

Material & Colour

- Vents / Grilles / Cowls – HIPS (High Impact Polystyrene) Terracotta / Brown / Buff / White
- Tube / Baffle – PP (Polypropylene) Black

Quality

- Equivalent area tested to BS EN 13141-1:2019 by the BRE
- Compliant with BS 5440-2:2023 & BS 5871-3:2005 & BS 493:1995.
- Complies with Building Regulation Approved Documents F (2010 edition) & J (2010 edition)
- Complies with 'Scottish Building Standards' technical handbook
- Manufactured to BS EN ISO 9001 and BS EN ISO 14001
- Meets the requirements of British Gas
- Satisfies NHBC Standards

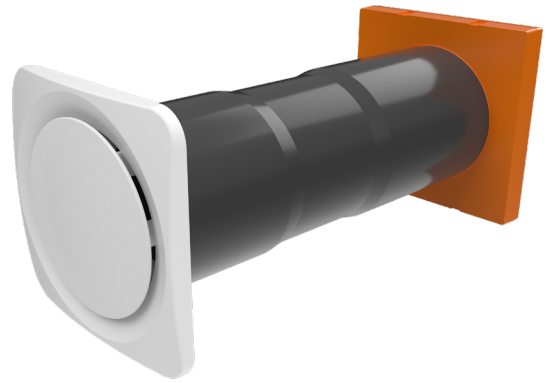

7520TE

Aero Core Adjustable Vent - Baffle - Grille
Terracotta

How to Order

- State the correct anti-draught ventilator for the heating appliance to be vented or the amount of background ventilation required.
- For background ventilation state whether the product should be adjustable or fixed.
- State the required colour of external cowl or grille.

Bill of Quantity

- F30 Accessories/sundry items for brick/block/stone walling
Clause
171 VENTILATION DUCTS
Aesthetically pleasing and discreet vents
- To BS493, Class 1, built in as the work proceeds
 - Manufacturer: Timloc Building Products, Timloc House, Ozone Park, Howden, East Yorkshire, DN14 7SD. T: 01405 765567, W: www.timloc.co.uk
 - Reference: e.g. ACV7BR Timloc Aero Core 5" Vent in Brown 8,000mm² (suit appliance rated output max 23kW)

Product Drawings

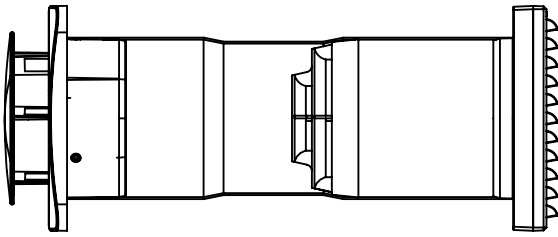

Aero Core Fixed - Baffle - Grille

7500BR / 7500BU / 7500TE / 7500WH

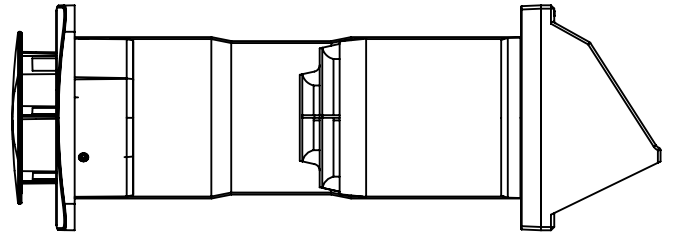

Aero Core Fixed - Baffle - Cowl

7510BR / 7510BU / 7510TE / 7510WH

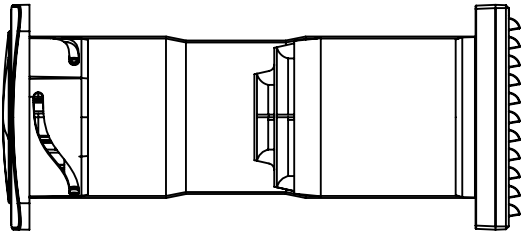

Aero Core Adjustable - Baffle - Grille

7520BR / 7520BU / 7520TE / 7520WH

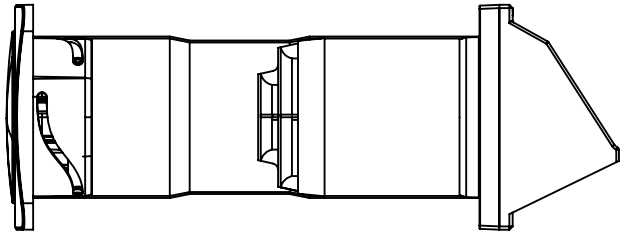

Aero Core Adjustable - Baffle - Cowl

7530BR / 7530BU / 7530TE / 7530WH

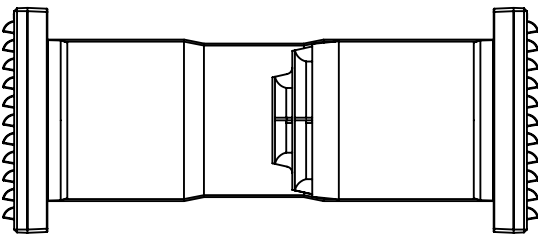

Aero Core Grille - Baffle - Grille

ACV7BR / ACV7TE

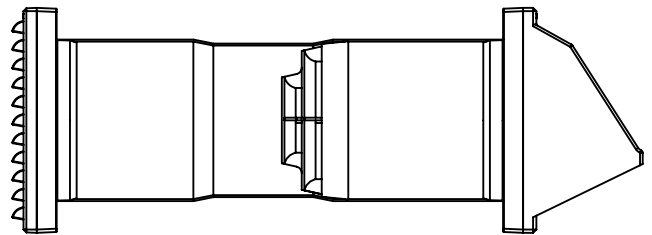

Aero Core Grille - Baffle - Cowl

ACV7CBR / ACV7CTE

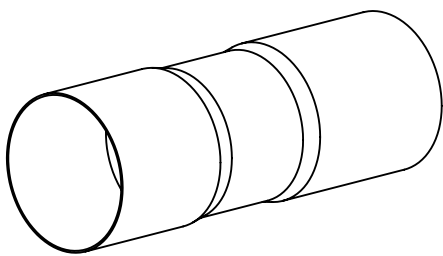

Aero Core Tube Accessory

ACTUBE

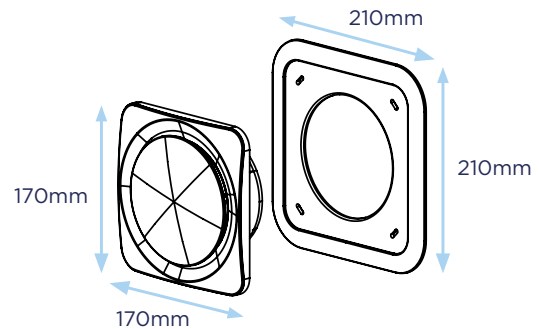

Aero Core Backplate Accessory

25159

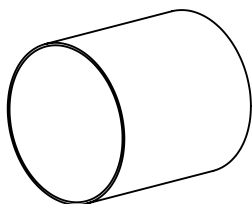

Aero Core Connector Tube

6532

Product Codes

Fixed Vent

Description	Equivalent Area	Appliance Rated Input	External	Colour	Pack Qty	Product Code
5" (127mm) Aero Core Fixed Vent - Baffle	8,000mm ²	23kW (78,500 Btu)	Grille	Terracotta	1	7500TE
5" (127mm) Aero Core Fixed Vent - Baffle	8,000mm ²	23kW (78,500 Btu)	Grille	Brown	1	7500BR
5" (127mm) Aero Core Fixed Vent - Baffle	8,000mm ²	23kW (78,500 Btu)	Grille	Buff	1	7500BU
5" (127mm) Aero Core Fixed Vent - Baffle	8,000mm ²	23kW (78,500 Btu)	Grille	White	1	7500WH
5" (127mm) Aero Core Fixed Vent - Baffle	8,000mm ²	23kW (78,500 Btu)	Cowl	Terracotta	1	7510TE
5" (127mm) Aero Core Fixed Vent - Baffle	8,000mm ²	23kW (78,500 Btu)	Cowl	Brown	1	7510BR
5" (127mm) Aero Core Fixed Vent - Baffle	8,000mm ²	23kW (78,500 Btu)	Cowl	Buff	1	7510BU
5" (127mm) Aero Core Fixed Vent - Baffle	8,000mm ²	23kW (78,500 Btu)	Cowl	White	1	7510WH

Adjustable Vent

Description	Equivalent Area	Appliance Rated Input	External	Colour	Pack Qty	Product Code
5" (127mm) Aero Core Adjustable Vent - Baffle	Up to 8,000mm ²	NA	Grille	Terracotta	1	7520TE
5" (127mm) Aero Core Adjustable Vent - Baffle	Up to 8,000mm ²	NA	Grille	Brown	1	7520BR
5" (127mm) Aero Core Adjustable Vent - Baffle	Up to 8,000mm ²	NA	Grille	Buff	1	7520BU
5" (127mm) Aero Core Adjustable Vent - Baffle	Up to 8,000mm ²	NA	Grille	White	1	7520WH
5" (127mm) Aero Core Adjustable Vent - Baffle	Up to 8,000mm ²	NA	Cowl	Terracotta	1	7530TE
5" (127mm) Aero Core Adjustable Vent - Baffle	Up to 8,000mm ²	NA	Cowl	Brown	1	7530BR
5" (127mm) Aero Core Adjustable Vent - Baffle	Up to 8,000mm ²	NA	Cowl	Buff	1	7530BU
5" (127mm) Aero Core Adjustable Vent - Baffle	Up to 8,000mm ²	NA	Cowl	White	1	7530WH

Grille Vent

Description	Equivalent Area	Appliance Rated Input	External	Colour	Pack Qty	Product Code
5" (127mm) Aero Core Grille Vent - Baffle	8,000mm ²	23kW (78,500 Btu)	Grille	Terracotta	1	ACV7TE
5" (127mm) Aero Core Grille Vent - Baffle	8,000mm ²	23kW (78,500 Btu)	Grille	Brown	1	ACV7BR
5" (127mm) Aero Core Grille Vent - Baffle	8,000mm ²	24.8kW (84,600 Btu)	Cowl	Terracotta	1	ACV7CTE
5" (127mm) Aero Core Grille Vent - Baffle	8,000mm ²	24.8kW (84,600 Btu)	Cowl	Brown	1	ACV7CBR

Accessories

Description	Pack Qty	Product Code
Aero Core Backplate Accessory	1	25159
Aero Core Tube Accessory	1	ACTUBE
Aero Core Connector Tube	1	6532