

INVENTIVE

Roof ventilation solutions

RTV-LPP | Low Profile Plain Tile Vent

DATASHEET

Plain roof tile vent to enable ventilation directly into a roof space or connect to a ducted ventilation system

Use

- On roofs with Plain roof tiles
- Enables ventilation directly into a roof space
- Can also be connected to a ducted ventilation system inside the building

Features & Benefits

- Suitable for roofs with a minimum pitch of 35°
- Free ventilation area of 6,100mm²
- Sized to replace 2 plain tiles to provide a continuous visual appearance along the roof when viewed at all levels
- Shaped to manage rainwater back down onto the roof and away from the vent opening via the three drainage channels
- Internal grille to keep out large insects, vermin and debris
- UV stabilised for continuous exposure to sunlight
- Lightweight and easy to handle

Quality

- Independently tested by BRE for deluge and wind driven rain to PD CEN/TR15601:2012
- BS EN 490:2011 Concrete roofing tiles and fittings for roof covering and wall cladding - product specifications (+A1:2017)
- BS 5250: 2021 Management of moisture in buildings - Code of practice
- BS 5534:2014 Slating and tiling for pitched roofs and vertical cladding - code of practice (+A2:2018)
- Manufactured to BS EN ISO 9001:2015 and BS EN ISO 14001:2015
- Complies with all relevant sections of the Building Regulations 2010
- Satisfies all relevant NHBC requirements

Compatibility

Plain tiles from all major manufacturers including:

- Redland Rosemary
- Marley Plain
- Russell Traditional Plain
- Sandtoft Humber Plain

Material & Colour

- Top - UV stabilised coloured injection moulded Polypropylene with textured finish
- Available in Terracotta, Brown, Grey and Red
- Base - Black injection moulded Polypropylene

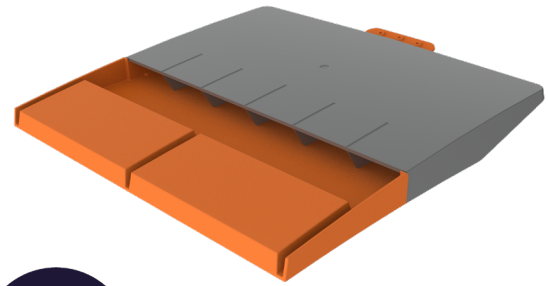

Terracotta
RTV-LPPTE

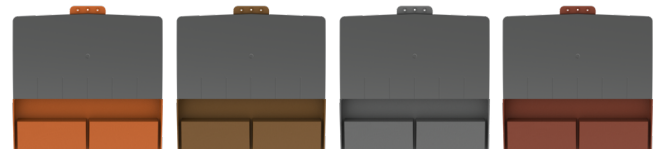

Terracotta
RTV-LPPTE

Brown
RTV-LPPBR

Grey
RTV-LPPGR

Red
RTV-LPPRD

Environmental Product Declaration

A quantification of environmental information regarding the life cycle of the Low Profile Plain Tile Vent. GWP total is for production stages A1-A3. Verified in accordance with ISO 14025. View the full EPD at timloc.co.uk.

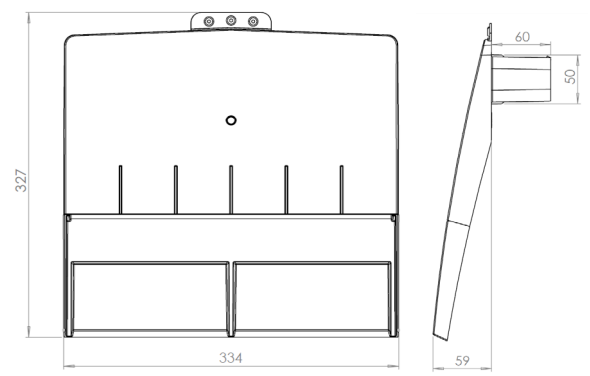

Product	EPD Reference	EPD Mass (KG)	GWP A1-A3 (KG CO ₂ e)
RTV-LPP	EPD HUB, HUB-2425	0.573	2.51E-01

Product Dimensions



Compatible Accessories

- Full datasheets available for all accessories

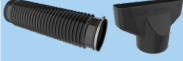
Description	Product Code	Product Image
110mm Flexi-Pipe to aid connection to ventilation duct or soil vent pipe	RTV-KIT1	
Plain adapter to attach the roof tile vent to 110mm ductwork	RTV-ADP	
Multi adapter (RTV-ADMULTI) to aid connection to 100/110/125/150mm duct sizes	RTV-ADMULTI	
RTV-KIT1 and RTV-ADP available as one kit	RTV-KIT3	

Airflow Test Data

RTV-LPP (100mm duct)	
Flow Rate l/s	Static pressure difference Pa
3	1
10	9
18	26
25	51

Product Codes

Product Description	Colour	Weight	Box Quantity	Product Code	Pack Quantity	Pack Code
Low Profile Plain Roof Tile Vent	Terracotta	0.7kg	1	RTV-LPPTE	14	RTVMULTI-LPPTE
Low Profile Plain Roof Tile Vent	Brown	0.7kg	1	RTV-LPPBR	14	RTVMULTI-LPPBR
Low Profile Plain Roof Tile Vent	Grey	0.7kg	1	RTV-LPPGR	14	RTVMULTI-LPPGR
Low Profile Plain Roof Tile Vent	Red	0.7kg	1	RTV-LPPRD	14	RTVMULTI-LPPRD

NB. RTV-LPP available in single, pack or pallet quantities. For pack quantities, 14 tile vent assemblies are packaged in one large box.